

Indhold af elgruppen
Innehåll av elgruppen

	NGK	NGK tændrør	510
		NGK tändstift	510
	NGK	NGK iridium tændrør	510
		NGK iridium tändstift	510
	NGK	NGK tændhætter	539
		NGK tändhättar	539
	CHAMPION	Champion tændrør	528
		Champion tändstift	528
	CHAMPION	Champion tændhætter	538
		Champion tändhättar	538
	NGK	NGK lambda sensor	523
		NGK lambda sensor	523
		Tændspoler	540
		Tändspole	540
		Platiner/kondensatorer	535
		Brytarspetsar/ Kondensatorer	535
		Pick up spole	541
		Pick up spolar	541
		Memjet justerbar indsprøjtning	542
		Memjet justerbar insprutning	542
	TOUR MAX	Frigeaar kontakter	545
		Neutral læges givare	545
	TOUR MAX	Kølevæske temperatur følere	546
		Kylvätsketemperatur mätare	546
	TOUR MAX	Blæser kontakt (køler)	547
		Fläkt kontakt (kylar)	547
	TOUR MAX	Silicone rectifier til Honda	548
		Silicone rectifier för Honda	548
	TOUR MAX	Han- og hunstik	548
		Hane/hona skarvkoppling	548
	EMIGO	Sikringer og -holdere	549
		Säkringar och -hållare	549
	RICE pro	Startermotor, komplet	550
		Startmotor komplett	550
	TOUR MAX	Kawasaki Z1 generatordæksel og stator	557
		Kawasaki Z1 generatorlock och stator	557
	TOUR MAX	Blinkrelæ	551
		Blinkers-relä	551
		Starter- og generatorkul	552
		Startmotor- og generatorkol	552
		Starterkoblings rep.kit	555
		Startkoppling rep.sats	555
		Statorer, svinghjul	557, 558
		Statorer, svänghjul	557, 558
	EMIGO	Tændingslås	562
		Tändningslås	562
		Spændingsregulatorer	585
		Spänningsregulatorer	585
		Start relæ	569
		Start relä	569
	TOUR MAX	Ensretter/voltregulator	575
		Likriktare/voltregulator	575
	TOUR MAX	Bremselyskontakter	596
		Bromsljuskontakter	596
	EMIGO	Horn, universal	602
		Horn, universal	602
	EMIGO	Paraboler og lygtehuse	603
		Strålkastarinsats och lykthus	603
	top lamp	Pærer	607
		Glödlampor	607



Stikord Sökord s. 2-5
Forhandlere Återförsäljare s. 6-9
Tøj/hjelme Kläder/ hjälmnar s. 11
Dæk Däck s. 83
Olie Olja s. 115
Kæde/ tandhjul Kedjor/ drev s. 145
Bremser Broms s. 187
Låse Lås s. 347
Batteri Batterier s. 355
Pakninger Packningar s. 377
Motordele Motordelar s. 411
Lejer Lager s. 435
Karburator Förgasare s. 467
El-dele/ Tænding Elektrisk/ Tänding s. 509
Blinklygter Baglygter Belysning Baklygter s. 611
Lyddæmper Avgassystem s. 651
Støddæmper Støtdämpare s. 681
Luft/ oliefilter Luft/ oljefilter s. 711
Kobling Koppling s. 769
Kabler Wire s. 803
Styr/greb Styre/ handtag s. 829
Spejle og diverse Speglar och diverse s. 867
Bøger/ værktøj Böcker/ verktyg s. 893

Tændrør til motorcykler
Tändstift till motorcyklar



Mærke/ model	Prod. årg.	NGK tændrør Varenr.	NGK nr.	DKK	SEK	Iridium Varenr.	Ref.nr.	DKK	SEK
Mærke/ modell	Prod. årg.	NGK tændrør Art.nr.	NGK nr.	DKK	SEK	Iridium Art.nr.	Ref.nr.	DKK	SEK
APRILIA									
Leonardo 125/150	95-08	210075	CR8E	79,-	99,-	215013	CR8EIX	163,-	204,-
RS 125 Extrema Replica	93-08	210041	B10EG	62,-	78,-				
RS 250	94-04	210048	BR9ECM	79,-	99,-				
RXV 450	05-10	210125	CR7EKB	97,-	121,-				
RXV 550	05-06	210120	CR8EB	75,-	94,-				
RXV 550	09-10	210166	CR8EKB	97,-	121,-				
Pegaso 600	88-93	210087	D8EA	29,-	36,-	215022	DR8EIX	163,-	204,-
Pegaso 650	92-00	210087	D8EA	29,-	36,-	215022	DR8EIX	163,-	204,-
Pegaso Strada	06	210073	CR7E	79,-	99,-	215014	CR7EIX	163,-	204,-
Moto 6,5	95-03	210087	D8EA	29,-	36,-	215022	DR8EIX	163,-	204,-
SL 750 Shiver	07-10	210125	CR7EKB	97,-	121,-				
Mana 850	07-10	210125	CR7EKB	97,-	121,-				
RSV 1000 Mile /R	98-10	210117	DCPR9-E	64,-	80,-	215023	DCPR9EIX	163,-	204,-
SL 1000 Falco	99-04	210117	DCPR9-E	64,-	80,-	215023	DCPR9EIX	163,-	204,-
RST 1000 Futura	01-04	210117	DCPR9-E	64,-	80,-	215023	DCPR9EIX	163,-	204,-
1000 Tuono	03-10	210117	DCPR9-E	64,-	80,-	215023	DCPR9EIX	163,-	204,-
ETV 1000 Caponord	02-09	210117	DCPR9-E	64,-	80,-	215023	DCPR9EIX	163,-	204,-
RSV 4	09-10	210156	CR9EB	79,-	99,-				
BENELLI									
900 Tornado RS/TRE	05-06	210070	C7E	62,-	78,-				
1130 TNT	05-06	210078	CR9E	79,-	99,-				
BUELL									
XB9 R/S Firebolt	04-05	210117	DCPR9-E	64,-	80,-	215023	DCPR9EIX	163,-	204,-
XB12 R/S Firebolt/Lightning	04-08	210117	DCPR9-E	64,-	80,-	215023	DCPR9EIX	163,-	204,-
BMW									
G 450 X	08-10	210168	CR9EKB	97,-	121,-				
R 50/5		210055	BP7ES	28,-	35,-	215000	BPR7EIX	163,-	204,-
R 60/5/6/7	>78	210055	BP7ES	28,-	35,-	215000	BPR7EIX	163,-	204,-
R 65	78>	210055	BP7ES	28,-	35,-	215000	BPR7EIX	163,-	204,-
F 650/ST/GS	93-08	210087	D8EA	29,-	36,-	215022	DR8EIX	163,-	204,-
F 650 GS	07-10	210116	DCPR8E	75,-	94,-				
G 650 X Country	07-10	210167	DR8EB	97,-	121,-				
G 650 X Moto	07-10	210167	DR8EB	97,-	121,-				
K 75 S/RT	85>	210086	D7EA	29,-	36,-				
R 75 /5/6/7		210054	BP6ES	26,-	33,-				
R 80 GS/RT/ST/R	82>	210054	BP6ES	26,-	33,-	215001	BPR6EIX	163,-	204,-
R 80 7N/7S	77-80	210054	BP6ES	26,-	33,-	215001	BPR6EIX	163,-	204,-
F 800 S/ST/GS	06-10	210116	DCPR8E	75,-	94,-				
R 850 R	95-00	210057	BCP7ET	57,-	71,-				
R 850 R	02-07	210169	BKR7EKC	79,-	99,-				
R 90/6 R 90/S	Alle	210054	BP6ES	26,-	33,-	215001	BPR6EIX	163,-	204,-
R 100		210055	BP7ES	28,-	35,-	215000	BPR7EIX	163,-	204,-
R 100 S/T	76-80	210055	BP7ES	28,-	35,-	215000	BPR7EIX	163,-	204,-
R 100 RS	>87	210055	BP7ES	28,-	35,-	215000	BPR7EIX	163,-	204,-
R 100 RS/GS	87>	210054	BP6ES	26,-	33,-	215001	BPR6EIX	163,-	204,-
R 100/7		210054	BP6ES	26,-	33,-	215001	BPR6EIX	163,-	204,-
R 100 RT/CS		210055	BP7ES	28,-	35,-	215000	BPR7EIX	163,-	204,-
R 100 R	94>	210054	BP6ES	26,-	33,-	215001	BPR6EIX	163,-	204,-
K 100 LT	83-91	210086	D7EA	29,-	36,-				
K 100 RS (4 valve)		210090	DR7EA	35,-	44,-				
K 100 RS	83>	210086	D7EA	29,-	36,-				
K1	89-93	210086	D7EA	29,-	36,-				
1000 RR	10-11	210178	LMAR9D-J	180,-	225,-				
K 1100 RS	92-00	210090	DR7EA	35,-	44,-				
K 1100 LT/RS	92-98	210090	DR7EA	35,-	44,-				
R 1100 RS/RT/GS	93-01	210057	BCP7ET	57,-	71,-	215003	BCPR7EIX	163,-	204,-
R 1150 GS/RT	01-04	210057	BCP7ET	57,-	71,-	215003	BCPR7EIX	163,-	204,-
K 1200/RS/GT/LT	97-04	210115	DCPR7E	57,-	71,-	215025	DCPR7EIX	163,-	204,-
R 1200 C	97-04	210063	BKR6EK	58,-	73,-				
K 1200 S	05-07	210169	BKR7EKC	79,-	99,-				
K 1200 GT	05-09	210158	KR9CI	182,-	228,-				
K 1200 R	05-09	210158	KR9CI	182,-	228,-				
K 1200 S/ST	05-09	210158	KR9CI	182,-	228,-				
R 1200 GS	08-09	210170	DCPR8EKC	97,-	121,-				
R 1200 RT	06-10	210158	KR9CI	182,-	228,-				
HP2 1200 Magamoto	08-10	210170	DCPR8EKC	97,-	121,-				
R 1300 GT/R/S	09-10	210158	KR9CI	182,-	228,-				
CAGIVA									
Raptor 650	00>	210075	CR8E	79,-	99,-	215013	CR8EIX	163,-	204,-
Grand Canyon 900	98>	210098	DPR8EA-9	33,-	41,-	215026	DPR8EIX-9	163,-	204,-
Navigator 1000	99>	210076	CR8EK	97,-	121,-	215013	CR8EIX	163,-	204,-
Raptor/V-Raptor 1000	00-07	210076	CR8EK	97,-	121,-	215013	CR8EIX	163,-	204,-

NGK tændrør verdens førende producent af tændrør

NGK er verdens førende producent af tændrør til motorcykelindustrien med fabrikker og kontorer over hele kloden. NGK begyndte i 1936 at fremstille kvalitetstændrør i Japan. Efterfølgende er NGK vokset til en kæmpe koncern med en moderne produktion. NGK investerer store summer i forskning og udvikling inden for motorsport. Det gælder både Formel 1 og motorcykelracing, hvor kun det bedste er godt nok og der ikke er plads til kompromisser. NGK's tændrør lever konstant op til dagens teknologi. Tændrørene har optimale præstationer og lang levetid, samtidig med at de forurener miljøet mindst muligt. Det gælder både i racing og i den daglige trafik.

NGK tændstift Verdens ledende tilverkere av tændstift

NGK är världens ledande tillverkare av tändstift till motorcykelindustri med fabriker över hela världen. NGK startade 1936 med att producera kvalitetständstift i Japan och har sen dess vuxit till en gigantisk koncern med "high tec"-produktion. NGK investerar stora summor på forskning och utveckling inom motorsport. Det gäller både Formel-1 och motorcykelracing där endast det bästa är gott nog och där man inte har utrymme för kompromisser. NGK's tändstift lever konstant upp till dagens krav med lång livslängd och max prestanda samtidigt som de är skonsamma mot miljön genom en så hög förbränning som möjligt. Det gäller både i race och i daglig trafik.

Tændrør til motorcykler
Tändstift till motorcyklar



Mærke/ model	Prod. årg.	NGK tændrør Varenr.	NGK nr.	DKK	SEK	Iridium Varenr.	Ref.nr.	DKK	SEK
Mærke/ modell	Prod. årg.	NGK tændrør Art.nr.	NGK nr.	DKK	SEK	Iridium Art.nr.	Ref.nr.	DKK	SEK
CZ									
CZ 180		210002	B6HS	28,-	35,-				
CZ 350	76-95	210002	B6HS	28,-	35,-				
DUCATI									
350 Indiana	86>	210055	BP7ES	28,-	35,-	215004	BR7HIX	163,-	204,-
350 Junior	92>	210014	BP7HS	28,-	35,-	215005	BPR7HIX	163,-	204,-
500 Pantah	80>	210003	B7HS	28,-	35,-	215004	BR7HIX	163,-	204,-
500 SL Pantah		210002	B6HS	28,-	35,-	215005	BPR7HIX	163,-	204,-
500 Sport Desmo	79-83	210002	B6HS	28,-	35,-	215006	BR6HIX	163,-	204,-
500 Sport Twin	78	210003	B7HS	28,-	35,-	215004	BR7HIX	163,-	204,-
600 Pantah SL/TL	81>	210014	BP7HS	28,-	35,-	215005	BPR7HIX	163,-	204,-
600 Monster	94-01	210116	DCPR8E	75,-	94,-	215024	DCPR8EIX	163,-	204,-
600 SS	94>	210099	DPR9EA-9	33,-	41,-	215023	DCPR9EIX	163,-	204,-
620 i.e./Dark	02>	210099	DPR9EA-9	33,-	41,-	215023	DCPR9EIX	163,-	204,-
620 Sport	03>	210116	DCPR8E	75,-	94,-	215024	DCPR8EIX	163,-	204,-
620 Multistrada	05-06	210116	DCPR8E	75,-	94,-	215024	DCPR8EIX	163,-	204,-
650 Indiana	87>	210014	BP7HS	28,-	35,-	215005	BPR7HIX	163,-	204,-
750 F1 Desmo		210014	BP7HS	28,-	35,-	215005	BPR7HIX	163,-	204,-
750 F1/LS	85>	210087	D8EA	29,-	36,-				
750 GT	74-76	210003	B7HS	28,-	35,-	215005	BPR7HIX	163,-	204,-
750 Indiana	87>	210014	BP7HS	28,-	35,-	215005	BPR7HIX	163,-	204,-
750 Monster	96-01	210116	DCPR8E	75,-	94,-	215024	DCPR8EIX	163,-	204,-
750 Paso	86	210098	DPR8EA-9	33,-	41,-	215026	DPR8EIX-9	163,-	204,-
750 Sport	88>	210098	DPR8EA-9	33,-	41,-	215026	DPR8EIX-9	163,-	204,-
750 SS	94>	210098	DPR8EA-9	33,-	41,-	215026	DPR8EIX-9	163,-	204,-
750 SS	72-83	210014	BP7HS	28,-	35,-				
800 Sport/Supersp./Monster	03-05	210116	DCPR8E	75,-	94,-	215024	DCPR8EIX	163,-	204,-
860 GT/GTS/S	75	210002	B6HS	28,-	35,-	215006	BR6HIX	163,-	204,-
848	08-10	210171	MAR10A-J	175,-	219,-				
900 Chiara	96	210098	DPR8EA-9	33,-	41,-	215026	DPR8EIX-9	163,-	204,-
900 Monster	97>	210116	DCPR8E	75,-	94,-	215024	DCPR8EIX	163,-	204,-
900 S/SS/GTS/SD/S2/HR	80>	210014	BP7HS	28,-	35,-	215005	BPR7HIX	163,-	204,-
900 Super Sport	88-90	210098	DPR8EA-9	33,-	41,-	215026	DPR8EIX-9	163,-	204,-
900 Superlight	92>	210098	DPR8EA-9	33,-	41,-	215026	DPR8EIX-9	163,-	204,-
900 IE	91>	210099	DPR9EA-9	33,-	41,-	215023	DCPR9EIX	163,-	204,-
Damah 900		210002	B6HS	28,-	35,-	215006	BR6HIX	163,-	204,-
900 SS	99-03	210098	DPR8EA-9	33,-	41,-	215026	DPR8EIX-9	163,-	204,-
Paso 906	88-90	210116	DCPR8E	75,-	94,-	215024	DCPR8EIX	163,-	204,-
900 Super Sport	91-92	210098	DPR8EA-9	33,-	41,-	215026	DPR8EIX-9	163,-	204,-
ST 2	97>	210098	DPR8EA-9	33,-	41,-	215026	DPR8EIX-9	163,-	204,-
Mille		210014	BP7HS	28,-	35,-	215005	BPR7HIX	163,-	204,-
1000 S2/HR	85>	210014	BP7HS	28,-	35,-	215005	BPR7HIX	163,-	204,-
1000 DS	03>	210116	DCPR8E	75,-	94,-	215024	DCPR8EIX	163,-	204,-
1000 Supersport/Monster	03-10	210116	DCPR8E	75,-	94,-	215024	DCPR8EIX	163,-	204,-
GT 1000 Sport Classic	08-10	210116	DCPR8E	75,-	94,-	215024	DCPR8EIX	163,-	204,-
Multistrada 1000/S	02-06	210098	DPR8EA-9	33,-	41,-	215026	DPR8EIX-9	163,-	204,-
1000 Paul Smart	06	210116	DCPR8E	75,-	94,-	215024	DCPR8EIX	163,-	204,-
1100/S	08-10	210116	DCPR8E	75,-	94,-	215024	DCPR8EIX	163,-	204,-
1100/S Monster	08-10	210116	DCPR8E	75,-	94,-	215024	DCPR8EIX	163,-	204,-
1098/S Street Fighter	09-10	210171	MAR10A-J	175,-	219,-				
1198/S	08-10	210171	MAR10A-J	175,-	219,-				
FYM									
125 Sport	05>	210097	DPR7EA-9	33,-	41,-				
125 Chopper	05>	210098	DPR8EA-9	33,-	41,-				
250 Custom	06>	210068	CR7HSA	35,-	44,-				
HARLEY DAVIDSON									
883 XLH Sportster/Custom 53	85-02	210097	DPR7EA-9	33,-	41,-	215027	DPR7EIX-9	163,-	204,-
XL 883 Sportster C/L/R	08-10	210115	DCPR7E	57,-	71,-				
1100 Evolution	86-87	210097	DPR7EA-9	33,-	41,-	215027	DPR7EIX-9	163,-	204,-
1100 Sportster	79-85	210020	BPR7HS	33,-	41,-				
1130 V-rod/Night-Rod	01-06	210117	DCPR9-E	64,-	80,-				
1200 Evolution/Sportster	88-04	210097	DPR7EA-9	33,-	41,-				
1200 Roadster/Custom	04-05	210097	DPR7EA-9	33,-	41,-				
1200 Shovelhead	75-80	210058	BPR6ES	33,-	41,-				
1200 XL Roadster/Custom	04-05	210097	DPR7EA-9	33,-	41,-				
1200 XL L/R/C Sportster	08-10	210115	DCPR7E	57,-	71,-				
1340 Shovelhead	78-79	210054	BP6ES	26,-	33,-				
1450 Twin Cam 88	99-04	210097	DPR7EA-9	33,-	41,-				
HONDA									
SJ 100 Scooter	96	210005	BR4HSA	28,-	35,-				
SJ 100 Scooter	97-98	210019	BPR6HSA	35,-	44,-	215006	BR6HIX	163,-	204,-
NSR 125 F	94	210051	BR10ES	35,-	44,-				
MTX 125	96	210043	BR7ES	35,-	44,-				

- Stikord Sökord s. 2-5
- Forhandlere Aterforsäljare s. 6-9
- Tøj/hjelme Klæder/hjälmar s. 11
- Dæk Däck s. 83
- Olie Olja s. 115
- Kæde/ tandhjul Kedjor/drev s. 145
- Bremser Broms s. 187
- Låse Lås s. 347
- Batteri Batterier s. 355
- Pakninger Packningar s. 377
- Motordele Motordelar s. 411
- Lejer Lager s. 435
- Karburator Förgasare s. 467
- El-dele/ Tænding Elektriskt/ Tändning s. 509
- Blinklygter Baglygter Belysning Baklykter s. 611
- Lyddæmper Avgassystem s. 651
- Støddæmper Støtdämpare s. 681
- Luft-/ oliefilter Luft-/ oljefilter s. 711
- Kobling Koppling s. 769
- Kabler Wire s. 803
- Styr/greb Styre/handtag s. 829
- Spejle og diverse Speglar och diverse s. 867
- Bøger/ værktøj Böcker/ verktyg s. 893

Tændrør til motorcykler
Tändstift till motorcyklar



Mærke/ model	Prod. årg.	NGK tændrør Varenr.	NGK nr.	DKK	SEK	Iridium Varenr.	Ref.nr.	DKK	SEK
Mærke/ modell	Prod. årg.	NGK tændrør Art.nr.	NGK nr.	DKK	SEK	Iridium Art.nr.	Ref.nr.	DKK	SEK
HONDA									
XL 125	79-86	210093	DR8ES-L	33,-	41,-	215022	DR8EIX	163,-	204,-
XR 125 L	03-09	210098	DPR8EA-9	33,-	41,-	215028	DPR9EIX-9	163,-	204,-
CBR 125 R	04-10	210078	CR9E	79,-	99,-	215015	CR9EIX	163,-	204,-
SES 125 Dylan	08-10	210154	CPR7EA-9	79,-	99,-				
ANF 125	03-09	210077	CR8EH-9	97,-	121,-				
CB 250 RS	03-09	210172	CPR6EA-9	75,-	94,-				
CMX 250 C Rebel	80-85	210093	DR8ES-L	33,-	41,-	215022	DR8EIX	163,-	204,-
NX 250	96-00	210067	CR6HSA	35,-	44,-	215016	CR6HIX	163,-	204,-
XL 250 S	94-95	210080	CR9EH-9	97,-	121,-	215017	CR9EHIX-9	163,-	204,-
XL 250 R	78-81	210093	DR8ES-L	33,-	41,-	215022	DR8EIX	163,-	204,-
XR 250	82-87	210103	DPR9Z	79,-	99,-				
CBF 250 X	95-04	210080	CR9EH-9	97,-	121,-	215017	CR9EHIX-9	163,-	204,-
CB 350 F	04-10	210146	CR8EA-9S	97,-	121,-				
CB 360	73-75	210087	D8EA	29,-	36,-				
XL 350	75-76	210023	B8ES	28,-	35,-				
CB 400 F	85>	210098	DPR8EA-9	33,-	41,-	215026	DPR8EIX-9	163,-	204,-
CB 400 T	75-78	210087	D8EA	29,-	36,-				
CB 400 N	78>	210091	DR8ES	33,-	41,-	215022	DR8EIX	163,-	204,-
CBR 400 (NC29)	79>	210091	DR8ES	33,-	41,-	215022	DR8EIX	163,-	204,-
CBX 400 F	90>	210077	CR8EH-9	97,-	121,-	215018	CR8EHIX-9	163,-	204,-
CM 400 C	82-84	210103	DPR9Z	79,-	99,-				
VF 400	80-84	210089	DR8ES	35,-	44,-	215022	DR8EIX	163,-	204,-
VFR 400 (NC30)	82-85	210098	DPR8EA-9	33,-	41,-	215026	DPR8EIX-9	163,-	204,-
XR 400	89>	210104	ER9EH	182,-	228,-				
CB 450	95-06	210102	DPR 8Z	79,-	99,-				
CB 450 S	73-75	210087	D8EA	29,-	36,-				
CB 450 NJ	86-88	210093	DR8ES-L	33,-	41,-	215022	DR8EIX	163,-	204,-
CB 500 K/K1	92-93	210089	DR8ES	35,-	44,-	215022	DR8EIX	163,-	204,-
CB 500 T	72-75	210087	D8EA	29,-	36,-				
CB 500 R	75-76	210023	B8ES	28,-	35,-				
CBF 500/A	95-04	210077	CR8EH-9	97,-	121,-	215018	CR8EHIX-9	163,-	204,-
CX 500	04-09	210077	CR8EH-9	97,-	121,-	215018	CR8EHIX-9	163,-	204,-
CX 500 C	79-83	210093	DR8ES-L	33,-	41,-	215022	DR8EIX	163,-	204,-
VF 500	80-83	210093	DR8ES-L	33,-	41,-	215022	DR8EIX	163,-	204,-
XL 500 S	84-86	210098	DPR8EA-9	33,-	41,-	215026	DPR8EIX-9	163,-	204,-
CB 550 F/K	86	210099	DPR9EA-9	33,-	41,-	215028	DPR9EIX-9	163,-	204,-
CBX 550 F/K	81-83	210093	DR8ES-L	33,-	41,-	215022	DR8EIX	163,-	204,-
CB 600 Hornet	82-86	210076	DR8ES-L	97,-	121,-	215022	DR8EIX	163,-	204,-
CBF 600 F/S	75-79	210086	D7EA	29,-	36,-				
CBR 600	82-84	210089	DR8ES	35,-	44,-	215022	DR8EIX	163,-	204,-
CBR 600 R	98-10	210080	CR9EH-9	97,-	121,-	215017	CR9EHIX-9	163,-	204,-
CBR 600 RR	00-10	210080	CR9EH-9	97,-	121,-	215017	CR9EHIX-9	163,-	204,-
CBR 600 RR	87-90	210099	DPR9EA-9	33,-	41,-	215028	DPR9EIX-9	163,-	204,-
VT 600 C/Shadow	91-00	210080	CR9EH-9	97,-	121,-	215017	CR9EHIX-9	163,-	204,-
XL 600 R	01-08	210108	IMR9C-9H	237,-	296,-				
XL 600 LM	03-07	210108	IMR9C-9H	237,-	296,-				
XL 600 Trans Alp	08-10	210147	IMR9C-9HES	232,-	290,-				
XL 600 Trans Alp	90-00	210098	DPR8EA-9	33,-	41,-	215026	DPR8EIX-9	163,-	204,-
XL 650 V Trans Alp	83-88	210098	DPR8EA-9	33,-	41,-	215026	DPR8EIX-9	163,-	204,-
XR 600	85>	210098	DPR8EA-9	33,-	41,-	215026	DPR8EIX-9	163,-	204,-
XR 650	87-90	210098	DPR8EA-9	33,-	41,-	215026	DPR8EIX-9	163,-	204,-
CB 650	87-90	210098	DPR8EA-9	33,-	41,-	215026	DPR8EIX-9	163,-	204,-
CX 650	91-04	210098	DPR8EA-9	33,-	41,-	215026	DPR8EIX-9	163,-	204,-
NTV 650 Revere	00-08	210098	DPR8EA-9	33,-	41,-	215026	DPR8EIX-9	163,-	204,-
NTV 650 Revere	00-08	210098	DPR8EA-9	33,-	41,-	215026	DPR8EIX-9	163,-	204,-
NT 650 Deauville	94-98	210099	DPR9EA-9	33,-	41,-	215028	DPR9EIX-9	163,-	204,-
NX 650 Dominator	98-05	210098	DPR8EA-9	33,-	41,-	215026	DPR8EIX-9	163,-	204,-
FX 650 Vigor	89-03	210098	DPR8EA-9	33,-	41,-	215026	DPR8EIX-9	163,-	204,-
FMX 650	99-00	210098	DPR8EA-9	33,-	41,-	215026	DPR8EIX-9	163,-	204,-
SLR 650	05-09	210098	DPR8EA-9	33,-	41,-	215026	DPR8EIX-9	163,-	204,-
NT 700 V/VA Deauville	97-99	210098	DPR8EA-9	33,-	41,-	215026	DPR8EIX-9	163,-	204,-
XL 700 VA Trans Alp	06-10	210148	CPR8EA-9	79,-	99,-				
DN-01 (700cc)	08->								
CB 750 K1/K6	71-78	210087	D8EA	29,-	36,-	215022	DR8EIX	163,-	204,-
CB 750 K7	77-79	210087	D8EA	29,-	36,-	215022	DR8EIX	163,-	204,-
CB 750 F1	76-79	210087	D8EA	29,-	36,-	215022	DR8EIX	163,-	204,-
CB 750 F2	77-80	210087	D8EA	29,-	36,-	215022	DR8EIX	163,-	204,-
CB 750 KZ	79-81	210093	DR8ES-L	33,-	41,-	215022	DR8EIX	163,-	204,-
CB 750 F	79-81	210093	DR8ES-L	33,-	41,-	215022	DR8EIX	163,-	204,-
CB 750 F2	80-83	210093	DR8ES-L	33,-	41,-	215022	DR8EIX	163,-	204,-
CB 750 C	82-84	210093	DR8ES-L	33,-	41,-	215022	DR8EIX	163,-	204,-
CB 750 C	81-84	210093	DR8ES-L	33,-	41,-	215022	DR8EIX	163,-	204,-

NGK tændrør verdens førende producent af tændrør

NGK er verdens førende producent af tændrør til motorcykelindustrien med fabrikker og kontorer over hele kloden. NGK begyndte i 1936 at fremstille kvalitetstændrør i Japan. Efterfølgende er NGK vokset til en kæmpe koncern med en moderne produktion. NGK investerer store summer i forskning og udvikling inden for motorsport. Det gælder både Formel 1 og motorcykelracing, hvor kun det bedste er godt nok og der ikke er plads til kompromisser. NGK's tændrør lever konstant op til dagens teknologi. Tændrørene har optimale præstationer og lang levetid, samtidig med at de forurener miljøet mindst muligt. Det gælder både i racing og i den daglige trafik.

NGK tændstift Verdens ledende tilverkkere af tændstift

NGK är världens ledande tillverkare av tändstift till motorcykelindustrin med fabrika örer hela världen. NGK startade 1936 med att producera kvalitetständstift i Japan och har sen dess vuxit till en gigantisk koncern med "high tec"-produktion. NGK investerar stora summor på forskning och utveckling inom motorsport. Det gäller både Formel-1 och motorcykelracing där endast det bästa är gott nog och där man inte har utrymme för kompromisser. NGK's tändstift lever konstant upp till dagens krav med lång livslängd och max prestanda samtidigt som de är skonsamma mot miljön genom en så hög förbränning som möjligt. Det gäller både i race och i daglig trafik.

Tændrør til motorcykler
Tändstift till motorcyklar



Mærke/ model	Prod. årg.	NGK tændrør Varenr.	NGK nr.	DKK	SEK	Iridium Varenr.	Ref.nr.	DKK	SEK
Mærke/ modell	Prod. årg.	NGK tændrør Art.nr.	NGK nr.	DKK	SEK	Iridium Art.nr.	Ref.nr.	DKK	SEK
HONDA									
CB 750 Seven Fifty	92-01	210098	DPR8EA-9	33,-	41,-	215026	DPR8EIX-9	163,-	204,-
CBX 750	84-88	210098	DPR8EA-9	33,-	41,-	215026	DPR8EIX-9	163,-	204,-
VF 750 C	82-85	210098	DPR8EA-9	33,-	41,-	215026	DPR8EIX-9	163,-	204,-
VF 750 C	86	210099	DPR9EA-9	33,-	41,-	215028	DPR9EIX-9	163,-	204,-
VF 750 Custom	96-99	210077	CR8EH-9	97,-	121,-	215018	CR8EHIX-9	163,-	204,-
VT 750 C /C2V/DC	97-08	210098	DPR8EA-9	33,-	41,-	215026	DPR8EIX-9	163,-	204,-
VF 750 S	82-84	210098	DPR8EA-9	33,-	41,-	215026	DPR8EIX-9	163,-	204,-
VF 750 F	83-85	210098	DPR8EA-9	33,-	41,-	215026	DPR8EIX-9	163,-	204,-
VFR 750	86-87	210098	DPR8EA-9	33,-	41,-	215026	DPR8EIX-9	163,-	204,-
VFR 750	88-89	210099	DPR9EA-9	33,-	41,-	215028	DPR9EIX-9	163,-	204,-
VFR 750	90-92	210077	CR9EH-9	97,-	121,-	215017	CR9EHIX-9	163,-	204,-
VFR 750 Pro Arm	93-97	210080	CR9EH-9	97,-	121,-	215017	CR9EHIX-9	163,-	204,-
VT 750 Shadow/Black Widow/C	04-10	210098	DPR8EA-9	33,-	41,-	215026	DPR8EIX-9	163,-	204,-
VFR 800	98-01	210080	CR9EH-8	97,-	121,-	215017	CR9EHIX-9	163,-	204,-
VFR 800	02-10	210107	IMR9B-9H	237,-	296,-				
RVF 750/RC 45	94-97	210083	CR9EHVX-9	150,-	188,-	215017	CR9EHIX-9	163,-	204,-
XRV 750 Africa Twin	83-03	210098	DPR8EA-9	33,-	41,-	215026	DPR8EIX-9	163,-	204,-
CB 900 F	79-83	210087	D8EA/DR8ES	29,-	36,-	215022	DR8EIX	163,-	204,-
CBR 900 RR Fireblade	92-99	210080	CR9EH-9	97,-	121,-	215017	CR9EHIX-9	163,-	204,-
CBR 900 RR Fireblade	00-03	210108	IMR9C-9H	237,-	296,-				
CB 900 Hornet	02-10	210077	CR8EH-9	97,-	121,-	215018	CR8EHIX-9	163,-	204,-
CBR 1000	87-89	210099	DPR9EA-9	33,-	41,-	215028	DPR9EIX-9	163,-	204,-
CBR 1000	90-99	210099	DPR9EA-9	33,-	41,-	215028	DPR9EIX-9	163,-	204,-
CBX 1000	79-82	210093	DR8ES-L	33,-	41,-	215022	DR8EIX	163,-	204,-
GL 1000	75-79	210093	DR8ES-L	33,-	41,-	215022	DR8EIX	163,-	204,-
VF 1000	82-84	210098	DPR8EA-9	33,-	41,-	215022	DR8EIX	163,-	204,-
VF 1000 R	84-87	210098	DPR8EA-9	33,-	41,-	215022	DR8EIX	163,-	204,-
VTR 1000 F	97-07	210101	DP9EVX-9	150,-	188,-				
VTR 1000 F/SP1/SP2	00-09	210149	IFR9H-11	259,-	324,-				
XL 1000 Varadero	99-05	210100	DPR8EVX-9	150,-	188,-	215026	DPR8EIX-9	163,-	204,-
XL 1000 V Varadero	03-10	210152	IJR8B9	281,-	351,-				
CB 1000 RA	08->	210147	IMR9C-9HES	232,-	290,-				
CBF 1000/A	06-10	210077	CR8EH-9	97,-	121,-	215018	CR8EHIX-9	163,-	204,-
XL 1000 V Varadero	03-07	210152	IJR8B9	281,-	351,-				
CBR 1000 RR Fireblade	04-07	210108	IMR9C-9H	237,-	296,-				
CBR 1000 RR ABS	08-10	210147	IMR9C-9HES	232,-	290,-				
CB 1100 F	82-85	210089	DR8ES	35,-	44,-	215022	DR8EIX	163,-	204,-
CBR 1100 XX Blackbird	97-09	210083	CR9EHVX-9	150,-	188,-				
CB 1100 SF/X Eleven	99-03	210082	CR8EHVA-9	150,-	188,-	215018	CR8EHIX-9	163,-	204,-
GL 1100	80-81	210093	DR8ES-L	33,-	41,-	215022	DR8EIX	163,-	204,-
GL 1100	82	210098	DPR8EA-9	33,-	41,-	215026	DPR8EIX-9	163,-	204,-
ST 1100 Pan European	91-02	210077	CR8EH-9	97,-	121,-	215018	CR8EHIX-9	163,-	204,-
VT 1100	95-96	210097	DPR7EA-9	33,-	41,-	215027	CPR7EIX-9	163,-	204,-
GL 1200	84-86	210098	DPR8EA-9	33,-	41,-	215026	DPR8EIX-9	163,-	204,-
ST 1300 Pan European	02-10	210074	CR7EH-9	97,-	121,-	215018	CR8EHIX-9	163,-	204,-
VTX 1300 S	03-09	210150	DCPR6E	86,-	108,-				
CB 1300	03-10	210098	DPR8EA-9	33,-	41,-	215028	DPR9EIX-9	163,-	204,-
GL 1500	91-03	210097	DPR7EA-9	33,-	41,-	215027	CPR7EIX-9	163,-	204,-
F6C Valkyrie	97>	210097	DPR7EA-9	33,-	41,-	215027	CPR7EIX-9	163,-	204,-
GL 1800	01-10	210061	BKR6E-11	40,-	50,-	215001	BPR6EIX	163,-	204,-
VTX 1800	01-09	210151	IFR6L-11	261,-	326,-				
HYOSUNG									
RX 125 D	04-11	210077	C8EH-9	97,-	121,-	215018	CR8EHIX-9	163,-	204,-
RX 125 SM	04-11	210077	C8EH-9	97,-	121,-	215018	CR8EHIX-9	163,-	204,-
RT 125 D	04-11	210077	C8EH-9	97,-	121,-	215018	CR8EHIX-9	163,-	204,-
GT 125 Naked	04-11	210075	CR8E	79,-	99,-	215013	CR8EIX	163,-	204,-
GT 250 Naked	04-11	210075	CR8E	79,-	99,-	215013	CR8EIX	163,-	204,-
GT 125 R	04-11	210075	CR8E	79,-	99,-	215013	CR8EIX	163,-	204,-
GT 250 R	04-11	210075	CR8E	79,-	99,-	215013	CR8EIX	163,-	204,-
GV 250	04-11	210075	CR8E	79,-	99,-	215013	CR8EIX	163,-	204,-
MS-3 250cc	06-10	210075	CR8E	79,-	99,-	215013	CR8EIX	163,-	204,-
GT 650 Naked	05-11	210075	CR8E	79,-	99,-	215013	CR8EIX	163,-	204,-
GT 650 S	05-07	210075	CR8E	79,-	99,-	215013	CR8EIX	163,-	204,-
GT 650 R	05-11	210075	CR8E	79,-	99,-	215013	CR8EIX	163,-	204,-
GV 650	05-11	210075	CR8E	79,-	99,-	215013	CR8EIX	163,-	204,-
ST 7 (700 cc)	10-11	210075	CR8E	79,-	99,-	215013	CR8EIX	163,-	204,-
JAWA									
350 cc	Alle	210004	B8HS	28,-	35,-	215007	BR8HIX	163,-	204,-
KAWASAKI									
KH 100		210023	B8ES	28,-	35,-	215008	BR8EIX	163,-	204,-
KH 125		210023	B8ES	28,-	35,-	215008	BR8EIX	163,-	204,-
BN 125 Eliminator	98-08	210075	CR8E	79,-	99,-	215013	CR8EIX	163,-	204,-
KLX 125	09-10	210068	CR7HSA	35,-	44,-				

- Stikord Sökord s. 2-5
- Forhandlere Aterforsäljare s. 6-9
- Tøj/hjelme Kläder/hjälmor s. 11
- Dæk Däck s. 83
- Olje Olja s. 115
- Kæde/ tandhjul Kedjor/drev s. 145
- Bremser Broms s. 187
- Låse Lås s. 347
- Batteri Batterier s. 355
- Pakninger Packningar s. 377
- Motordele Motordelar s. 411
- Lejer Lager s. 435
- Karburator Förgasare s. 467
- El-dele/ Tænding Elektriskt/ Tänding s. 509
- Blinklygter Baglygter Belysning Baklygter s. 611
- Lyddæmper Avgassystem s. 651
- Støddæmper Støtdåmpare s. 681
- Luft-/ oliefilter Luft-/ oljefilter s. 711
- Kobling Koppling s. 769
- Kabler Wire s. 803
- Styr/greb Styre/handtag s. 829
- Spejle og diverse Speglar och diverse s. 867
- Bøjer/værktøj Båcker/verktyg s. 893

Tændrør til motorcykler
Tändstift till motorcyklar



Mærke/ model	Prod. årg.	NGK tændrør Varenr.	NGK nr.	DKK	SEK	Iridium Varenr.	Ref.nr.	DKK	SEK
KAWASAKI									
KH 250	76-77	210005	B9HS	28,-	35,-				
KR1 250	88-92	210051	BR10ES	35,-	44,-	215009	BR10EIX	163,-	204,-
KLR 250	85-01	210099	DPR9EA-9	33,-	41,-	215028	DPR9EIX-9	163,-	204,-
ZZR 250	94>	210068	CR7HSA	35,-	44,-				
Ninja 250 R	07-10	210075	CR8E	79,-	99,-	215013	CR8EIX	163,-	204,-
KH 350	73-75	210004	B8HS	28,-	35,-				
Z 400	76-77	210022	B7ES	28,-	35,-				
Z 400	78-79	210022	B7ES	28,-	35,-				
Z 400 J	81-83	210087	D8EA	29,-	36,-	215022	DR8EIX	163,-	204,-
ZXR 400 R	90-03	210079	CR9EK	97,-	121,-	215015	CR9EIX	163,-	204,-
Z 450 LTD	84-89	210091	DR8ES	33,-	41,-	215022	DR8EIX	163,-	204,-
EN 500 Vulcan	94-00	210094	DR9EA	33,-	41,-	215029	DR9EIX	163,-	204,-
ER-5	97-04	210094	DR9EA	33,-	41,-	215029	DR9EIX	163,-	204,-
GPZ 500 S	87-04	210088	D9EA	29,-	36,-	215029	DR9EIX	163,-	204,-
KH 500	74-77	210005	B9HS	28,-	35,-				
KLE 500	91-09	210088	D9EA	29,-	36,-	215029	DR9EIX	163,-	204,-
Z 500 B2	81-82	210092	DR8EA	33,-	41,-	215022	DR8EIX	163,-	204,-
Z 550 Uni	83>	210087	D8EA	29,-	36,-	215022	DR8EIX	163,-	204,-
Z 550 GP	84>	210089	DR8ES	35,-	44,-	215022	DR8EIX	163,-	204,-
ZR 550 Zephyr	91-98	210094	DR9EA	33,-	41,-	215029	DR9EIX	163,-	204,-
GPZ 600 R	85-89	210091	DR8ES	33,-	41,-	215022	DR8EIX	163,-	204,-
GPX 600 R	88-97	210091	DR8ES	33,-	41,-	215022	DR8EIX	163,-	204,-
KLR 600	84-92	210098	DPR8EA-9	33,-	41,-	215026	DPR8EIX-9	163,-	204,-
ZL 600 Eliminator	95-96	210094	DR9EA	33,-	41,-	215029	DR9EIX	163,-	204,-
ER-6F A/B/N ABS	06-10					215019	CR9EIA-9	121,-	151,-
ZX 6 R/RR	95-08	210078	CR9E	79,-	99,-	215015	CR9EIX	163,-	204,-
ZZR 600	91-04	210078	CR9E	79,-	99,-	215015	CR9EIX	163,-	204,-
ZX 636	02-07	210078	CR9E	79,-	99,-	215015	CR9EIX	163,-	204,-
KLR 650	87-04	210098	DPR8EA-9	33,-	41,-	215026	DPR8EIX-9	163,-	204,-
KLX 650	92-03	210098	DPR8EA-9	33,-	41,-	215026	DPR8EIX-9	163,-	204,-
KLE 650 Versys ABS	06-10					215019	CR9EIA-9	121,-	151,-
Z 650	77-79	210022	B7ES	28,-	35,-				
Z 650	80-83	210023	B8ES	28,-	35,-	215008	BR8EIX	163,-	204,-
Z 650 SR	79-83	210023	B8ES	28,-	35,-	215008	BR8EIX	163,-	204,-
W 650	99-06	210075	CR8E	79,-	99,-	215013	CR8EIX	163,-	204,-
GPZ 750 Uni Trak	83-85	210044	BR8ES	33,-	41,-	215008	BR8EIX	163,-	204,-
GPX 750 R	87-89	210089	DR8ES	35,-	44,-	215022	DR8EIX	163,-	204,-
KH 750	72-75	210005	B9HS	28,-	35,-				
VN 750 Vulcan	94>	210097	DPR7EA-9	33,-	41,-	215027	CPR7EIX-9	163,-	204,-
Z 750 2 cyl.	76-78	210023	B8ES	28,-	35,-	215008	BR8EIX	163,-	204,-
Z 750/E	81-85	210044	BR8ES	33,-	41,-	215008	BR8EIX	163,-	204,-
Z 750 Turbo	84-85	210049	BR9EV	150,-	188,-	215010	BR9EIX	163,-	204,-
ZR 750 Zephyr	91-00	210089	DR8ES	35,-	44,-	215022	DR8EIX	163,-	204,-
ZR-7 S	99-04	210094	DR9EA	33,-	41,-	215029	DR9EIX	163,-	204,-
ZX 7 R/RR	96-03	210078	CR9E	79,-	99,-	215015	CR9EIX	163,-	204,-
ZR 750 J1 / Z 750	04-10	210079	CR9EK	97,-	121,-	215015	CR9EIX	163,-	204,-
ZXR 750	89-91	210078	CR9E	79,-	99,-	215015	CR9EIX	163,-	204,-
ZXR 750	92-01	210078	CR9E	79,-	99,-	215015	CR9EIX	163,-	204,-
VN 800 Vulcan/Classic	95-03	210073	CR7E	79,-	99,-	215015	CR9EIX	163,-	204,-
VV 800 Vulcan/Classic	95-06	210075	CR8E	79,-	99,-	215015	CR9EIX	163,-	204,-
VN 800 Drifter	99-03	210073	CR7E	79,-	99,-	215015	CR9EIX	163,-	204,-
VN 900 Custom	06-09	210154	CRP7EA	79,-	99,-				
Z 900	73-76	210023	B8ES	28,-	35,-	215008	BR8EIX	163,-	204,-
GPZ 900 R	84-90	210091	DR8ES	33,-	41,-	215022	DR8EIX	163,-	204,-
GPZ 900 R	91-96	210088	D9EA	29,-	36,-	215029	DR9EIX	163,-	204,-
ZX 9 R	94-04	210079	CR9EK	97,-	121,-	215015	CR9EIX	163,-	204,-
GPZ 1000 RX	86-87	210088	D9EA	29,-	36,-	215029	DR9EIX	163,-	204,-
Z 1000	77-79	210023	B8ES	28,-	35,-	215008	BR8EIX	163,-	204,-
Z 1000 Z1R	79	210023	B8ES	28,-	35,-	215008	BR8EIX	163,-	204,-
Z 1000 MKII	80-81	210023	B8ES	28,-	35,-	215008	BR8EIX	163,-	204,-
Z 1000 ST	79-80	210023	B8ES	28,-	35,-	215008	BR8EIX	163,-	204,-
Z 1000 J	81-84	210044	BR8ES	33,-	41,-	215008	BR8EIX	163,-	204,-
Z 1000 R	81-83	210044	BR8ES	33,-	41,-	215008	BR8EIX	163,-	204,-
ZX 10	88-90	210078	CR9E	79,-	99,-	215015	CR9EIX	163,-	204,-
ZX 10 R	04-10					215019	CR9EIA-9	121,-	151,-
Z 1000 (ZR1000A1/B/C)	03-10	210079	CR9EK	97,-	121,-	215019	CR9EIA-9	121,-	151,-
1000 GTR	86-03	210089	DR8ES	35,-	44,-	215022	DR8EIX	163,-	204,-
KLV 1000	04-07	210076	CR8EK	97,-	121,-	215013	CR8EIX	163,-	204,-
GPZ 1100	81-82	210044	BR8ES	33,-	41,-	215008	BR8EIX	163,-	204,-
GPZ 1100 Uni Trak	83-85	210044	BR8ES	33,-	41,-	215008	BR8EIX	163,-	204,-
GPZ 1100	95-98	210079	CR9EK	97,-	121,-	215008	BR8EIX	163,-	204,-
Z 1100 ST	81-82	210044	BR8ES	33,-	41,-	215008	BR8EIX	163,-	204,-
ZZR 1100	90-01	210078	CR9E	79,-	99,-	215015	CR9EIX	163,-	204,-
ZRX 1100	97-00	210079	CR9EK	97,-	121,-	215015	CR9EIX	163,-	204,-

NGK tændrør verdens førende producent af tændrør

NGK er verdens førende producent af tændrør til motorcykelindustrien med fabrikker og kontorer over hele kloden. NGK begyndte i 1936 at fremstille kvalitetstændrør i Japan. Efterfølgende er NGK vokset til en kæmpe koncern med en moderne produktion. NGK investerer store summer i forskning og udvikling inden for motorsport. Det gælder både Formel 1 og motorcykelracing, hvor kun det bedste er godt nok og der ikke er plads til kompromisser. NGK's tændrør lever konstant op til dagens teknologi. Tændrørene har optimale præstationer og lang levetid, samtidig med at de forurener miljøet mindst muligt. Det gælder både i racing og i den daglige trafik.

NGK tændstift Verdens ledende tilverkere av tændstift

NGK är världens ledande tillverkare av tändstift till motorcykelindustri med fabriker över hela världen. NGK startade 1936 med att producera kvalitetständstift i Japan och har sen dess vuxit till en gigantisk koncern med "high tec"-produktion. NGK investerar stora summer på forskning och utveckling inom motorsport. Det gäller både Formel-1 och motorcykelracing där endast det bästa är gott nog och där man inte har utrymme för kompromisser. NGK's tändstift lever konstant upp till dagens krav med lång livslängd och max prestanda samtidigt som de är skonsamma mot miljön genom en så hög förbränning som möjligt. Det gäller både i race och i daglig trafik.

Tændrør til motorcykler
Tändstift till motorcyklar



Mærke/ model	Prod. årg.	NGK tændrør Varenr.	NGK nr.	DKK	SEK	Iridium Varenr.	Ref.nr.	DKK	SEK
Mærke/ modell	Prod. årg.	NGK tændrør Art.nr.	NGK nr.	DKK	SEK	Iridium Art.nr.	Ref.nr.	DKK	SEK
KAWASAKI									
ZRX 1200	01-07	210079	CR9EK	97,-	121,-	215015	CR9EIX	163,-	204,-
ZZR 1200	02-05	210078	CR9E	79,-	99,-	215015	CR9EIX	163,-	204,-
ZX 12 R	00-07	210081	CR9EKPA	208,-	260,-				
Z 1300	79	210023	B8ES	28,-	35,-	215008	BR8EIX	163,-	204,-
Z 1300	80>	210058	BPR6ES	33,-	41,-	215008	BR8EIX	163,-	204,-
ZZ-R 1400	06-08					215019	CR9EIA-9	121,-	151,-
GTR 1400 ABS	07-10					215019	CR9EIA-9	121,-	151,-
VN 1500 A/B	93-98	210097	DPR7EA-9	33,-	41,-				
VN 1500 Classic	98-00	210095	DPR5EA-9	35,-	44,-				
VN 1500 Meanstreak	02-04	210096	DPR6EA-9	35,-	44,-				
VN 1600 Classic/Mean Streak	03-09	210096	DPR6EA-9	35,-	44,-				
VN 1700 Voyager	09-10	210173	ILZKAR7B11	275,-	344,-				
VN 2000	04-09	210155	IFR6F-11	215,-	269,-				
KTM									
125 EXE	99>	210010	BR8HS	33,-	41,-	215007	BR8HIX	163,-	204,-
200 EXC/MXC	98-08	210044	BR8EG	33,-	41,-				
250 Enduro	84>	210041	B10EG	62,-	78,-				
LC 4 350	93>	210087	D8EA	29,-	36,-	215022	DR8EIX	163,-	204,-
LC 4 400	93-02	210087	D8EA	29,-	36,-	215022	DR8EIX	163,-	204,-
450 EXC	03>	210116	DCPR8E	75,-	94,-	215024	DCPR8EIX	163,-	204,-
450 SMR	05	210116	DCPR8E	75,-	94,-	215024	DCPR8EIX	163,-	204,-
500 SX	93>	210030	B10ES	29,-	36,-	215010	BR9EIX	163,-	204,-
520 SX Racing	02>	210116	DCPR8E	75,-	94,-	215024	DCPR8EIX	163,-	204,-
600 Enduro/LC4	84-96	210087	D8EA	29,-	36,-	215022	DR8EIX	163,-	204,-
620 Duke	94>	210087	D8EA	29,-	36,-	215022	DR8EIX	163,-	204,-
620 EGS/SC/LC4SX	94-01	210087	D8EA	29,-	36,-	215022	DR8EIX	163,-	204,-
640 Duke 2	00-02	210098	DPR8EA-9	33,-	41,-	215026	DPR8EIX-9	163,-	204,-
640 Duke 2/LC4	02-05	210116	DCPR8E	75,-	94,-	215024	DCPR8EIX	163,-	204,-
660 Rallye/LC4	02-05	210094	DR9EA	33,-	41,-	215029	DR9EIX	163,-	204,-
950 Adventure/LC8 Rally	03-09	210076	CR8EK	97,-	121,-	215013	CR8EIX	163,-	204,-
990 Duke/Super Duke	04-09	210116	DCPR8E	75,-	94,-	215024	DCPR8EIX	163,-	204,-
950 Super Enduro	03-08	210076	CR8EK	97,-	121,-	215013	CR8EIX	163,-	204,-
950 Super Moto	03-09	210076	CR8EK	97,-	121,-	215013	CR8EIX	163,-	204,-
KYMCO									
People S 250									
Xciting 500 i									
Super 8 125									
LAVERDA									
500 Alpino/Mont Juich		210088	D9EA	29,-	36,-	215029	DR9EIX	163,-	204,-
OR 600 Atlas		210087	D8EA	29,-	36,-	215022	DR8EIX	163,-	204,-
650 Strike/Legend	96>	210098	DPR8EA-9	33,-	41,-	215023	DCPR9EIX	163,-	204,-
650 Ghost/Sport	95	210099	DPR9EA-9	33,-	41,-	215023	DCPR9EIX	163,-	204,-
668	96>	210099	DPR9EA-9	33,-	41,-	215023	DCPR9EIX	163,-	204,-
750 GS/GT/S/SFC/SF-2D	72-77	210056	BP8ES	29,-	36,-				
770 GTL		210055	BP7ES	28,-	35,-	215000	BPR7EIX	163,-	204,-
SF/SF Competizione/SS		210040	B10EV	105,-	131,-				
SF2-10/SF3		210023	B8ES	28,-	35,-	215008	BR8EIX	163,-	204,-
1000 RGS	82-87	210023	B8ES	28,-	35,-	215008	BR8EIX	163,-	204,-
1000/Jamara/Jota/SC/CE/CL	80-84	210023	B8ES	28,-	35,-	215008	BR8EIX	163,-	204,-
1200/Mirage/TS	78-82	210023	B8ES	28,-	35,-	215008	BR8EIX	163,-	204,-
MOTO GUZZI									
V 35 Nevada	92	210023	B8ES	28,-	35,-	215008	BR8EIX	163,-	204,-
Monza 500	81-87	210056	BP8ES	29,-	36,-				
V 50/Custom/II	77-81	210055	BP7ES	28,-	35,-	215000	BPR7EIX	163,-	204,-
V 50 II	81-87	210056	BP8ES	29,-	36,-	215000	BPR7EIX	163,-	204,-
V 50 Monza II	84-87	210069	CH8HSA	35,-	44,-	215020	CR8HIX	163,-	204,-
V 65/SP/TT/Florida	>86	210056	BP8ES	29,-	36,-				
V 65	87>	210175	BCPR6ES	45,-	56,-				
V 65 Florida	92>	210056	B8ES	29,-	36,-	215008	BR8EIX	163,-	204,-
V 65 Lario	>86	210069	CR8HSA	35,-	44,-				
V 65 NTX	>89	210056	BP8ES	29,-	36,-	215020	CR8HIX	163,-	204,-
V 65 NTX	90-92	210023	B8ES	28,-	35,-				
750 S	>74	210054	BP6ES	26,-	33,-	215001	BPR6EIX	163,-	204,-
750 SP/Targa	92>	210023	B8ES	28,-	35,-	215008	BR8EIX	163,-	204,-
V 75 Nevada	92-03	210023	B8ES	28,-	35,-	215008	BR8EIX	163,-	204,-
V 750 NTX/Polizia NT	92>	210023	B8ES	28,-	35,-	215008	BR8EIX	163,-	204,-
Nevada Classic 750	04-10	210044	BR8ES	33,-	41,-	215008	BR8EIX	163,-	204,-
Nevada 750 ie	04-10	210044	BR8ES	33,-	41,-	215008	BR8EIX	163,-	204,-
Breva V750	03-10	210044	BR8ES	33,-	41,-	215008	BR8EIX	163,-	204,-
850 California	76-81	210054	BP6ES	26,-	33,-	215001	BPR6EIX	163,-	204,-
850 Le Mans II	78-81	210054	BP6ES	26,-	33,-	215001	BPR6EIX	163,-	204,-
850 T4/T5/TS5	80-87	210054	BP6ES	26,-	33,-	215001	BPR6EIX	163,-	204,-

- Stikord Sökord s. 2-5
- Forhandlere Aterforsäljare s. 6-9
- Tøj/hjelme Klæder/hjälmar s. 11
- Dæk Däck s. 83
- Oljeolja s. 115
- Kæde/tandhjul Kedjor/drev s. 145
- Bremser Broms s. 187
- Låse Lås s. 347
- Batteri Batterier s. 355
- Pakninger Packningar s. 377
- Motordele Motordelar s. 411
- Lejer Lager s. 435
- Karburator Förgasare s. 467
- El-dele/Tænding Elektriskt/Tänding s. 509
- Blinklygter Baglygter Belysning Baklygter s. 611
- Lyddæmper Avgassystem s. 651
- Støddæmper Støtdämpare s. 681
- Luft/oliefilter Luft/oljefilter s. 711
- Kobling Koppling s. 769
- Kabler Wire s. 803
- Styr/greb Styre/handtag s. 829
- Spejle og diverse Speglar och diverse s. 867
- Bøger/værktøj Böcker/verktyg s. 893

Tændrør til motorcykler
Tändstift till motorcyklar



Mærke/ model	Prod. årg.	NGK tændrør Varenr.	NGK nr.	DKK	SEK	Iridium Varenr.	Ref.nr.	DKK	SEK
Mærke/ modell	Prod. årg.	NGK tændrør Art.nr.	NGK nr.	DKK	SEK	Iridium Art.nr.	Ref.nr.	DKK	SEK
MOTO GUZZI									
Griso 850	07-09	210058	BPR6ES	33,-	41,-	215011	BR6EIX	163,-	204,-
Breva V850	06-09	210058	BPR6ES	33,-	41,-	215011	BR6EIX	163,-	204,-
Norge 850	07-09	210058	BPR6ES	33,-	41,-	215011	BR6EIX	163,-	204,-
1000/GT		210054	BP6ES	26,-	33,-	215001	BPR6EIX	163,-	204,-
1000 Le Mans	90>	210055	BP7ES	28,-	35,-	215000	BPR7EIX	163,-	204,-
1000 Le Mans IV	85-89	210056	BP8ES	29,-	36,-				
1000 S	89>	210055	BP7ES	28,-	35,-	215000	BPR7EIX	163,-	204,-
1000 SP III	88-92	210054	BP6RS	26,-	33,-	215001	BPR6EIX	163,-	204,-
California I.E. (Injection)	91>	210055	BP7ES	28,-	35,-	215000	BPR7EIX	163,-	204,-
California III	88>	210054	BP6ES	26,-	33,-	215001	BPR6EIX	163,-	204,-
Daytona 1000	92>	210088	D9EA	29,-	36,-	215029	DR9EIX	163,-	204,-
Quota 1000	92>	210055	BP7ES	28,-	35,-	215000	BPR7EIX	163,-	204,-
T5 Polizia (1000 cc)	92>	210054	BP6ES	26,-	33,-	215001	BPR6EIX	163,-	204,-
V 10 Centauro	96>	210094	DR9EA	33,-	41,-	215029	DR9EIX	163,-	204,-
California 1100 KC/KD	94>	210058	BPR6ES	33,-	41,-	215011	BR6EIX	163,-	204,-
Sport 1100i	96>	210058	BPR6ES	33,-	41,-	215011	BR6EIX	163,-	204,-
Sport	95>	210058	BPR6ES	33,-	41,-	215011	BR6EIX	163,-	204,-
1100 Sport (KF) Injection	96>	210058	BPR6ES	33,-	41,-	215011	BR6EIX	163,-	204,-
V11 (alle)	99>	210058	BPR6ES	33,-	41,-	215011	BR6EIX	163,-	204,-
Griso 1100	05-06	210058	BPR6ES	33,-	41,-	215011	BR6EIX	163,-	204,-
Griso 1100	06-10	210166	CR8EKB	97,-	121,-				
California 1100	02-10	210058	BPR6ES	33,-	41,-	215011	BR6EIX	163,-	204,-
Breva V1100	03-10	210058	BPR6ES	33,-	41,-	215011	BR6EIX	163,-	204,-
Brava V 1200 S	07-08	210058	BPR6ES	33,-	41,-	215011	BR6EIX	163,-	204,-
Sport 1200/Norge	06-10	210058	BPR6ES	33,-	41,-	215011	BR6EIX	163,-	204,-
Stelvio 1200	08-10	210166	CR8EKB	97,-	121,-				
MOTO MORINI									
350 Excalibur	92>	210055	BP7ES	28,-	35,-	215000	BPR7EIX	163,-	204,-
400 Dart	91>	210056	BP8ES	29,-	36,-				
501 Excalibur	91>	210056	BP8ES	29,-	36,-				
501 Excalibur	92>	210055	BP7ES	28,-	35,-	215000	BPR7EIX	163,-	204,-
MV AGUSTA									
F45	99-09	210156	CR9EB	79,-	36,-	215015	CR9EIX	163,-	204,-
Brutale S/Oro	99-09	210156	CR9EB	79,-	36,-	215015	CR9EIX	163,-	204,-
F45-1+1	99-09	210156	CR9EB	79,-	36,-	215015	CR9EIX	163,-	204,-
F4SPR/Senna	99-09	210156	CR9EB	79,-	36,-	215015	CR9EIX	163,-	204,-
MZ									
125 Saxon	91>	210004	B8HS	28,-	35,-	215007	BR8HIX	163,-	204,-
150 ETZ	84-90	210004	B8HS	28,-	35,-	215007	BR8HIX	163,-	204,-
251 TS	75-85	210004	B8HS	28,-	35,-	215007	BR8HIX	163,-	204,-
302 ETZ/Saxon	91-97	210004	B8HS	28,-	35,-	215007	BR8HIX	163,-	204,-
660 Skorpion	94-05	210098	DPR8EA-9	33,-	41,-	215028	DPR9EIX-9	163,-	204,-
SUZUKI									
DS 80	Alle	210022	B7ES	28,-	35,-				
LT 50, 4 hjulet	Alle	210016	BPR4HS	35,-	44,-				
AP 100 Adress		210013	BP6HS	26,-	33,-				
AN 125	95-00	210075	CR8E	79,-	99,-	215013	CR8EIX	163,-	204,-
GN 125	94-00	210093	DR8ES-L	33,-	41,-	215022	DR8EIX	163,-	204,-
RG 125	94>	210048	BR9ECM	79,-	99,-	215010	BR9EIX	163,-	204,-
RV 125 Van Van	03-10	210075	CR8E	79,-	99,-	215013	CR8EIX	163,-	204,-
TS 125	80>	210023	B8ES	28,-	35,-	215008	BR8EIX	163,-	204,-
DR-Z 125	02-10	210092	DR8EA	33,-	41,-	215022	DR8EIX	163,-	204,-
FL 125	07-10	210064	C6HSA	29,-	36,-				
TS 185	79>	210055	BP7ES	28,-	35,-	215000	BPR7EIX	163,-	204,-
DR 250	90-92	210093	DR8ES-L	33,-	41,-	215022	DR8EIX	163,-	204,-
GN 250	90-00	210093	DR8ES-L	33,-	41,-	215022	DR8EIX	163,-	204,-
GT 250	73-79	210023	B8ES	28,-	35,-	215008	BR8EIX	163,-	204,-
GSX 250	80-84	210089	DR8ES	35,-	44,-	215022	DR8EIX	163,-	204,-
GSX R 250	90-91	210068	CR7HSA	35,-	44,-				
GZ 250 Marauder	99-09	210092	DR8EA	33,-	41,-	215022	DR8EIX	163,-	204,-
RG 250	83	210047	BR9ES	33,-	41,-	215010	BR9EIX	163,-	204,-
RG 250	84-88	210047	BR9ES	33,-	41,-	215010	BR9EIX	163,-	204,-
TS 250	84-88	210047	BR9ES	33,-	41,-	215010	BR9EIX	163,-	204,-
TU 250	97-00	210093	DR8ES-L	33,-	41,-	215022	DR8EIX	163,-	204,-
AN 250 Burgman	99-06	210076	CR8EK	97,-	121,-	215013	CR8EIX	163,-	204,-
DR 350	90-94	210099	DPR9EA-9	33,-	41,-	215028	DPR9EIX-9	163,-	204,-
DR 350	95-98	210079	CR9EK	97,-	121,-	215015	CR9EIX	163,-	204,-
GT 380	73-78	210022	B7ES	28,-	35,-				
GN 400	80-82	210093	DR8ES-L	33,-	41,-	215022	DR8EIX	163,-	204,-
GSX R 400 R	91-92	210069	CR8HSA	35,-	44,-	215020	CR8HIX	163,-	204,-
GSX R 400 J	93-95	210079	CR9EK	97,-	121,-	215015	CR9EIX	163,-	204,-
GSF 400 Bandit	91-95	210076	CR8EK	97,-	121,-	215013	CR8EIX	163,-	204,-

NGK tændrør verdens førende producent af tændrør

NGK er verdens førende producent af tændrør til motorcykelindustrien med fabrikker og kontorer over hele kloden. NGK begyndte i 1936 at fremstille kvalitetstændrør i Japan. Efterfølgende er NGK vokset til en kæmpe koncern med en moderne produktion. NGK investerer store summer i forskning og udvikling inden for motorsport. Det gælder både Formel 1 og motorcykelracing, hvor kun det bedste er godt nok og der ikke er plads til kompromisser. NGK's tændrør lever konstant op til dagens teknologi. Tændrørene har optimale præstationer og lang levetid, samtidig med at de foruren miljøet mindst muligt. Det gælder både i racing og i den daglige trafik.

NGK tændstift Verdens ledende tilverkkere av tændstift

NGK är världens ledande tillverkare av tändstift till motorcykelindustri med fabriker över hela världen. NGK startade 1936 med att producera kvalitetständstift i Japan och har sen dess vuxit till en gigantisk koncern med "high tec"-produktion. NGK investerar stora summer på forskning och utveckling inom motorsport. Det gäller både Formel-1 och motorcykelracing där endast det bästa är gott nog och där man inte har utrymme för kompromisser. NGK's tändstift lever konstant upp till dagens krav med lång livslängd och max prestanda samtidigt som de är skonsamma mot miljön genom en så hög förbränning som möjligt. Det gäller både i race och i daglig trafik.

Tændrør til motorcykler
Tändstift till motorcyklar



Mærke/ model	Prod. årg.	NGK tændrør Varenr.	NGK nr.	DKK	SEK	Iridium Varenr.	Ref.nr.	DKK	SEK
Mærke/ modell	Prod. årg.	NGK tændrør Art.nr.	NGK nr.	DKK	SEK	Iridium Art.nr.	Ref.nr.	DKK	SEK
SUZUKI									
GS 400	77-79	210023	B8ES	28,-	35,-	215008	BR8EIX	163,-	204,-
GSX 400	80-87	210093	DR8ES-L	33,-	41,-	215022	DR8EIX	163,-	204,-
DR-Z 400 E/S/SM	99-10	210075	CR8E	79,-	99,-	215013	CR8EIX	163,-	204,-
AN 400 Burgman	99-10	210073	CR7E	79,-	99,-	215014	CR7EIX	163,-	204,-
GS 425	79	210023	B8ES	28,-	35,-				
GS 450	80-87	210023	B8ES	28,-	35,-	215008	BR8EIX	163,-	204,-
DR 500	81>	210093	DR8ES-L	33,-	41,-	215022	DR8EIX	163,-	204,-
GS 500 E	89-09	210098	DPR8EA-9	33,-	41,-	215026	DPR8EIX-9	163,-	204,-
GS 500 F	04-09	210098	DPR8EA-9	33,-	41,-	215026	DPR8EIX-9	163,-	204,-
RG 500 Gamma	86-88	210027	B9ES	28,-	35,-	215010	BR9EIX	163,-	204,-
GT 550	73-77	210023	B8ES	28,-	35,-	215008	BR8EIX	163,-	204,-
GS 550	77-79	210023	B8ES	28,-	35,-	215008	BR8EIX	163,-	204,-
GS 550 E	80-83	210023	B8ES	28,-	35,-	215008	BR8EIX	163,-	204,-
GS 550 C	79-82	210023	B8ES	28,-	35,-				
GSX 550 ES	83-88	210091	DR8ES	33,-	41,-				
GSF 600 Bandit	95-04	210079	CR9EK	97,-	121,-	215015	CR9EIX	163,-	204,-
GSX 600 F	88-95	210091	DR8ES	33,-	41,-	215022	DR8EIX	163,-	204,-
GSX 600 F	96-06	210079	CR9EK	97,-	121,-	215015	CR9EIX	163,-	204,-
GSX R 600	97-09	210078	CR9E	79,-	99,-	215015	CR9EIX	163,-	204,-
DR 600	85-88	210099	DPR9EA-9	33,-	41,-	215028	DPR9EIX-9	163,-	204,-
RF 600	93-97	210078	CR9E	79,-	99,-	215015	CR9EIX	163,-	204,-
VS 600 GLS	95-98	210098	DPR8EA-9	33,-	41,-	215026	DPR8EIX-9	163,-	204,-
GSR 600	06-10	210078	CR9E	79,-	99,-	215015	CR9EIX	163,-	204,-
DL 650 V-Strom	04-10	210075	CR8E	79,-	99,-	215013	CR8EIX	163,-	204,-
DR 650	89-97	210099	DPR9EA-9	33,-	41,-	215028	DPR9EIX-9	163,-	204,-
DR 650 SE	95-97	210078	CR9E	79,-	99,-	215015	CR9EIX	163,-	204,-
DR 650 SE	95-99	210177	CR10E	79,-	99,-				
GS 650/E	81-84	210093	DR8ES-L	33,-	41,-	215022	DR8EIX	163,-	204,-
LS 650	89-99	210098	DPR8EA-9	33,-	41,-	215026	DPR8EIX-9	163,-	204,-
SV 650/S ABS	99-10	210075	CR8E	79,-	99,-	215013	CR8EIX	163,-	204,-
SVF 650 Gladius	08-10	210075	CR8E	79,-	99,-	215013	CR8EIX	163,-	204,-
XF 650 Freewind	97-05	210084	CR10EK	97,-	121,-				
AN 650 Burgman	03-10	210075	CR8E	79,-	99,-	215013	CR8EIX	163,-	204,-
GSF 650 Bandit ABS	05-10	210078	CR9E	79,-	99,-				
GSX 650 F	08-10	210075	CR8E	79,-	99,-	215013	CR8EIX	163,-	204,-
VS 700	87>	210098	DPR8EA-9	33,-	41,-	215026	DPR8EIX-9	163,-	204,-
DR 750	88-95	210099	DPR9EA-9	33,-	41,-	215028	DPR9EIX-9	163,-	204,-
GS 750	77-80	210023	B8ES	28,-	35,-	215008	BR8EIX	163,-	204,-
GSX 750	80-82	210093	DR8ES-L	33,-	41,-	215022	DR8EIX	163,-	204,-
GSX 750 ES	83-86	210093	DR8ES-L	33,-	41,-	215022	DR8EIX	163,-	204,-
GSX 750 Katana	82-86	210087	D8EA	29,-	36,-	215022	DR8EIX	163,-	204,-
GSX 750 F	89-97	210111	JR9C	79,-	99,-	215029	DR9EIX	163,-	204,-
GSX 750 F	98-09	210079	CR9EK	97,-	121,-	215015	CR9EIX	163,-	204,-
GSX 750	99-03	210079	CR9EK	97,-	121,-	215015	CR9EIX	163,-	204,-
GSX R 750	85-87	210111	JR9C	79,-	99,-	215029	DR9EIX	163,-	204,-
GSX R 750	88-92	210084	CR10EK	97,-	121,-	215021	CR10EIX	163,-	204,-
GSX R 750	93-94	210079	CR9EK	97,-	121,-	215015	CR9EIX	163,-	204,-
GSX R 750	95-09	210078	CR9E	79,-	99,-	215015	CR9EIX	163,-	204,-
GT 750	73-77	210022	B7ES	28,-	35,-				
VS 750 Intruder	86-92	210098	DPR8EA-9	33,-	41,-	215026	DPR8EIX-9	163,-	204,-
DR 800 S	94-99	210099	DPR9EA-9	33,-	41,-	215028	DPR9EIX-9	163,-	204,-
VS 800 GLS/GL	92-00	210098	DPR8EA-9	33,-	41,-	215026	DPR8EIX-9	163,-	204,-
VX 800	90-97	210098	DPR8EA-9	33,-	41,-	215026	DPR8EIX-9	163,-	204,-
VZ 800 Marauder	97-08	210098	DPR8EA-9	33,-	41,-	215026	DPR8EIX-9	163,-	204,-
VL 800 Intruder Volusia	01-10	210097	DPR7EA-9	33,-	41,-	215027	DPR7EIX-9	163,-	204,-
VZ 800 Intruder M 800	05-10	210097	DPR7EA-9	33,-	41,-	215027	DPR7EIX-9	163,-	204,-
M 800 Intruder	07-08	210097	DPR7EA-9	33,-	41,-	215027	DPR7EIX-9	163,-	204,-
C 800 Intruder	07-08	210097	DPR7EA-9	33,-	41,-	215027	DPR7EIX-9	163,-	204,-
GS 850	79-80	210023	B8ES	28,-	35,-	215008	BR8EIX	163,-	204,-
GS 850	81-84	210027	B9ES	28,-	35,-	215010	BR9EIX	163,-	204,-
RF 900	94-00	210078	CR9E	79,-	99,-	215015	CR9EIX	163,-	204,-
GS 1000	78-91	210023	B8ES	28,-	35,-	215008	BR8EIX	163,-	204,-
TL 1000 S/R	97-03	210079	CR9EK	97,-	121,-	215015	CR9EIX	163,-	204,-
SV 1000/S	03-07	210076	CR8EK	97,-	121,-	215013	CR8EIX	163,-	204,-
DL 1000 V-Strom	02-10	210076	CR8EK	97,-	121,-	215013	CR8EIX	163,-	204,-
GSX-R 1000	01-07	210078	CR9E	79,-	99,-	215029	DR9EIX	163,-	204,-
GSX-R 1000	07-10					215019	CR9EIA-9	121,-	151,-
GSX 1100/E	81-83	210087	D8EA	29,-	36,-	215022	DR8EIX	163,-	204,-
GSX 1100 F	88-97	210110	JR9B	62,-	78,-	215029	DR9EIX	163,-	204,-
GSX 1100 EF	84-86	210091	DR8ES	33,-	41,-	215022	DR8EIX	163,-	204,-
GSX 1100 GN	92>	210091	DR8ES	33,-	41,-	215022	DR8EIX	163,-	204,-
GSX R 1100	86-88	210109	JR9A	33,-	41,-				
GSX R 1100	89-92	210112	JR10B	62,-	78,-				
GSX R 1100	93-98	210078	CR9E	79,-	99,-	215015	CR9EIX	163,-	204,-

- Stikord Sökord s. 2-5
- Forhandlere Aterforsäljare s. 6-9
- Tøj/hjelme Klæder/hjälmar s. 11
- Dæk Däck s. 83
- Oljeolja s. 115
- Kæde/tandhjul Kedjor/drev s. 145
- Bremser Broms s. 187
- Låse Lås s. 347
- Batteri Batterier s. 355
- Pakninger Packningar s. 377
- Motordele Motordelar s. 411
- Lejer Lager s. 435
- Karburator Förgasare s. 467
- El-dele/ Tænding Elektriskt/Tänding s. 509
- Blinklygter Baglygter Belysning Baklygter s. 611
- Lyddæmper Avgassystem s. 651
- Støddæmper Støtdämpare s. 681
- Luft-/oliefilter Luft-/oljefilter s. 711
- Kobling Koppling s. 769
- Kabler Wire s. 803
- Styr/greb Styre/handtag s. 829
- Spejle og diverse Speglar och diverse s. 867
- Bøger/værktøj Böcker/verktyg s. 893

Tændrør til motorcykler
Tändstift till motorcyklar



Mærke/ model	Prod. årg.	NGK tændrør Varenr.	NGK nr.	DKK	SEK	Iridium Varenr.	Ref.nr.	DKK	SEK
Mærke/ modell	Prod. årg.	NGK tændrør Art.nr.	NGK nr.	DKK	SEK	Iridium Art.nr.	Ref.nr.	DKK	SEK
SUZUKI									
GSF 1200 Bandit	96-07	210110	JR9B	62,-	78,-	215029	DR9EIX	163,-	204,-
GSX 1200	99	210110	JR9B	62,-	78,-	215029	DR9EIX	163,-	204,-
GSF 1250 Bandit ABS	07-10	210073	CR7E	79,-	99,-	215014	CR7EIX	163,-	204,-
GSX R 1300 Hayabusa	99-07	210078	CR9E	79,-	99,-	215015	CR9EIX	163,-	204,-
GSX 1300 Hayabusa	08-10					215019	CR9EIA-9	121,-	151,-
GSX 1300 B-King	07-10					215019	CR9EIA-9	121,-	151,-
GSX 1400	01-09	210076	CR8EK	97,-	121,-	215013	CR8EIX	163,-	204,-
VS 1400 Intruder	87-01	210098	DPR8EA-9	33,-	41,-	215026	DPR8EIX-9	163,-	204,-
VL 1500 Intruder	98-05	210097	DPR7EA-9	33,-	41,-	215027	DPR7EIX-9	163,-	204,-
VL 1500 Intruder	06->	210097	DPR7EA-9	33,-	41,-	215027	DPR7EIX-9	163,-	204,-
VZ 1600 Marauder	04-06	210096	DPR6EA-9	35,-	44,-				
M 1800 Intruder	06-07	210076	CR8EK	97,-	121,-	215013	CR8EIX	163,-	204,-
M 1800 R2	08->	210076	CR8EK	97,-	121,-	215013	CR8EIX	163,-	204,-
M 1800 RZ	08->	210076	CR8EK	97,-	121,-	215013	CR8EIX	163,-	204,-
C 1800 R	08->	210076	CR8EK	97,-	121,-	215013	CR8EIX	163,-	204,-
TRIUMPH									
600 Daytona	03-04	210079	CR9EK	97,-	121,-	215015	CR9EIX	163,-	204,-
600 Speed Four	02-04	210079	CR9EK	97,-	121,-	215015	CR9EIX	163,-	204,-
600 TT	99-03	210079	CR9EK	97,-	121,-	215015	CR9EIX	163,-	204,-
650 Daytona	05-08	210079	CR9EK	97,-	121,-	215015	CR9EIX	163,-	204,-
675 Daytona/RR	05-10	210079	CR9EK	97,-	121,-	215015	CR9EIX	163,-	204,-
675 Street Triple	07-10	210079	CR9EK	97,-	121,-	215015	CR9EIX	163,-	204,-
750 Sprint RS	00	210098	DPR8EA-9	33,-	41,-	215026	DPR8EIX-9	163,-	204,-
750 Trident 3-cyl.	93-95	210098	DPR8EA-9	33,-	41,-	215026	DPR8EIX-9	163,-	204,-
790 America	05	210098	DPR8EA-9	33,-	41,-	215026	DPR8EIX-9	163,-	204,-
790 Bonneville	00-04	210098	DPR8EA-9	33,-	41,-	215026	DPR8EIX-9	163,-	204,-
790 Bonneville America/T100/Sport	02-09	210098	DPR8EA-9	33,-	41,-	215026	DPR8EIX-9	163,-	204,-
865 Thruxton 900	04	210098	DPR8EA-9	33,-	41,-	215026	DPR8EIX-9	163,-	204,-
865 Bonneville	07-10	210098	DPR8EA-9	33,-	41,-	215026	DPR8EIX-9	163,-	204,-
865 Speedmaster	08-10	210098	DPR8EA-9	33,-	41,-	215026	DPR8EIX-9	163,-	204,-
885 Adventurer 3-cyl.	96-01	210098	DPR8EA-9	33,-	41,-	215026	DPR8EIX-9	163,-	204,-
885 Legend TT	98-01	210098	DPR8EA-9	33,-	41,-	215026	DPR8EIX-9	163,-	204,-
885 Speed Triple	94-00	210098	DPR8EA-9	33,-	41,-	215026	DPR8EIX-9	163,-	204,-
885 Tiger 3-cyl.	93-00	210098	DPR8EA-9	33,-	41,-	215026	DPR8EIX-9	163,-	204,-
900 Adventurer 3-cyl. (885)	96-00	210098	DPR8EA-9	33,-	41,-	215026	DPR8EIX-9	163,-	204,-
900 Daytona 900 3-cyl.	93-96	210098	DPR8EA-9	33,-	41,-	215026	DPR8EIX-9	163,-	204,-
900 Scrambler 900	06	210098	DPR8EA-9	33,-	41,-	215026	DPR8EIX-9	163,-	204,-
900 Sprint Executive, Sport	98-00	210098	DPR8EA-9	33,-	41,-	215026	DPR8EIX-9	163,-	204,-
900 Thunderbird 3-cyl.	95-98	210098	DPR8EA-9	33,-	41,-	215026	DPR8EIX-9	163,-	204,-
900 Thruxton	03-10	210098	DPR8EA-9	33,-	41,-	215026	DPR8EIX-9	163,-	204,-
900 Trident 3-cyl.	93-95	210098	DPR8EA-9	33,-	41,-	215026	DPR8EIX-9	163,-	204,-
900 Trident Sprint 3-cyl.	93-96	210098	DPR8EA-9	33,-	41,-	215026	DPR8EIX-9	163,-	204,-
900 Triumph Super 3	93-94	210098	DPR8EA-9	33,-	41,-	215026	DPR8EIX-9	163,-	204,-
900 Trophy 3-cyl.	93-00	210098	DPR8EA-9	33,-	41,-	215026	DPR8EIX-9	163,-	204,-
955 Daytona, Speed Triple, Sprint ST	01-08	210079	CR9EK	97,-	121,-	215015	CR9EIX	163,-	204,-
955 T 595, Daytona	97-00	210098	DPR8EA-9	33,-	41,-	215026	DPR8EIX-9	163,-	204,-
955 Tiger	01-07	210098	DPR8EA-9	33,-	41,-	215026	DPR8EIX-9	163,-	204,-
1050 Speed Triple	05-09	210098	DPR8EA-9	33,-	41,-	215026	DPR8EIX-9	163,-	204,-
1050 Sprint ST	05-09	210098	DPR8EA-9	33,-	41,-	215026	DPR8EIX-9	163,-	204,-
1050 Tiger	06	210098	DPR8EA-9	33,-	41,-	215026	DPR8EIX-9	163,-	204,-
Tiger 1051 i	07-10	210079	CR9EK	97,-	121,-	215015	CR9EIX	163,-	204,-
1050 Speed Triple	04-10	210079	CR9EK	97,-	121,-	215015	CR9EIX	163,-	204,-
1200 Daytona 4-cyl.	93-96	210098	DPR8EA-9	33,-	41,-	215026	DPR8EIX-9	163,-	204,-
1200 Trophy B626 4-cyl.	93-03	210098	DPR8EA-9	33,-	41,-	215026	DPR8EIX-9	163,-	204,-
1596 Thunderbird	09-10	210096	DPR6EA-9	35,-	44,-				
2300 Rocket III Twinspark	04-10	210098	DPR8EA-9	33,-	41,-	215026	DPR8EIX-9	163,-	204,-
YAMAHA									
PW 50	Alle	210012	BP4HS	29,-	36,-				
PW 80	Alle	210013	BP6HS	26,-	33,-	215006	BPR6HIX	163,-	204,-
BW 50	Alle	210020	BPR7HS	33,-	41,-				
YSR 80	Alle	210004	B8HS	28,-	35,-				
RS 100	Alle	210004	B8HS	28,-	35,-	215007	BR8HIX	163,-	204,-
RD 125 LC	82-84	210023	B8ES	28,-	35,-	215007	BR8HIX	163,-	204,-
DT 125	82-86	210023	B8ES	28,-	35,-	215007	BR8HIX	163,-	204,-
DT 125	87-92	210023	B8ES	28,-	35,-	215007	BR8HIX	163,-	204,-
DT 125 R	93-00	210047	BR9ES	33,-	41,-	215010	BR9EIX	163,-	204,-
TDR 125	94-96	210027	B9ES	28,-	35,-				
YBR 125	07-10	210067	CR6HSA	35,-	44,-				
YZF-R 125	08-10	210075	CR8E	79,-	99,-	215013	CR8EIX	163,-	204,-
DT 175	91-97	210023	B8ES	28,-	35,-	215008	BR8EIX	163,-	204,-
DT 250	80-90	210023	B8ES	28,-	35,-	215008	BR8EIX	163,-	204,-
SR 250	97-99	210055	BP7ES	28,-	35,-	215000	BPR7EIX	163,-	204,-
TZR 250	87->	210047	BR9ES	33,-	41,-	215010	BR9EIX	163,-	204,-

NGK tændrør verdens førende producent af tændrør

NGK er verdens førende producent af tændrør til motorcykelindustrien med fabrikker og kontorer over hele kloden. NGK begyndte i 1936 at fremstille kvalitetstændrør i Japan. Efterfølgende er NGK vokset til en kæmpe koncern med en moderne produktion. NGK investerer store summer i forskning og udvikling inden for motorsport. Det gælder både Formel 1 og motorcykelracing, hvor kun det bedste er godt nok og der ikke er plads til kompromisser. NGK's tændrør lever konstant op til dagens teknologi. Tændrørene har optimale præstationer og lang levetid, samtidig med at de forurener miljøet mindst muligt. Det gælder både i racing og i den daglige trafik.

NGK tændstift Verdens ledende tilverkere af tændstift

NGK är världens ledande tillverkare av tändstift till motorcykelindustri med fabriker över hela världen. NGK startade 1936 med att producera kvalitetständstift i Japan och har sen dess vuxit till en gigantisk koncern med "high tec"-produktion. NGK investerar stora summor på forskning och utveckling inom motorsport. Det gäller både Formel-1 och motorcykelracing där endast det bästa är gott nog och där man inte har utrymme för kompromisser. NGK's tändstift lever konstant upp till dagens krav med lång livslängd och max prestanda samtidigt som de är skonsamma mot miljön genom en så hög förbränning som möjligt. Det gäller både i race och i daglig trafik.

Tændrør til motorcykler
Tändstift till motorcyklar



Mærke/ model	Prod. årg.	NGK tændrør Varenr.	NGK nr.	DKK	SEK	Iridium Varenr.	Ref.nr.	DKK	SEK
Mærke/ modell	Prod. årg.	NGK tændrør Art.nr.	NGK nr.	DKK	SEK	Iridium Art.nr.	Ref.nr.	DKK	SEK
YAMAHA									
TDR 250	88->	210047	BR9ES	33,-	41,-	215010	BR9EIX	163,-	204,-
WR 250 X Motad	08->	210079	CR9EK	97,-	121,-	215015	CR9EIX	163,-	204,-
XS 250	77-79	210055	BP7ES	28,-	35,-	215000	BPR7EIX	163,-	204,-
XT 250	80-90	210055	BP7ES	28,-	35,-	215000	BPR7EIX	163,-	204,-
XV 250 Virago	90-00	210066	CR6HS	35,-	44,-	215016	CR6HIX	163,-	204,-
YP 250 Majesty	95-03	210092	DR8EA	33,-	41,-	215022	DR8EIX	163,-	204,-
RD 350	75-78	210004	B8HS	28,-	35,-	215007	BR8HIX	163,-	204,-
RD 350 LC	81-82	210023	B8ES	28,-	35,-	215007	BR8HIX	163,-	204,-
RD 350 Ypvs	83-85	210044	BR8ES	33,-	41,-	215007	BR8HIX	163,-	204,-
RD 350	85-95	210047	BR9ES	33,-	41,-	215010	BR9EIX	163,-	204,-
XT 350	85-97	210093	DR8ES-L	33,-	41,-	215022	DR8EIX	163,-	204,-
XS 360	77	210054	BP6ES	26,-	33,-	215001	BPR6EIX	163,-	204,-
FZR 400 Genesis	91-97	210075	CR8E	79,-	99,-	215013	CR8EIX	163,-	204,-
RD 400	76-79	210023	B8ES	28,-	35,-	215008	BR8EIX	163,-	204,-
XS 400	78	210055	BP7ES	28,-	35,-	215000	BPR7EIX	163,-	204,-
XS 400	79-82	210055	BP7ES	28,-	35,-	215000	BPR7EIX	163,-	204,-
XS 400 SE	80-82	210055	BP7ES	28,-	35,-	215000	BPR7EIX	163,-	204,-
XS 400 Seca	82-88	210093	DR8ES-L	33,-	41,-	215022	DR8EIX	163,-	204,-
YP 400 Majesty	04-09	210073	CR7E	79,-	99,-	215014	CR7EIX	163,-	204,-
XS 500	76-78	210087	D8EA	29,-	36,-	215022	DR8EIX	163,-	204,-
RD 500	84-85	210005	B9HS	28,-	35,-				
SR 500	78-95	210055	BP7ES	28,-	35,-	215000	BPR7EIX	163,-	204,-
SR 500	96-98	210059	BPR7ES	33,-	41,-	215000	BPR7EIX	163,-	204,-
XP 500 T-Max	00-09	210073	CR7E	79,-	99,-	215014	CR7EIX	163,-	204,-
XV 535	87-92	210055	BP7ES	28,-	35,-	215000	BPR7EIX	163,-	204,-
XV 535	93-03	210059	BPR7ES	33,-	41,-	215000	BPR7EIX	163,-	204,-
XT 500	77-88	210055	BP7ES	28,-	35,-	215000	BPR7EIX	163,-	204,-
XJ 550	80-83	210087	D8EA	29,-	36,-	215022	DR8EIX	163,-	204,-
XZ 550	82-84	210093	DR8ES-L	33,-	41,-	215022	DR8EIX	163,-	204,-
XT 550	82-83	210089	DR7ES	35,-	44,-				
XJ 600	84-90	210093	DR8ES-L	33,-	41,-	215022	DR8EIX	163,-	204,-
XJ 600 Diversion	92-03	210075	CR8E	79,-	99,-	215013	CR8EIX	163,-	204,-
XT 600	87-88	210089	DR7ES	35,-	44,-				
TT 600	84-88	210097	DPR7EA-9	33,-	41,-	215027	DPR7EIX-9	163,-	204,-
TT 600 RE	03-04	210098	DPR8EA-9	33,-	41,-	215026	DPR8EIX-9	163,-	204,-
XT 600 Tenere	87-91	210097	DPR7EA-9	33,-	41,-	215027	DPR7EIX-9	163,-	204,-
XT 600 E	90-03	210098	DPR8EA-9	33,-	41,-	215026	DPR8EIX-9	163,-	204,-
XTZ 660	91-99	210099	DPR9EA-9	33,-	41,-	215028	DPR9EIX-9	163,-	204,-
FZR 600 Genesis	89-93	210078	CR9E	79,-	99,-	215015	CR9EIX	163,-	204,-
FZR 600 R	93-96	210078	CR9E	79,-	99,-	215015	CR9EIX	163,-	204,-
FZS 600 Fazer	98-02	210078	CR9E	79,-	99,-	215015	CR9EIX	163,-	204,-
FZS 600 Fazer/FZ6	03-05	210079	CR9EK	97,-	121,-	215015	CR9EIX	163,-	204,-
YZF 600 R Thundercat	96-03	210078	CR9E	79,-	99,-	215015	CR9EIX	163,-	204,-
YZF R6	99-04	210084	CR10EK	97,-	121,-	215021	CR10EIX	163,-	204,-
YZF-R6	05-07	210079	CR9EK	97,-	121,-	215015	CR9EIX	163,-	204,-
YZF-R6	08-10	210084	CR10EK	97,-	121,-				
FZ6/S	04-10	210079	CR9EK	97,-	121,-	215015	CR9EIX	163,-	204,-
FZ6-N ABS	05->	210079	CR9EK	97,-	121,-	215015	CR9EIX	163,-	204,-
XJ 650	80-85	210055	BP7ES	28,-	35,-	215000	BPR7EIX	163,-	204,-
XJ 650 Turbo	82-83	210060	BPR8ES	33,-	41,-				
XS 650	75-76	210055	BP7ES	28,-	35,-				
XS 650	77-81	210055	BP7ES	28,-	35,-				
XS 650 SE	79-82	210056	BP8ES	29,-	36,-				
XVS 650 Drag Star	97-08	210097	DPR7EA-9	33,-	41,-	215027	DPR7EIX-9	163,-	204,-
MT03	05-10	210073	CR7E	79,-	99,-	215014	CR7EIX	163,-	204,-
SZR 660	95-01	210098	DPR8EA-9	33,-	41,-	215026	DPR8EIX-9	163,-	204,-
XT 660 X/R	04-10	210073	CR7E	79,-	99,-	215014	CR7EIX	163,-	204,-
XT 660 R	04-10	210073	CR7E	79,-	99,-	215014	CR7EIX	163,-	204,-
XT 660 X	04-10	210073	CR7E	79,-	99,-	215014	CR7EIX	163,-	204,-
XT 660 Tenere	08->	210079	CR9EK	97,-	121,-	215015	CR9EIX	163,-	204,-
XJ 700 Maxim	85-90	210056	BP8ES	29,-	36,-				
XS 750	77-79	210022	B7ES	28,-	35,-				
XS 750 C	80-81	210022	B7ES	28,-	35,-				
XJ 750 Seca	82-83	210055	BP7ES	28,-	35,-	215000	BPR7EIX	163,-	204,-
XJ 750	84-86	210056	BP8ES	29,-	36,-				
XV 750	81-84	210022	B7ES	28,-	35,-				
XV 750 C/Virago	90-98	210055	BP7ES	28,-	35,-	215000	BPR7EIX	163,-	204,-
XTZ 750	90-95	210098	BPR8EA-9	33,-	41,-	215026	DPR8EIX-9	163,-	204,-
FZ 750	85-88	210093	DR8ES-L	33,-	41,-	215022	DR8EIX	163,-	204,-
FZR 750 R	88->	210092	DR8EA	33,-	41,-	215022	DR8EIX	163,-	204,-
FZR 750 RW	89-92	210092	DR8EA	33,-	41,-	215022	DR8EIX	163,-	204,-
YZF 750	93-97	210078	CR9E	79,-	99,-	215015	CR9EIX	163,-	204,-
YZF 750 - R7	98-99	210078	CR9E	79,-	99,-	215015	CR9EIX	163,-	204,-
XS 850	80	210055	BP7ES	28,-	35,-	215000	BPR7EIX	163,-	204,-

- Stikord Sökord s. 2-5
- Forhandlere Aterforsäljare s. 6-9
- Tøj/hjelme Klæder/hjälmar s. 11
- Dæk Däck s. 83
- Olie Olja s. 115
- Kæde/tandhjul Kedjor/drev s. 145
- Bremser Broms s. 187
- Låse Lås s. 347
- Batteri Batterier s. 355
- Pakninger Packningar s. 377
- Motordele Motordelar s. 411
- Lejer Lager s. 435
- Karburator Förgasare s. 467
- El-dele/Tænding Elektriskt/Tänding s. 509
- Blinklygter Baglygter Belysning Baklygter s. 611
- Lyddæmper Avgassystem s. 651
- Støddæmper Støtdämpare s. 681
- Luft/oilfilter Luft-/oljefilter s. 711
- Kobling Koppling s. 769
- Kabler Wire s. 803
- Styr/greb Styre/handtag s. 829
- Spejle og diverse Speglar och diverse s. 867
- Bøger/værktøj Böcker/verktyg s. 893

Tændrør til motorcykler
Tændstift till motorcyklar



Mærke/ model	Prod. årg.	NGK tændrør Varenr.	NGK nr.	DKK	SEK	Iridium Varenr.	Ref.nr.	DKK	SEK
Mærke/ modell	Prod. årg.	NGK tændrør Art.nr.	NGK nr.	DKK	SEK	Iridium Art.nr.	Ref.nr.	DKK	SEK
YAMAHA									
TDM 850	91-03	210098	DPR8EA-9	33,-	41,-	215026	DPR8EIX-9	163,-	204,-
TRX 850	96-00	210098	DPR8EA-9	33,-	41,-	215026	DPR8EIX-9	163,-	204,-
TDM 900	02-10	210098	DPR8EA-9	33,-	41,-	215026	DPR8EIX-9	163,-	204,-
XJ 900	83-92	210056	BP8E5	29,-	36,-				
XJ 900 Diversion	95-03	210098	DPR8EA-9	33,-	41,-	215026	DPR8EIX-9	163,-	204,-
XV 920	85-90	210055	BP7E5	28,-	35,-	215000	BPR7EIX	163,-	204,-
XV 1000 SE	83-86	210055	BP7E5	28,-	35,-	215000	BPR7EIX	163,-	204,-
XV 1000 Virago	86-90	210055	BP7E5	28,-	35,-	215000	BPR7EIX	163,-	204,-
FZR 1000	87-88	210093	DR8ES-L	33,-	41,-	215022	DR8EIX	163,-	204,-
FZR 1000	89-90	210093	DR8ES-L	33,-	41,-	215022	DR8EIX	163,-	204,-
FZR 1000	93-95	210093	DR8ES-L	33,-	41,-	215022	DR8EIX	163,-	204,-
GTS 1000	93-00	210098	DPR8EA-9	33,-	41,-	215026	DPR8EIX-9	163,-	204,-
YZF 1000 Thundercat	96-03	210092	DR8EA	33,-	41,-	215022	DR8EIX	163,-	204,-
YZF R1	98-03	210078	CR9E	79,-	99,-	215015	CR9EIX	163,-	204,-
YZF R1/SP	04-09	210079	CR9EK	97,-	121,-	215015	CR9EIX	163,-	204,-
FZS 1000 Fazer	01-08	210078	CR9E	79,-	99,-	215015	CR9EIX	163,-	204,-
FZS 1000	06-10	210079	CR9EK	97,-	121,-	215015	CR9EIX	163,-	204,-
FZ1 /N/ ABS	06-09	210078	CR9E	79,-	99,-	215015	CR9EIX	163,-	204,-
XS 1100	78-82	210054	BP6E5	26,-	33,-	215001	BPR6EIX	163,-	204,-
XS 1100 S	79-82	210054	BP6E5	26,-	33,-	215001	BPR6EIX	163,-	204,-
FJ 1100	84-85	210098	DPR8EA-9	33,-	41,-	215026	DPR8EIX-9	163,-	204,-
XV 1100 Virago	91-98	210055	BP7E5	28,-	35,-	215000	BPR7EIX	163,-	204,-
XVS 1100 Drag Star	99-08	210059	BPR7E5	33,-	41,-	215000	BPR7EIX	163,-	204,-
BT 1100 Bulldog	02-06	210059	BPR7E5	33,-	41,-	215000	BPR7EIX	163,-	204,-
FJ 1200	86-88	210098	DPR8EA-9	33,-	41,-	215026	DPR8EIX-9	163,-	204,-
FJ 1200	89-97	210098	DPR8EA-9	33,-	41,-	215026	DPR8EIX-9	163,-	204,-
XJR 1200	95-98	210098	DPR8EA-9	33,-	41,-	215026	DPR8EIX-9	163,-	204,-
XVZ 12	84-85	210098	DPR8EA-9	33,-	41,-	215026	DPR8EIX-9	163,-	204,-
V-MAX	86-03	210098	DPR8EA-9	33,-	41,-	215026	DPR8EIX-9	163,-	204,-
XJR 1300/SP	99-07	210098	DPR8EA-9	33,-	41,-	215026	DPR8EIX-9	163,-	204,-
FJR 1300 ABS	01-10	210075	CR8E	79,-	99,-	215013	CR8EIX	163,-	204,-
XVZ 13	96-92	210098	DPR8EA-9	33,-	41,-	215027	DPR7EIX-9	163,-	204,-
XVZ 1300 Royal Star	96-01	210097	DPR7EA-9	33,-	41,-	215027	DPR7EIX-9	163,-	204,-
XVS 1300 Midnight Star	07-10	210159	LMAR7A-9	121,-	151,-				
XV 1600 Wild Star	99-05	210097	DPR7EA-9	33,-	41,-	215027	DPR7EIX-9	163,-	204,-
XV 1700 Road Star/Warrior	04-05	210097	DPR7EA-9	33,-	41,-	215027	DPR7EIX-9	163,-	204,-
V-Max 1700	09-10					215019	CR9EIA-9	121,-	151,-
MT 01	05-10	210097	DPR7EA-9	33,-	41,-	215027	DPR7EIX-9	163,-	204,-
XV 1900	06-10	210098	DPR8EA-9	33,-	41,-	215027	DPR7EIX-9	163,-	204,-

NGK tændrør verdens førende producent af tændrør

NGK er verdens førende producent af tændrør til motorcykelindustrien med fabrikker og kontorer over hele kloden. NGK begyndte i 1936 at fremstille kvalitetstændrør i Japan. Efterfølgende er NGK vokset til en kæmpe koncern med en moderne produktion. NGK investerer store summer i forskning og udvikling inden for motorsport. Det gælder både Formel 1 og motorcykelracing, hvor kun det bedste er godt nok og der ikke er plads til kompromisser. NGK's tændrør lever konstant op til dagens teknologi. Tændrørene har optimale præstationer og lang levetid, samtidig med at de forurener miljøet mindst muligt. Det gælder både i racing og i den daglige trafik.

NGK tændstift Verdens ledende tilverkere af tændstift

NGK är världens ledande tillverkare av tændstift till motorcykelindustri med fabriker över hela världen. NGK startade 1936 med att producera kvalitetstændstift i Japan och har sen dess vuxit till en gigantisk koncern med "high tec"-produktion. NGK investerar stora summer på forskning och utveckling inom motorsport. Det gäller både Formel-1 och motorcykelracing där endast det bästa är gott nog och där man inte har utrymme för kompromisser. NGK's tændstift lever konstant upp till dagens krav med lång livslängd och max prestanda samtidigt som de är skonsamma mot miljön genom en så hög förbränning som möjligt. Det gäller både i race och i daglig trafik.

NGK Iridium tændrør referenceliste
NGK Iridium tændstift referencetabell



NGK IRIDIUM tændrør - Ref.liste/NGK IRIDIUM tændstift - Ref.tabell											
Type	NGK Iridium Varenr.			Type	NGK Iridium Varenr.			Type	NGK Iridium Varenr.		
Typ	NGK Iridium Art.nr.	DKK	SEK	Typ	NGK Iridium Art.nr.	DKK	SEK	Typ	NGK Iridium Art.nr.	DKK	SEK
B-rør:				C-rør:				D-rør:			
BPR 7 EIX	215000	163,-	204,-	CR 8 EIX	215013	163,-	204,-	DR 8 EIX	215022	163,-	204,-
BPR 6 EIX	215001	163,-	204,-	CR 7 EIX	215014	163,-	204,-	DCPR 9 EIX	215023	163,-	204,-
BKR 7 EIX	215002	163,-	204,-	CR 9 EIX	215015	163,-	204,-	DCPR 8 EIX	215024	163,-	204,-
BCPR 7 EIX	215003	163,-	204,-	CR 6 HIX	215016	163,-	204,-	DPCR 7 EIX	215025	163,-	204,-
BR 7 HIX	215004	163,-	204,-	CR 9 EHIX-9	215017	163,-	204,-	DPR 8 EIX-9	215026	163,-	204,-
BPR 7 HIX	215005	163,-	204,-	CR 8 EHIX-9	215018	163,-	204,-	DPR 7 EIX-9	215027	163,-	204,-
BR 6 HIX	215006	163,-	204,-	CR 9 EIA-9	215019	121,-	151,-	DPR 9 EIX-9	215028	163,-	204,-
BR 8 HIX	215007	163,-	204,-	CR 8 HIX	215020	163,-	204,-	DR 9 EIX	215029	163,-	204,-
BR 8 EIX	215008	163,-	204,-	CR 10 EIX	215021	163,-	204,-				
BR 10 EIX	215009	163,-	204,-								
BR 9 EIX	215010	163,-	204,-								
BR 6 EIX	215011	163,-	204,-								
BPR 6 HIX	215012	163,-	204,-								



Mere Power med Iridium
Den "hemmelige" side af Iridium IX tændrøret er dens lasersvejset elektrode lavet af Iridium. Takket være dens usædvanlige tynde diameter på 0,6 mm samles spændingen til gnisten, således bedre forbrænding ved alle hastigheder.

Mer Power med Iridium
Den "hemliga" sidan av Iridium IX tændstift är dess lasersvetsade elektroder gjorda av iridium. Tack vare sin ovanliga tunna diameter, 0,6 mm samlar spänning till gnista, vilket bättre förbränning vid alla hastigheter.

NGK tændrør referenceliste
NGK tændstift reference-tabell



NGK STANDARD tændrør - Ref.liste/NGK STANDARD tændstift -Ref.tabell

Type	NGK tændrør Varenr.			Type	NGK tændrør Varenr.			Type	NGK tændrør Varenr.		
Typ	NGK tændstift Art.nr.	DKK	SEK	Typ	NGK tændstift Art.nr.	DKK	SEK	Typ	NGK tændstift Art.nr.	DKK	SEK
B 8 EG	210025	62,-	78,-	BR 9 ES	210047	33,-	41,-	D 9 EA	210088	29,-	36,-
B 9 EG	210028	62,-	78,-	BR 10 ES	210051	35,-	44,-	DCPR 6-E	210150	86,-	108,-
B 10 EG	210041	62,-	78,-	BR 9 EVX	210049	150,-	188,-	DCPR 7-E	210115	57,-	71,-
B 8 EGV	210026	146,-	183,-	BR 8 EVX	210046	150,-	188,-	DCPR 8-E	210116	75,-	94,-
B 9 EGV	210029	146,-	183,-	BR 10 EV	210052	150,-	188,-	DCPR 9-E	210117	64,-	80,-
B 10 EGV	210042	146,-	183,-	BR 5 HS	210007	35,-	44,-	DCPR 8 EKC	210170	97,-	121,-
B 5 ES	210021	29,-	36,-	BR 6 HS	210008	35,-	44,-	DP 7 EA-9	210127	30,-	38,-
B 7 ES	210022	28,-	35,-	BR 7 HS	210009	33,-	41,-	DPR 5 EA-9	210095	35,-	44,-
B 8 ES	210023	28,-	35,-	BR 8 HS	210010	33,-	41,-	DPR 6 EA-9	210096	35,-	44,-
B 9 ES	210027	28,-	35,-	BR 4 HSA	210006	35,-	44,-	DPR 7 EA-9	210097	33,-	41,-
B 10 ES	210030	29,-	36,-	BR 8 HSA	210011	35,-	44,-	DPR 8 EA-9	210098	33,-	41,-
B 8 EVX	210024	105,-	131,-	C 7 E	210070	62,-	78,-	DPR 9 EA-9	210099	33,-	41,-
B 10 EV	210040	105,-	131,-	C 8 E	210071	62,-	78,-	DPR8 EVX-9	210100	150,-	188,-
B 4 H	210000	30,-	38,-	C 9 E	210072	62,-	78,-	DPR9 EVX-9	210101	150,-	188,-
B 5 HS	210001	28,-	35,-	C 6 HSA	210064	29,-	36,-	DPR 9 Z	210103	79,-	99,-
B 6 HS	210002	28,-	35,-	C 7 HSA	210065	29,-	36,-	DPR 8 Z	210102	79,-	99,-
B 7 HS	210003	28,-	35,-	CPR7EA	210154	79,-	99,-	DR 7 EA	210090	35,-	44,-
B 8 HS	210004	28,-	35,-	CPR8E	210085	79,-	99,-	DR 8 EA	210092	33,-	41,-
B 9 HS	210005	28,-	35,-	CPR6EA-9	210172	75,-	94,-	DR 9 EA	210094	33,-	41,-
BCP 7 ET	210057	57,-	71,-	CPR8EA-9	210148	79,-	99,-	DR 8 EB	210167	97,-	121,-
BCPR6ES	210175	45,-	56,-	CR 7 E	210073	79,-	99,-	DR 7 ES	210089	35,-	44,-
BKR 6 EK	210063	58,-	73,-	CR 8 E	210075	79,-	99,-	DR 8 ES	210091	33,-	41,-
BKR 6 E-11	210061	40,-	50,-	CR 9 E	210078	79,-	99,-	DR 8 ES-L	210093	33,-	41,-
BKR 7 E-11	210062	34,-	43,-	CR 10 E	210177	79,-	99,-	ER 9 EH	210104	182,-	228,-
BKR 7 EKC	210169	79,-	99,-	CR 7 EB	210126	79,-	99,-	IFR6L-11	210151	261,-	326,-
BP 6 ES	210054	26,-	33,-	CR 8 EB	210120	75,-	94,-	IFR 8 H-11	210105	259,-	324,-
BP 7 ES	210055	28,-	35,-	CR 9 EB	210156	79,-	99,-	IFR9H-11	210149	259,-	324,-
BP 8 ES	210056	29,-	36,-	CR7EH-9	210074	97,-	121,-	IJR8B9	210152	281,-	351,-
BP 4 HS	210012	29,-	36,-	CR 8 EH-9	210077	97,-	121,-	ILZKAR7B11	210173	275,-	344,-
BP 6 HS	210013	26,-	33,-	CR 9 EH-9	210080	97,-	121,-	IMR 8C-9H	210118	237,-	296,-
BP 7 HS	210014	28,-	35,-	CR8EH-9S	210146	97,-	121,-	IMR 9A-9H	210106	232,-	290,-
BP 8 HS	210015	29,-	36,-	CR8EHNX-9	210082	150,-	188,-	IMR9B-9H	210107	237,-	296,-
BPR 6 ES	210058	33,-	41,-	CR 9 EHVX-9	210083	150,-	188,-	IMR9C-9H	210108	237,-	296,-
BPR 7 ES	210059	33,-	41,-	CR 8 EIB-10	210124	121,-	151,-	IMR9C-9HES	210147	232,-	290,-
BPR 8 ES	210060	33,-	41,-	CR 8 EK	210076	97,-	121,-	IZFR6-11	210155	215,-	269,-
BPR 4 HS	210016	35,-	44,-	CR 9 EK	210079	97,-	121,-	IZFR6F-11	210174	350,-	438,-
BPR 5 HS	210017	36,-	45,-	CR 10 EK	210084	97,-	121,-	JR 9 A	210109	50,-	71,-
BPR 6 HS	210018	33,-	41,-	CR 7 EKB	210125	97,-	121,-	JR 9 B	210110	62,-	78,-
BPR 7 HS	210020	33,-	41,-	CR 8 EKB	210166	97,-	121,-	JR 9 C	210111	79,-	99,-
BPR 6 HSA	210019	35,-	44,-	CR 9 EKB	210168	97,-	121,-	JR 10 B	210112	62,-	78,-
BR 8 ECM	210121	79,-	99,-	CR 9 EKPA	210081	208,-	260,-	KR9CI	210158	182,-	228,-
BR 9 ECM	210048	79,-	99,-	CR 6 HS	210066	35,-	44,-	LMAR7A-9	210159	121,-	151,-
BR 8 EG	210045	79,-	99,-	CR 6 HSA	210067	35,-	44,-	LMAR9D-J	210178	180,-	225,-
BR 9 EG	210050	79,-	99,-	CR 7 HSA	210068	35,-	44,-	MAR 10 A-J	210171	175,-	219,-
BR 10 EG	210053	79,-	99,-	CR 8 HSA	210069	35,-	44,-	R0409-B8	210119	484,-	605,-
BR 7 ES	210043	35,-	44,-	D 7 EA	210086	29,-	36,-	R41 185-8	210113	116,-	145,-
BR 8 ES	210044	33,-	41,-	D 8 EA	210087	29,-	36,-	R69 18B-7	210114	435,-	544,-

- Stikord Sökord s. 2-5
- Forhandlere Aterforsäljare s. 6-9
- Tøj/hjelme Kläder/hjälmar s. 11
- Dæk Däck s. 83
- Oljeolja s. 115
- Kæde/tandhjul Kedjor/drev s. 145
- Bremser Broms s. 187
- Låse Lås s. 347
- Batteri Batterier s. 355
- Pakninger Packningar s. 377
- Motordele Motordelar s. 411
- Lejer Lager s. 435
- Karburator Förgasare s. 467
- El-dele/Tænding Elektriskt/Tænding s. 509
- Blinklygter Baglygter Belysning Baklygter s. 611
- Lyddæmper Avgassystem s. 651
- Støddæmper Støtdåmpare s. 681
- Luft-/oliefilter Luft-/oljefilter s. 711
- Kobling Koppling s. 769
- Kabler Wire s. 803
- Styr/greb Styre/handtag s. 829
- Spejle og diverse Speglar och diverse s. 867
- Bøger/værktøj Böcker/verktyg s. 893

Kort tændrørsnøgle

Passer til 10, 12 og 14 mm. tændrør.

Kort tændstiftsnyckel

Passar till 10, 12 og 14 mm. tändstift.



Ref.nr. 84-04100.

Varenr./art.nr. 172000

DKK

43,-

SEK

54,-

Lang tændrørsnøgle

Lang nøgle til CB Honda, 12 mm. tændrør.

Lång tændstiftsnyckel

Lång nyckel till CB Honda, 12 mm. tändstift.



Ref.nr. 84-04110.

Varenr./art.nr. 172100

DKK

33,-

SEK

41,-

Tændrørsnøgle

Passer på 21 mm tændrør. Kan bruges sammen med 3/8" topnøgle eller 21 mm top- eller ringgaffel.

Tændstiftsnyckel

Passar till 21 mm tändstift. Kan användas med 3/8" toppnyckel eller 21 mm topp- eller ringnyckel.



Ref.nr. 15-001.

Varenr./art.nr. 192008

DKK

105,-

SEK

131,-

Tændrørsnøgle

Passer på 16 mm tændrør. Kan bruges sammen med 1/4" topnøgle eller 17 mm top- eller ringgaffel.

Tændstiftsnyckel

Passar till 16 mm tändstift. Kan användas med 1/4" toppnyckel eller 17 mm topp- eller ringnyckel.



Ref.nr. 15-002

Varenr./art.nr. 192007

DKK

105,-

SEK

131,-

Tændrørsnøgle

til crosser med vandkølet topstykke.

Tændstiftsnyckel

till crossar med vattenkyld top.



Ref.nr. 84-04113.

Varenr./art.nr. 172050

DKK

44,-

SEK

55,-

Tændrørsnøgle 18 mm

Lækker, i blå eloxeret metal. Nøglen er designet, så du kan bruge en skraldenøgle, skruetrækker eller en 21 mm. tændrørs-nøgle ved montering/demontering.

Tændstiftsnyckel 18 mm

Läcker blå eloxerad metall. Nyckel är designad så att du kan använda den hylsnyckel eller till 21 mm tändstiftsnyckel vid montering/demontering.



Varenr./art.nr. 192102

DKK

212,-

SEK

265,-

Tændrørsnøgle 18 mm

Specielt designet til Honda XR 400 S, men passer til mange modeller med 18 mm. tændrør. Udformet så 21 mm. tændrørsnøgle, skraldenøgle eller skruetrækker kan bruges ved montering/demontering.

Tændstiftsnyckel 18 mm

Speciellt designad till Honda XR400S, men passar till många modeller. Utformad så att en 21mm spärnyckel eller skruvmejsel kan användas vid montering



Varenr./art.nr. 08-0175

DKK

206,-

SEK

258,-

Tændrørsnøgle 16 mm

Specielt designet til vandkølede 4-taktere med 16 mm. tændrør. 2-delt, så den kan bruges ved forsat arbejdsvinkel. Top kan også bruges til 19 mm. indvendig bundprop mm.

Tændstiftsnyckel 16 mm

Passar till vattenkylda 4-taktare med 16mm tändstift. Tvådelad så att den kan användas vid en sned vinkel. Den andra delen kan också användas som invändig 19mm nyckel.



Ref.nr. 84-04120

Varenr./art.nr. 08-0239

DKK

222,-

SEK

278,-

🇩🇪 Lambda sensor

Ved forbrænding af brændstoffer kommer en række uskadelige produkter som vand, kuldioxid eller nitrogen. Der vil også opstå farlige stoffer - såsom kulilte, kvælstofoxider og kulbrinter. I mange år har politikere og industrien arbejdet med at reducere denne forurening. Således har hvert nyt køretøj med en benzinmotor, siden slutningen af firserne, været monteret med en katalysator, der reducerer skadelige emissioner. For at katalysatoren bedre kan klare denne opgave, monteres en lambda sonde, der sikrer den bedste driftsbetjning i katalysatoren.

🇸🇪 Lambda sensor

Vid förbränning av bränsle kommer en rad olika produkter fram som vatten, koldioxid och nitrogen. Det uppstår även farliga produkter, så som kolmonoxid kväveoxider och kolväten. I många år har politiker och industrin arbetat med att reducera dessa föroreningar. Således har varje ny motorcykel med bensinmotor, från åttiotalet varit installerad med en katalysator som reducerar föroreningarna. För katalysatorn skall bättre klara detta monterar en lambasond som säkrar den bästa förbränningen i katalysatorn.



Mærke/ Model	Prod. Årg.	Lambda sensor Varenr.	NGK nr.	Ref.nr.	Kubik	kW	Info	DKK	SEK
Märke/ Modell	Prod. Årg.	Lambda sensor Art.nr.	NGK Ref.nr.	Ref.nr.	Kubik	kW	Info	DKK	SEK

APRILIA

RSV 1000 R (Rotax V2)	04.04-	216000	OZA591-SZ1	1767	998	102	915,-	1144,-
RSV 1000 R Factory (Rotax V2)	10.03-	216000	OZA591-SZ1	1767	998	102	915,-	1144,-
Tuono 1000 R (Rotax V2)	03.06-	216000	OZA591-SZ1	1767	998	102	915,-	1144,-
Tuono 1000 R Factory (Rotax V2)	03.06-	216000	OZA591-SZ1	1767	998	102	915,-	1144,-

BMW

F 650 CS	11.01-12.03	216001	OZA447-E28	0427	652	25	1098,-	1373,-
F 650 CS	11.01-12.03	216001	OZA447-E28	0427	652	25	1098,-	1373,-
F 650 GS	09.99-12.03	216001	OZA447-E28	0427	652	37	1098,-	1373,-
F 650 GS Dakar	09.99-12.03	216001	OZA447-E28	0427	652	37	1098,-	1373,-
F 650 CS K14/02	01.04-12.05	216002	OZA630-BM3	0074	652	25	1110,-	1388,-
F 650 CS K14/02	01.04-12.05	216002	OZA630-BM3	0074	652	37	1110,-	1388,-
F 650 GS R13Mü	12.03-12.07	216002	OZA630-BM3	0074	652	25	1110,-	1388,-
F 650 GS R13Mü	12.03-12.07	216002	OZA630-BM3	0074	652	37	1110,-	1388,-
G 650 Xchallenge K15	03.07-	216003	OZA630-BM1	0072	650	39	1110,-	1388,-
G 650 Xmoto K15	03.07-	216003	OZA630-BM1	0072	650	39	1110,-	1388,-
G 650 Xcountry K15	03.07-	216003	OZA630-BM1	0072	650	39	1110,-	1388,-
F 650 GS K72	10.07-	216004	OZA630-BM2	0073	798	25	1110,-	1388,-
F 650 GS K72	10.07-	216004	OZA630-BM2	0073	798	52	1110,-	1388,-
F 800 S K71	12.05-	216004	OZA630-BM2	0073	798	25	1110,-	1388,-
F 800 S K71	12.05-	216004	OZA630-BM2	0073	798	62	1110,-	1388,-
F 800 GS K72	10.07-	216004	OZA630-BM2	0073	798	63	1110,-	1388,-
F 800 ST K71	09.06-	216004	OZA630-BM2	0073	798	25	1110,-	1388,-
F 800 ST K71	09.06-	216004	OZA630-BM2	0073	798	62	1110,-	1388,-
F 800 R K73	12.06-02.09	216004	OZA630-BM2	0073	798	25	1110,-	1388,-
F 800 R K73	12.06-02.09	216004	OZA630-BM2	0073	798	62	1110,-	1388,-
F 800 R K73/02	03.09-	216004	OZA630-BM2	0073	798	25	1110,-	1388,-
F 800 R K73/02	03.09-	216004	OZA630-BM2	0073	798	64	1110,-	1388,-
R 850 R R28	07.02-08.05	216005	OZA522-BM1	0053	848	25	1110,-	1388,-
R 850 R R28	07.02-08.05	216005	OZA522-BM1	0053	848	52	1110,-	1388,-
R 850 RT R22	03.01-12.04	216005	OZA522-BM1	0053	848	52	1110,-	1388,-
R 1100 S 259S	01.03-12.03	216005	OZA522-BM1	0053	1085	72	1110,-	1388,-
R 1150 GS R21	11.01-12.03	216005	OZA522-BM1	0053	1130	63	1110,-	1388,-
R 1150 GS Adventure R21	11.01-09.06	216005	OZA522-BM1	0053	1130	63	1110,-	1388,-
R 1150 R R28	10.02-08.05	216005	OZA522-BM1	0053	1130	63	1110,-	1388,-
R 1150 RS R22	05.01-09.04	216005	OZA522-BM1	0053	1130	70	1110,-	1388,-
R 1150 RT R22	03.01-12.04	216005	OZA522-BM1	0053	1130	70	1110,-	1388,-
K 1200 GT K41GT	11.02-08.05	216005	OZA522-BM1	0053	1171	72	1110,-	1388,-
K 1200 GT K41GT	11.02-08.05	216005	OZA522-BM1	0053	1171	96	1110,-	1388,-
K 1200 GT K44	12.05-10.08	216004	OZA630-BM2	0073	1157	112	1110,-	1388,-
K 1200 LT K589	01.04-07.08	216006	OZA522-BM2	0054	1171	85	1110,-	1388,-
K 1200 RS K41	01.01-12.04	216005	OZA522-BM1	0053	1171	72	1110,-	1388,-
K 1200 RS K41	01.01-12.04	216005	OZA522-BM1	0053	1171	96	1110,-	1388,-
K 1200 R K43	03.05-09.08	216004	OZA630-BM2	0073	1157	120	1110,-	1388,-
K 1200 S K40	06.04-09.08	216004	OZA630-BM2	0073	1157	123	1110,-	1388,-
R 1200 C 259C	06.03-12.04	216005	OZA522-BM1	0053	1170	45	1110,-	1388,-
R 1200 CL K30	02.02-12.04	216005	OZA522-BM1	0053	1170	45	1110,-	1388,-
R 1200 GS K25	11.03-01.08	216003	OZA630-BM1	0072	1170	72	1110,-	1388,-
R 1200 GS K25Mü	10.07-	216003	OZA630-BM1	0072	1170	77	1110,-	1388,-
R 1200 GS Adventure K25Mü	01.08-	216003	OZA630-BM1	0072	1170	77	1110,-	1388,-
R 1200 R K27	12.06-	216003	OZA630-BM1	0072	1170	81	1110,-	1388,-
R 1200 RT K26	10.04-07.09	216003	OZA630-BM1	0072	1170	81	1110,-	1388,-
R 1200 S K29	10.05-12.07	216003	OZA630-BM1	0072	1170	81	1110,-	1388,-
R 1200 ST K28	12.04-07.08	216003	OZA630-BM1	0072	1170	81	1110,-	1388,-
HP2 K25HP	12.05-12.06	216003	OZA630-BM1	0072	1170	77	1110,-	1388,-
HP2 Megamoto K25HP Meg	10.07-10.08	216003	OZA630-BM1	0072	1170	83	1110,-	1388,-
HP2 Sport K29 HP	11.07-04.10	216003	OZA630-BM1	0072	1170	96	1110,-	1388,-
K 1300 GT K44TÜ	10.08-	216004	OZA630-BM2	0073	1293	118	1110,-	1388,-
K 1300 R K43Mü	10.08-	216004	OZA630-BM2	0073	1293	127	1110,-	1388,-
K 1300 S K40Mü	09.08-	216004	OZA630-BM2	0073	1293	129	1110,-	1388,-

Stikord
Sökord
s. 2-5

Forhandlere
Aterforsäljare
s. 6-9

Tøj/hjelme
Klæder/
hjelmar
s. 11

Dæk
Dæk
s. 83

Olie
Olja
s. 115

Kæde/
tandhjul
Kedjor/
drev
s. 145

Bremser
Broms
s. 187

Låse
Lås
s. 347

Batteri
Batterier
s. 355

Pakninger
Packningar
s. 377

Motordele
Motordelar
s. 411

Lejer
Lager
s. 435

Karburator
Förgasare
s. 467

El-dele/
Tænding
Elektrisk/
Tænding
s. 509

Blinklygter
Baglygter
Belysning
Baklygter
s. 611

Lyddæmper
Avgassystem
s. 651

Støddæmper
Støtdämpare
s. 681

Luft-/
oliefilter
Luft-/
oljefilter
s. 711



Kobling
Koppling
s. 769

Kabler
Wire
s. 803

Styr/greb
Styre/
handtag
s. 829

Spejle
og diverse
Speglar
och diverse
s. 867

Bøger/
værktøj
Böcker/
verktyg
s. 893

 Lambda sensor
 Lambda sensor





Märke/Modell	Prod. Årg.	Lambda sensor Varenr.	NGK nr.	Ref.nr.	Kubik	kW	Info		
Märke/Modell	Prod. Årg.	Lambda sensor Art.nr.	NGK Ref.nr.	Ref.nr.	Kubik	kW	Info	DKK	SEK
DUCATI									
Monster 695	06.04-07.08	216009	OZA591-BB3	0066	695	54		1410,-	1763,-
Monster 696	08.08-	216010	OZA591-BA1	6496	696	59	2x	1198,-	1498,-
Monster S2R	04.06-07.08	216009	OZA591-BB3	0066	803	57		1410,-	1763,-
848	09.07-	216009	OZA591-BB3	0066	849	99		1410,-	1763,-
848 S	09.07-	216009	OZA591-BB3	0066	849	99		1410,-	1763,-
GT 1000	01.06-	216009	OZA591-BB3	0066	992	68		1410,-	1763,-
Monster S2R 1000	01.06-07.08	216009	OZA591-BB3	0066	992	70		1410,-	1763,-
Monster S4RS	06.04-07.08	216009	OZA591-BB3	0066	992	96		1410,-	1763,-
Paul Smart 1000	01.06-07.08	216009	OZA591-BB3	0066	992	68		1410,-	1763,-
ST3	01.04-12.07	216009	OZA591-BB3	0066	992	79		1410,-	1763,-
ST3 S	01.04-12.07	216009	OZA591-BB3	0066	992	79	A	1410,-	1763,-
Sport 1000	01.06-	216009	OZA591-BB3	0066	992	68		1410,-	1763,-
Desmosedici RR	07.07-12.08	216009	OZA591-BB3	0066	989	147		1410,-	1763,-
Hypermotard	08.07-	216009	OZA591-BB3	0066	1078	70		1410,-	1763,-
Hypermotard S	08.07-	216009	OZA591-BB3	0066	1078	70		1410,-	1763,-
Monster 1100	01.09-	216009	OZA591-BB3	0066	1078	70		1410,-	1763,-
Monster 1100 S	01.09-	216009	OZA591-BB3	0066	1078	70		1410,-	1763,-
Multistrada 1100	06.06-	216009	OZA591-BB3	0066	1078	70		1410,-	1763,-
Multistrada 1100 S	06.06-	216009	OZA591-BB3	0066	1078	70		1410,-	1763,-
1098	11.06-12.08	216009	OZA591-BB3	0066	1098	119		1410,-	1763,-
1098 S	11.06-12.08	216009	OZA591-BB3	0066	1098	119		1410,-	1763,-
1098 R	01.08-	216009	OZA591-BB3	0066	1098	132		1410,-	1763,-
Streetfighter	01.09-	216009	OZA591-BB3	0066	1099	116		1410,-	1763,-
Streetfighter S	01.09-	216009	OZA591-BB3	0066	1099	116		1410,-	1763,-
1198	01.08-	216009	OZA591-BB3	0066	1198	125		1410,-	1763,-
1198 S	01.08-	216009	OZA591-BB3	0066	1198	125		1410,-	1763,-
HONDA									
Zoomer	3 01.05-	216011	OZA577-H13	6475	50	50		1310,-	1638,-
Pantheon 125i	01.05-	216012	OZA577-H6	0065	125	10		1175,-	1469,-
PS 125i	01.06-	216013	OZA577-H15	0064	125	10		795,-	994,-
SH 125i	01.05-	216013	OZA577-H15	0064	125	10		795,-	994,-
S-Wing 125	01.06-	216013	OZA577-H15	0064	125	10		795,-	994,-
PS 150i	01.06-	216013	OZA577-H15	0064	150	11		795,-	994,-
Pantheon 150i	01.05-	216012	OZA577-H6	0065	150	12		795,-	994,-
SH 150i	01.05-	216013	OZA577-H15	0064	150	11		795,-	994,-
S-Wing 150	01.06-	216013	OZA577-H15	0064	150	11		795,-	994,-
S-Wing 150 ABS	01.06-	216013	OZA577-H15	0064	150	11		795,-	994,-
SH 300	04.07-	216015	ZSJ0002-HG002	6538	279	28		1660,-	2075,-
SH 300 ABS	04.07-	216015	ZSJ0002-HG002	6538	279	28		1660,-	2075,-
Silver Wing 600	02.07-	216016	OZA577-H22	6483	582	37		1095,-	1369,-
Hornet 600	02.07-	216017	OZA656-H3	6493	599	75		1660,-	2075,-
CBR 600 RR	01.07-	216018	OZA577-H24	6484	599	88		1660,-	2075,-
XL 680 Transalp	07.08-	216019	OZA656-H1	6491	680	44		1575,-	1969,-
VT 750	01.07-	216020	OZA577-H19	6476	745	34	Sensor I	2310,-	2888,-
VT 750	01.07-	216021	OZA577-H20	6477	745	34	Sensor II	2310,-	2888,-
VT 750 Shadow	01.07-	216020	OZA577-H19	6476	745	34	Sensor I	2310,-	2888,-
VT 750 Shadow	01.07-	216021	OZA577-H20	6477	745	34	Sensor II	2310,-	2888,-
VT 750 Shadow Spirit	01.07-	216020	OZA577-H19	6476	745	34	Sensor I	2310,-	2888,-
VT 750 Shadow Spirit	01.07-	216021	OZA577-H20	6477	745	34	Sensor II	2310,-	2888,-
VFR 800	01.99-12.99	216022	OZA333-H16	6456	782	80		1660,-	2075,-
VFR 800	01.00-12.00	216023	OZA333-H29	6459	782	80		1660,-	2075,-
VFR 800	01.01-	216024	OZA333-H30	6460	782	80	Sensor I	1910,-	2388,-
VFR 800	01.01-	216025	OZA333-H31	6462	782	80	Sensor II	1910,-	2388,-
XL 1000 Varadeiro	01.03-12.06	216026	OZA577-H7	6471	996	69		1700,-	2125,-
XL 1000 Varadeiro	01.07-	216027	OZA656-H2	6492	996	69		1365,-	1706,-
CBF 1000	01.06-	216028	OZA577-H17	0007	998	72		1635,-	2044,-
CBF 1000 ABS	01.06-	216028	OZA577-H17	0007	998	72		1635,-	2044,-
CBR 1000 RR Fireblade	02.04-12.05	216029	OZA577-H12	6473	998	126		1660,-	2075,-
CBR 1000 RR Fireblade	01.06-12.07	216030	OZA577-H21	6479	998	126		1660,-	2075,-
CBR 1000 RR Fireblade	01.08-	216031	AZD0102-HG009	6576	1000	131		1660,-	2075,-
CBR 1100 XX Super Blackbird	01.03-12.07	216032	AZD0101-HG004	6543	1137	112		1880,-	2350,-
Pan European	01.06-08.07	216033	OZA577-H4	6463	1261	93	Sensor I	1660,-	2075,-
Pan European	01.06-08.07	216034	OZA577-H5	6469	1261	93	Sensor II	1660,-	2075,-
Pan European	09.07-	216035	OZA656-H5	6494	1261	93	Sensor I	1660,-	2075,-
Pan European	09.07-	216036	OZA656-H6	6495	1261	93	Sensor II	1660,-	2075,-
CB 1300	03.08-	216037	AZD0102-HG003	7664	1284	85	Sensor I	1660,-	2075,-
CB 1300	03.08-	216038	AZD0102-HG004	7665	1284	85	Sensor II	1660,-	2075,-
CB 1300 S	03.08-	216037	AZD0102-HG003	7664	1284	85	Sensor I	1660,-	2075,-
CB 1300 S	03.08-	216038	II AZD0102-HG004	7665	1284	85	Sensor	1660,-	2075,-
VTX 1800	01.03-12.05	216039	AZD0101-HG003	6541	1795	71		1795,-	2244,-
GL 1800 Gold Wing	01.07-	216040	AZD0101-HG001	6539	1832	87	Sensor I	1700,-	2125,-
GL 1800 Gold Wing	01.07-	216041	AZD0101-HG002	6540	1832	87	Sensor II	1660,-	2075,-

Lambda sensor
Lambda sensor





Mærke/ Model	Prod. Årg.	Lambda sensor Varenr.	NGK nr.	Ref.nr.	Kubik	kW	Info		
Mærke/ Modell	Prod. Årg.	Lambda sensor Art.nr.	NGK Ref.nr.	Ref.nr.	Kubik	kW	Info	DKK	SEK
HUSQVARNA									
TE 450	09.07-	216042	OZA591-WB1	0010	449	21		710,-	888,-
SM 450 R	09.07-	216042	OZA591-WB1	0010	449	14		710,-	888,-
SM 510 R	09.07-	216042	OZA591-WB1	0010	501	14		710,-	888,-
SM 610	10.06-	216042	OZA591-WB1	0010	576	39		710,-	888,-
HYOSUNG									
GT 650 Naked	01.07-	216042	OZA591-WB1	0010	647	25		710,-	888,-
GT 650 R	01.07-	216042	OZA591-WB1	0010	647	60		710,-	888,-
GV 650	01.07-	216042	OZA591-WB1	0010	647	24		710,-	888,-
GV 650	01.07-	216042	OZA591-WB1	0010	647	59		710,-	888,-
KAWASAKI									
ZX-6R Ninja	01.07-	216043	AZD0101-KJ002	6552	599	25	Sensor I	1660,-	2075,-
ZX-6R Ninja	01.07-	216044	AZD0101-KJ006	6559	599	25	Sensor II	1225,-	1531,-
ZX-6R Ninja	01.07-	216043	AZD0101-KJ002	6552	599	72	Sensor I	1660,-	2075,-
ZX-6R Ninja	01.07-	216044	AZD0101-KJ006	6559	599	72	Sensor II	1225,-	1531,-
ZX-6R Ninja	01.07-	216043	AZD0101-KJ002	6552	599	92	Sensor I	1660,-	2075,-
ZX-6R Ninja	01.07-	216044	AZD0101-KJ006	6559	599	92	Sensor II	1225,-	1531,-
ZX-10R	11.05-05.06	216045	AZD0101-KJ001	6551	998	128		1225,-	1531,-
ZX-10R	06.06-12.07	216046	AZD0101-KJ004	6556	998	129	Sensor I	1225,-	1531,-
ZX-10R	06.06-12.07	216047	AZD0101-KJ005	6558	998	129	Sensor II	1225,-	1531,-
ZX-10R	01.08-	216047	AZD0102-KJ003	6568	998	129	Sensor I	1225,-	1531,-
ZX-10R	01.08-	216049	AZD0102-KJ004	6574	998	129	Sensor II	1225,-	1531,-
ZZR 1400	01.07-12.07	216046	AZD0101-KJ004	6556	998	129	Sensor I	1225,-	1531,-
ZZR 1400	01.07-12.07	216051	AZD0101-KJ008	6561	1352	72	Sensor II	1225,-	1531,-
ZZR 1400	01.07-12.07	216046	AZD0101-KJ004	6556	998	129	Sensor I	1225,-	1531,-
ZZR 1400	01.07-12.07	216051	AZD0101-KJ008	6561	1352	140	Sensor II	1225,-	1531,-
ZZR 1400	01.08-	216052	AZD0102-KJ001	6567	1352	142		1225,-	1531,-
KTM									
690 Enduro	03.08-	216053	AZD0101-VB002	7673	654	45		1275,-	1594,-
690 Supermoto	03.07-	216053	AZD0101-VB002	7673	654	47		1275,-	1594,-
690 Supermoto R	03.08-	216053	AZD0101-VB002	7673	654	46		1275,-	1594,-
690 SMC	03.08-	216053	AZD0101-VB002	7673	654	45		1275,-	1594,-
690 Duke	03.08-	216053	AZD0101-VB002	7673	654	48		1275,-	1594,-
990 Adventure	01.06-	216054	OZA591-VB2	0009	999	25		975,-	1219,-
990 Adventure	01.06-	216054	OZA591-VB2	0009	999	72		975,-	1219,-
990 Adventure S	01.06-	216054	OZA591-VB2	0009	999	72		975,-	1219,-
990 Superduke	01.06-	216054	OZA591-VB2	0009	999	88		975,-	1219,-
990 Superduke R	01.06-	216054	OZA591-VB2	0009	999	88		975,-	1219,-
990 Supermoto	03.08-	216054	OZA591-VB2	0009	999	85		975,-	1219,-
KYMCO									
People S 200i	01.07-	216055	AZD0101-BA001	7667	163	8		1198,-	1498,-
People S 250i	01.07-	216055	AZD0101-BA001	7667	251	15		1198,-	1498,-
Yager GT 200i	06.06-	216056	OZA591-YB1	0011	176	11		1050,-	1313,-
Venox 250 AFI	06.06-	216056	OZA591-YB1	0011	249	21		1050,-	1313,-
Xciting 250i	06.06-	216056	OZA591-YB1	0011	251	16		1050,-	1313,-
MV AGUSTA									
F4 Brutale 910	10.06-12.08	216057	OZA591-BB2	1710	910	100		1075,-	1344,-
Brutale 989 R	01.09-	216057	OZA591-BB2	1710	989	104		1075,-	1344,-
F4 1000R	10.06-12.08	216057	OZA591-BB2	1710	998	128		1075,-	1344,-
Brutale 1078 RR	01.09-	216057	OZA591-BB2	1710	1078	108		1075,-	1344,-
F4 1000CC	07.07-12.08	216057	OZA591-BB2	1710	1078	141		1075,-	1344,-
F4 1078 RR	01.09-	216057	OZA591-BB2	1710	1078	140		1075,-	1344,-
MOTO GUZZI									
Breva V 750 i.e.	01.03-12.05	216058	OZA341-BB1	0036	744	25		1075,-	1344,-
Breva V 750 i.e.	01.03-12.05	216058	OZA341-BB1	0036	744	36		1075,-	1344,-
Breva V 750 i.e.	01.06-	216057	OZA591-BB2	1710	744	36		1075,-	1344,-
Nevada V 750 i.e.	01.06-	216057	OZA591-BB2	1710	744	36		1075,-	1344,-
Breva V 850 i.e.	01.06-	216057	OZA591-BB2	1710	877	53		1075,-	1344,-
Griso V 850 i.e.	01.06-	216057	OZA591-BB2	1710	877	56		1075,-	1344,-
Norge V 850 i.e.	01.06-	216057	OZA591-BB2	1710	877	53		1075,-	1344,-
Breva V 1100	03.04-12.05	216058	OZA341-BB1	0036	1064	62		1075,-	1344,-
Breva V 1100 i.e.	01.06-	216057	OZA591-BB2	1710	1064	63		1075,-	1344,-
California EV	03.04-12.05	216058	OZA341-BB1	0036	1064	55		1075,-	1344,-
California EV Touring	03.04-12.05	216058	OZA341-BB1	0036	1064	55		1075,-	1344,-
California Classic	01.06-12.05	216058	OZA341-BB1	0036	1064	55		1075,-	1344,-
California Classic	01.06-	216057	OZA591-BB2	1710	1064	54		1075,-	1344,-
California Touring	01.06-12.05	216058	OZA341-BB1	0036	1064	55		1075,-	1344,-
California Vintage	01.06-12.05	216058	OZA341-BB1	0036	1064	55		1075,-	1344,-
California Vintage	01.06-	216057	OZA591-BB2	1710	1064	54		1075,-	1344,-
Griso V 1100 i.e.	01.06-	216057	OZA591-BB2	1710	1064	65		1075,-	1344,-
V11 Café Sport	03.04-12.04	216058	OZA341-BB1	0036	1064	67		1075,-	1344,-

- Stikord Søkord s. 2-5
- Forhandlere Aterforsaljare s. 6-9
- Tøj/hjelme Klæder/hjælmar s. 11
- Dæk Däck s. 83
- Olje Olja s. 115
- Kæde/tandhjul Kedjor/drev s. 145
- Bremser Broms s. 187
- Låse Lås s. 347
- Batteri Batterier s. 355
- Pakninger Packningar s. 377
- Motordele Motordelar s. 411
- Lejer Lager s. 435
- Karburator Förgasare s. 467
- El-dele/Tænding Elektriskt/Tænding s. 509
- Blinklygter Baglygter Belysning Baklygter s. 611
- Lyddæmper Avgassystem s. 651
- Støddæmper Støtdåmpare s. 681
- Luft/oliefilter Luft/oljefilter s. 711
- Kobling Koppling s. 769
- Kabler Wire s. 803
- Styr/greb Styre/handtag s. 829
- Spejle og diverse Speglar och diverse s. 867
- Bøger/værktøj Böcker/verktyg s. 893

 Lambda sensor
 Lambda sensor



Märke/Modell	Prod. Årg.	Lambda sensor Varenr.	NGK nr.	Ref.nr.	Kubik	kW	Info		
Märke/Modell	Prod. Årg.	Lambda sensor Art.nr.	NGK Ref.nr.	Ref.nr.	Kubik	kW	Info	DKK	SEK
MOTO GUZZI									
V11 Coppa Italia	03.04-12.05	216058	OZA341-BB1	0036	1064	67		1075,-	1344,-
V11 Le Mans	03.04-12.05	216058	OZA341-BB1	0036	1064	67		1075,-	1344,-
V11 Le Mans Nero	03.04-12.05	216058	OZA341-BB1	0036	1064	67		1075,-	1344,-
V11 Le Mans Rosso Corsa	03.04-12.05	216058	OZA341-BB1	0036	1064	67		1075,-	1344,-
V11 Scura R	01.05-12.05	216058	OZA341-BB1	0036	1064	67		1075,-	1344,-
V11 Sport Ballabio	03.04-12.05	216058	OZA341-BB1	0036	1064	67		1075,-	1344,-
Norge V 1200 i.e.	01.06-	216057	OZA591-BB2	1710	1151	66		1075,-	1344,-
Sport V 1200 i.e.	01.06-	216057	OZA591-BB2	1710	1151	70		1075,-	1344,-
Stelvio 1200 4V	01.09-	216057	OZA591-BB2	1710	1151	81		1075,-	1344,-
MOTO MORINI									
Corsaro 1200	01.05-	216058	OZA341-BB1	0036	1187	103		1075,-	1344,-
9 1/2	01.05-	216058	OZA341-BB1	0036	1187	86		1075,-	1344,-
PEUGEOT									
Geopolis 125	03.06-	216059	OZA591-SZ1	1767	125	11		915,-	1144,-
Satelis 125	03.06-	216059	OZA591-SZ1	1767	125	11		915,-	1144,-
Satelis 125 K15 Compressor	03.06-	216059	OZA591-SZ1	1767	125	11		915,-	1144,-
Satelis 125 K20 Compressor	03.06-	216059	OZA591-SZ1	1767	125	15		915,-	1144,-
ROYAL ENFIELD									
Bullet 500 Classic	01.09-	216060	AZD0101-VB001	7672	499	20		1360,-	1700,-
Bullet 500 Electra	01.09-	216060	AZD0101-VB001	7672	499	20		1360,-	1700,-
SUZUKI									
RV 125 VanVan	01.07-	216061	AZD0101-SU002	6547	125	9		1870,-	2338,-
GSX-R 600	03.06-12.07	216062	OZA448-J4	0003	599	91		1870,-	2338,-
GSX-R 600	01.08-	216063	AZD0101-SU005	7671	599	91		1870,-	2338,-
DL 650 V-Strom	03.06-	216064	OZA591-J2	6454	645	25		1870,-	2338,-
DL 650 V-Strom	03.06-	216064	OZA591-J2	6454	645	49		1870,-	2338,-
SV 650	01.07-	216063	AZD0101-SU005	7671	645	25		1870,-	2338,-
SV 650 S	02.07-	216063	AZD0101-SU005	7671	645	25		1870,-	2338,-
SV 650	01.07-	216063	AZD0101-SU005	7671	645	53		1870,-	2338,-
SV 650 S	02.07-	216063	AZD0101-SU005	7671	645	53		1870,-	2338,-
GSX-R 750	03.06-12.07	216062	OZA448-J4	0003	750	110		1870,-	2338,-
GSX-R 750	01.08-	216063	AZD0101-SU005	7671	750	110		1870,-	2338,-
VL 800 Intruder	05.04-	216065	AZD0101-SU001	6545	805	39		1870,-	2338,-
DL 1000 V-Strom	05.02-12.06	216066	OZA448-J2	6414	996	72		1870,-	2338,-
TL 1000	05.07-12.00	216067	OZA448-J3	6415	996	92		1870,-	2338,-
GSX-R 1000	01.07-	216068	AZD0101-SU004	7668	999	136		1675,-	2094,-
Bandit 1200	11.06-12.07	216063	AZD0101-SU005	7671	1157	72		1870,-	2338,-
Bandit 1200 S	11.06-12.07	216063	AZD0101-SU005	7671	1157	72		1870,-	2338,-
GSX-R 1300 Hayabusa	05.02-12.06	216069	OZA448-J1	6413	1299	129		1870,-	2338,-
GSX-R 1300 Hayabusa	05.07-	216068	AZD0101-SU004	7668	1299	129		1675,-	2094,-
VL 1500 Intruder	01.06-	216061	AZD0101-SU002	6547	1462	49		1870,-	2338,-
M 1800 R	04.06-12.07	216072	OZA448-J5	0004	1783	92		1870,-	2338,-
VZR 1800 Intruder	01.08-	216073	OZA582-J3	6446	1783	92		1675,-	2094,-
VZR 1800 Intruder	01.08-	216074	OZA582-J4	6447	1783	92		1675,-	2094,-
TRIUMPH									
Daytona 600	01.03-12.05	216075	OZA591-UB1	0067	599	25		1450,-	1813,-
Daytona 600	01.03-12.05	216075	OZA591-UB1	0067	599	72		1450,-	1813,-
Daytona 600	01.03-12.05	216075	OZA591-UB1	0067	599	82		1450,-	1813,-
Speed Four	01.02-	216075	OZA591-UB1	0067	599	25		1450,-	1813,-
Speed Four	01.02-	216075	OZA591-UB1	0067	599	72		1450,-	1813,-
Daytona 675	01.07-	216076	AZD0101-VB003	7689	675	25		1360,-	1700,-
Daytona 675	01.07-	216076	AZD0101-VB003	7689	675	72		1360,-	1700,-
Daytona 675	01.07-	216076	AZD0101-VB003	7689	675	91		1360,-	1700,-
Street Triple 675	01.08-	216076	AZD0101-VB003	7689	675	25		1360,-	1700,-
Street Triple 675	01.08-	216076	AZD0101-VB003	7689	675	78		1360,-	1700,-
Thunderbird Sport	01.03-12.04	216075	OZA591-UB1	0067	855	67		1450,-	1813,-
America	01.07-	216076	AZD0101-VB003	7689	865	25		1360,-	1700,-
America	01.07-	216076	AZD0101-VB003	7689	865	41		1360,-	1700,-
Bonneville	01.07-	216076	AZD0101-VB003	7689	865	25		1360,-	1700,-
Bonneville	01.07-	216076	AZD0101-VB003	7689	865	50		1360,-	1700,-
Scrambler	01.07-	216076	AZD0101-VB003	7689	865	25		1360,-	1700,-
Scrambler	01.07-	216076	AZD0101-VB003	7689	865	42		1360,-	1700,-
Thruxton	01.07-	216076	AZD0101-VB003	7689	865	25		1360,-	1700,-
Thruxton	01.07-	216076	AZD0101-VB003	7689	865	51		1360,-	1700,-
Daytona	72 01.01-	216075	OZA591-UB1	0067	955i	955		1450,-	1813,-
Daytona	108 01.01-	216075	OZA591-UB1	0067	955i	955		1450,-	1813,-
Speed Triple	01.01-12.05	216075	OZA591-UB1	0067	955	72		1450,-	1813,-
Speed Triple	01.01-12.04	216075	OZA591-UB1	0067	955	108		1450,-	1813,-
Sprint RS	01.01-12.04	216075	OZA591-UB1	0067	955	72		1450,-	1813,-
Sprint RS	01.01-12.04	216075	OZA591-UB1	0067	955	108		1450,-	1813,-
Sprint ST	01.01-12.04	216075	OZA591-UB1	0067	955	72		1450,-	1813,-

 Lambda sensor
 Lambda sensor

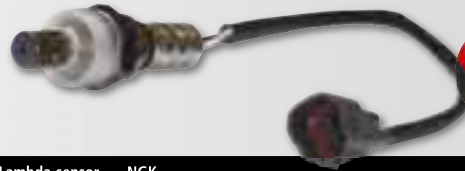

Märke/Modell	Prod. Årg.	Lambda sensor Varenr.	NGK nr.	Ref.nr.	Kubik	kW	Info		
Märke/Modell	Prod. Årg.	Lambda sensor Art.nr.	NGK Ref.nr.	Ref.nr.	Kubik	kW	Info	DKK	SEK
TRIUMPH									
Sprint ST	01.01-12.04	216075	OZA591-UB1	0067	955	108		1450,-	1813,-
Tiger	01.03-12.06	216075	OZA591-UB1	0067	955	72		1450,-	1813,-
Tiger	01.07-	216077	AZD0101-VB002	7673	1050	72		1360,-	1700,-
Tiger	01.04-12.06	216075	OZA591-UB1	0067	955	78		1450,-	1813,-
Tiger	01.07-	216077	AZD0101-VB002	7673	1050	84		1360,-	1700,-
Sprint ST	01.05-12.07	216075	OZA591-UB1	0067	1050	72		1450,-	1813,-
Sprint ST	01.08-	216077	AZD0101-VB002	7673	1050	72		1360,-	1700,-
Sprint ST	01.05-12.07	216075	OZA591-UB1	0067	1050	92		1450,-	1813,-
Sprint ST	01.08-	216077	AZD0101-VB002	7673	1050	93		1360,-	1700,-
Speed Triple	01.06-12.07	216075	OZA591-UB1	0067	1050	72		1450,-	1813,-
Speed Triple	01.08-	216077	AZD0101-VB002	7673	1050	72		1360,-	1700,-
Speed Triple	01.05-12.07	216075	OZA591-UB1	0067	1050	95		1450,-	1813,-
Speed Triple	01.08-	216077	AZD0101-VB002	7673	1050	97		1360,-	1700,-
Thunderbird	01.09-	216078	AZD0101-VB004	7690	1599	59		1360,-	1700,-
Rocket III	01.04-12.04	216079	OZA591-UB2	0008	2294	104		1360,-	1700,-
Rocket III	01.05-12.06	216079	OZA591-UB2	0008	2294	72		1360,-	1700,-
Rocket III Classic	01.06-12.06	216079	OZA591-UB2	0008	2294	72		1360,-	1700,-
Rocket III	01.07-	216077	AZD0101-VB002	7673	2294	72		1360,-	1700,-
Rocket III	01.05-12.06	216079	OZA591-UB2	0008	2294	103		1360,-	1700,-
Rocket III Classic	01.06-12.06	216079	OZA591-UB2	0008	2294	103		1360,-	1700,-
Rocket III	01.07-	216077	AZD0101-VB002	7673	2294	103		1360,-	1700,-



- Stikord Sökord s. 2-5
- Forhandlere Aterforsäljare s. 6-9
- Töj/hjelme Kläder/hjälmor s. 11
- Däck Däck s. 83
- Olje Olja s. 115
- Kæde/tandhjul Kedjor/drev s. 145
- Bremser Broms s. 187
- Låse Lås s. 347
- Batteri Batterier s. 355
- Pakninger Packningar s. 377
- Motordele Motordelar s. 411
- Lejer Lager s. 435
- Karburator Förgasare s. 467
- El-dele/ Tænding Elektriskt/ Tænding s. 509**
- Blinklygter Baglygter Belysning Baklygter s. 611
- Lyddæmper Avgassystem s. 651
- Støddæmper Støtdåmpere s. 681
- Luft-/oliefilter Luft-/oljefilter s. 711
- Kobling Koppling s. 769
- Kabler Wire s. 803
- Styr/greb Styre/handtag s. 829
- Spejle og diverse Speglar och diverse s. 867
- Bøger/værktøj Bøcker/verktyg s. 893

Tændrør til motorcykler Tændstift till motorcyklar

Champion tændrør

Ferrari bruger også Champion tændrør

Champion tændstift

Ferrari anvender også Champion tændstift

I enhver forbrændingsmotor er det tændingen og forbrændingen, der frigiver kræfterne. Dagens utrolig avancerede forbrændingsmotorer kræver bedre tændings-systemer end nogensinde. Perfektion i design og fremstilling er afgørende, men ikke længere nok. I dag kan de ultrahøje præstationer kun nås ved at udvikle tændings-systemerne som en integreret helhed. Champion er mestre i dette system. Champion tændrør er produceret siden 1907 og hører i dag til verdens mest avancerede tændrør. Champions avancerede teknologi gør blandt andet, at Ferrari bruger Champion tændrør i deres Formel 1-biler.

I varje förbränningsmotor är det tändningen och förbrändingen som frigör krafterna och dagens otroligt avancerade motorer kräver bättre tändning än någonsin tidigare. Perfektion i design och tillverkning är avgörande och idag kan ultrahöga prestationer bara nås vid att utveckla tändsystem som en hel integrerad enhet. Champion är mästare på ust detta. Champion har tillverkat tändstift sedan 1907 och räknas idag som världens mest avancerade tändstift. Champions avancerade teknologi gör bland annat att Ferrari använder Champion tändstift till sina Formel-1 bilar och om tändstiften är tillräckligt bra till Ferrari så är de också bra nog till dig...



Mærke/ model	Prod. årg.	CHAMPION tændrør Varenr. Type		
Mærke/ modell	Prod. årg.	CHAMPION tændrør Art.nr. Type	DKK	SEK
APRILIA				
RS 250 Racing Replica				
Liquidcooled 2-stroke 250		091324 QN84		
RX 250		091325 RN2C	36,-	45:-
Tuareg Rally 250		091324 QN84		
Climber Trials 280 /R		091309 N12YC	28,-	35:-
TX 300, 311, 312 - 280		091309 N12YC	28,-	35:-
TR 320		091324 QN84		
ETX 350	86-93			
Tuareg Wind 350	86-93			
Atlantic 500	05-06	091327 RG6YC	80,-	100:-
Atlantic 500 Sprint 500	01-04	091327 RG6YC	80,-	100:-
Scaabeo 500	02->	091327 RG6YC	80,-	100:-
Pegaso 600	86-93			
Tuareg 600 Wind	87-92			
Moto 6.5 Starck 650	95->			
Pegaso i.e. / Garda 650	94-00			
Pegaso MX/ML Yam. MT-03	01-04	091332 RAX92C	49,-	61:-
Pegaso Strada 650	05->	091329 RG96C	136,-	170:-
ETV Capo Nord 1000	01-03	091326 RA4HC	50,-	63:-
ETV Capo Nord 1000	04-05	091326 RA4HC	50,-	63:-
RST Futura 1000	01-03	091326 RA4HC	50,-	63:-
RSV 1000	06->	091326 RA4HC	50,-	63:-
RSV Mille 1000 Twin Spark	98-00	091326 RA4HC	50,-	63:-
RSV Mille MED 1000	99-01	091333 G54V	355,-	444:-
RSV Mille R/RP 1000	99-01	091326 RA4HC	50,-	63:-
RSV Mille R 1000	03->	091326 RA4HC	50,-	63:-
RSV Mille R Nera 1000	04->	091326 RA4HC	50,-	63:-
RSV Mille Tuono 1000	04->	091326 RA4HC	50,-	63:-
RSV R Factory 1000	03-04	091326 RA4HC	50,-	63:-
RSV SP 1000	03->	091326 RA4HC	50,-	63:-
SL Falco 1000	00-03	091326 RA4HC	50,-	63:-

BENELLI

Mærke/ model	Prod. årg.	CHAMPION tændrør Varenr. Type		
Mærke/ modell	Prod. årg.	CHAMPION tændrør Art.nr. Type	DKK	SEK
Sei 750		091334 8809	54,-	68:-
900 L.E.	02->	091335 8654	67,-	84:-
Sei 900	79->	091334 8809	54,-	68:-
Tornado 900	01-02	091335 8654	67,-	84:-
Tornado 900 / Biposto 900	02-03	091335 8654	67,-	84:-
Tornado 900 Tre	05->	091335 8654	67,-	84:-
Tornado 900 Tre RS	04->	091335 8654	67,-	84:-
TNT 1130	04->	091323 RG4HC	124,-	155:-
TNT 1130 Cafe Racer Sport	06->	091323 RG4HC	124,-	155:-
TNT 1130, Sport	06->	091323 RG4HC	124,-	155:-

BSA

Mærke/ model	Prod. årg.	CHAMPION tændrør Varenr. Type		
Mærke/ modell	Prod. årg.	CHAMPION tændrør Art.nr. Type	DKK	SEK
125 Tracker		091318 RN3C	36,-	45:-
175 Bantam D10, D14, D14/4, D14/5		091301 RN4C	28,-	35:-
Bushman 175		091351 RN4C	38,-	48:-
Tracker 175		091318 RN3C	36,-	45:-
B 25 R 250		091318 RN3C	36,-	45:-
B25 Starfire/B25 T Victor 250		091318 RN3C	36,-	45:-
C11 Iron Head 250		091336 RL82C	36,-	45:-
SS Gold Star 250		091318 RN3C	36,-	45:-
B 31 350		091303 L82C	28,-	35:-
B 40 350		091351 RN4C	38,-	48:-
B 40 SS90 350		091319 RN5C	36,-	45:-
Victor B44ET/GP/R/S/VS		091351 RN4C	38,-	48:-
A 50 500		091318 RN3C	36,-	45:-
A 50 C/CC 500		091351 RN4C	38,-	48:-
A50W 500		091318 RN3C	36,-	45:-
A7 500		091351 RN4C	38,-	48:-
B33 500		091351 RN4C	38,-	48:-
B33 Gold Star 500		091336 RL82C	36,-	45:-
B33 Iron Head 500		091318 RN3C	36,-	45:-
B34 500		091351 RN4C	38,-	48:-
B34 Gold Star 500		091336 RL82C	36,-	45:-
B34 Iron Head 500		091318 RN3C	36,-	45:-
B50 MX 500		091318 RN3C	36,-	45:-
B50 SS 500		091351 RN4C	38,-	48:-
B50 T Victor 500		091351 RN4C	38,-	48:-
Gold Star 500		091351 RN4C	38,-	48:-
M33 Iron Head 500		091336 RL82C	36,-	45:-
Victor 500		091318 RN3C	36,-	45:-
M21 Iron Head 600		091319 RN5C	36,-	45:-

Mærke/ model	Prod. årg.	CHAMPION tændrør Varenr. Type		
Mærke/ modell	Prod. årg.	CHAMPION tændrør Art.nr. Type	DKK	SEK
APRILIA				
AF1 Replica 2-stroke 125		091324 QN84		
AF1 Sport 125		091324 QN84		
ASR 125		091325 RN2C	36,-	45:-
Atlantic 125	03->	091327 RG6YC	80,-	100:-
Classic 2-stroke 125		091324 QN84		
Climber 125		091309 N12YC	28,-	35:-
ETX Tuareg 2-stroke 125		091325 RN2C	36,-	45:-
Europa Replica 2-stroke 125		091324 QN84		
Futura Sport Production 125		091324 QN84		
Habana City Aircooled 4-st.	00->	091329 RG96C	136,-	170:-
Habana Custom City Airc.	00->	091329 RG96C	136,-	170:-
Leonardo 2-stroke 125	96-04	091323 RG4HC	124,-	155:-
MX 2-stroke 125	04->	091325 RN2C	36,-	45:-
Pegaso RX 2-stroke 125		091324 QN84		
Red Rose 2-stroke 125		091324 QN84		
RS Liquid cooled 2-stroke	93->	091330 C55CX	124,-	155:-
RS Extrema 2-stroke 125	95->	091324 QN84		
RS Racing Replica 2-stroke	93-96	091324 QN84		
RX 125		091324 QN84		
Scarabeo 4-stroke 125	99->	091329 RG96C	136,-	170:-
Scarabeo 4-stroke 125	01->	091327 RG6YC	80,-	100:-
Sintesi Sport 2-stroke 125		091324 QN84		
Sport City 125	04->	091327 RG6YC	80,-	100:-
Sport Pro 125		091324 QN84		
SR Sport Aircooled 2-stroke	00->	091325 RN2C	36,-	45:-
Strada 125 / R		091325 RN2C	36,-	45:-
Tuareg Rally, Wind 2-stroke		091324 QN84		
Atlantic 150 2-stroke	03->	091323 RG4HC	124,-	155:-
Leonardo 2-stroke 150	97-04	091323 RG4HC	124,-	155:-
Scarabeo 2-stroke 150	98->	091315 RG94C	92,-	115:-
SR 2-stroke 150	99->	091325 RN2C	36,-	45:-
Atlantic 200	04->	091323 RG4HC	124,-	155:-
Sportcity 200 (4-takt)	06->	091327 RG6YC	80,-	100:-
Trials 240	85-93	091331 N11YC	30,-	38:-
TX 240	85-93	091331 N11YC	30,-	38:-
Cross 250		091324 QN84		
Leonardo 250	99-03			

Tændrør til motorcykler
Tændstift till motorcyklar



Mærke/ model	Prod. årg.	CHAMPION tændrør Varenr. Type		
Mærke/ modell	Prod. årg.	CHAMPION tændrør Art.nr. Type	DKK	SEK
BSA				
A 10 Golden Flash 650		091351 RN4C	38,-	48,-
A 10 Super Rocket 650		091351 RN4C	38,-	48,-
A 65 FS, L, SS 650		091351 RN4C	38,-	48,-
A 65 LC, R, T, H 650		091351 RN4C	38,-	48,-
Firebird 650		091318 RN3C	36,-	45,-
Lightning 650		091318 RN3C	36,-	45,-
Thunderbolt 650		091318 RN3C	36,-	45,-
A 75 Rocket 3, 750		091318 RN3C	36,-	45,-

BUELL				
Mærke/ model	Prod. årg.	CHAMPION tændrør Varenr. Type		
Mærke/ modell	Prod. årg.	CHAMPION tændrør Art.nr. Type	DKK	SEK
Blast 492	01-05	091306 RA8HC	38,-	48,-
XB9S Lighting 984	87->	091326 RA4HC	50,-	63,-
XBR9R Firebolt V-Twin 984	87->	091326 RA4HC	50,-	63,-
RR 1000	87-88	091326 RA4HC	50,-	63,-
M2 Cyclone 4-stroke 1200	97->	091326 RA4HC	50,-	63,-
RR, RS, RSS 1200	89-94	091306 RA8HC	38,-	48,-
S1 Lightning 4-stroke 1200	96-98	091326 RA4HC	50,-	63,-
S1 White Lightning 1200	98->	091326 RA4HC	50,-	63,-
Thunderbolt S2, S2T 1200	95-96	091306 RA8HC	38,-	48,-
Thunderbolt S3, S3T 1200	97->	091326 RA4HC	50,-	63,-
Ulysses XB12X 1200 4-stroke	05->	091326 RA4HC	50,-	63,-
X1 Lightning 1200 4-stroke	99-03	091326 RA4HC	50,-	63,-

CAGIVA				
Mærke/ model	Prod. årg.	CHAMPION tændrør Varenr. Type		
Mærke/ modell	Prod. årg.	CHAMPION tændrør Art.nr. Type	DKK	SEK
Ala Azzurra Ducati mot. 600		091312 RL82YC	36,-	45,-
Canyon 600 4-stroke	96-99	091338 C6YCC	40,-	50,-
River 600 4-stroke	95-99	091338 C6YCC	40,-	50,-
W16 600 4-stroke	94-95	091338 C6YCC	40,-	50,-
Ala Azzurra Ducati mot. 650		091312 RL82YC	36,-	45,-
Elefant 650		091312 RL82YC	36,-	45,-
Raptor 650	01->	091315 RG94C	92,-	115,-
V Raptor 650	01->	091315 RG94C	92,-	115,-
Elefant Lucky 750 'cat' 4-str.		091312 RL82YC	36,-	45,-
Elefant 'cat' 900		091339 RA6HC	36,-	45,-
Elefant GT 900		091326 RA4HC	50,-	63,-
Elefant i.e. 900 4-stroke		091326 RA4HC	50,-	63,-
Gran Canyon 900 4-stroke		091339 RA6HC	36,-	45,-
Navigator Fi 1000 LC	02/00>	091340 RG92DC	84,-	105,-
Raptor Fi LC 1000	02/00>	091340 RG92DC	84,-	105,-
V-Raptor Fi LC 1000	02/00>	091340 RG92DC	84,-	105,-

DUCATI				
Mærke/ model	Prod. årg.	CHAMPION tændrør Varenr. Type		
Mærke/ modell	Prod. årg.	CHAMPION tændrør Art.nr. Type	DKK	SEK
Regularità 125		091341 QL55	150,-	188,-
Scrambler 125		091342 L86C	28,-	35,-
Six Days 125		091341 QL55	150,-	188,-
S 160		091342 L86C	28,-	35,-
TS 160		091342 L86C	28,-	35,-
TS 200		091342 L86C	28,-	35,-
24 Hrs 250		091336 RL82C	36,-	45,-
Daytona 250		091344 L78C	36,-	45,-
Desmo 250		091336 RL82C	36,-	45,-
Mk III 250		091341 QL55	150,-	188,-
Strada 250		091342 L86C	28,-	35,-
3 Mk III, D 350		091336 RL82C	36,-	45,-
Desmo, Sport 350		091336 RL82C	36,-	45,-
Forza 350		091342 L86C	28,-	35,-
GLT 350		091336 RL82C	36,-	45,-
GTV 350		091336 RL82C	36,-	45,-
Indiana 350		091336 RL82C	36,-	45,-
Mono 350		091312 RL82YC	36,-	45,-
Sport 4-stroke 350		091309 N12YC	28,-	35,-
Vento 350		091342 L86C	28,-	35,-
XL 350		091312 RL82YC	36,-	45,-
Monster 400 AC 398	00->	091312 RL82YC	36,-	45,-
SS Supersport 400		091312 RL82YC	36,-	45,-
Desmo, Mk III/mk Mk III D 450		091336 RL82C	36,-	45,-
Desmo RT 450		091336 RL82C	36,-	45,-
Regularità 450		091336 RL82C	36,-	45,-
Scrambler 450		091336 RL82C	36,-	45,-
TS 450		091336 RL82C	36,-	45,-
Desmo 500 / GTL / GTV 5		091336 RL82C	36,-	45,-
Pantah 500 / SL		091312 RL82YC	36,-	45,-
Sport 500		091336 RL82C	36,-	45,-
V2 500		091312 RL82YC	36,-	45,-
Supermono 550	93->	091345 QA55V	177,-	221,-

Mærke/ model	Prod. årg.	CHAMPION tændrør Varenr. Type		
Mærke/ modell	Prod. årg.	CHAMPION tændrør Art.nr. Type	DKK	SEK
DUCATI				
Monster 600 Dark, City AC				
4-stroke 583		091339 RA6HC	36,-	45,-
Pantah 600 SL, TL 583		091312 RL82YC	36,-	45,-
SS 600 4-stroke 583		091326 RA4HC	50,-	63,-
Monster 620 i.e. 618/Sport	03->	091326 RA4HC	50,-	63,-
Monster 620S i.e. Dark 618	03->	091326 RA4HC	50,-	63,-
Monster i.e. Injectio 620	01->	091339 RA6HC	36,-	45,-
Indiana 650		091312 RL82YC	36,-	45,-
Monster 695	07->	091326 RA4HC	50,-	63,-
748 LC	00->	091322 RA59GC	106,-	133,-
749	03->	091323 RG4HC	124,-	155,-
748R LC	03->	091345 QA55V	177,-	221,-
748S LC	00->	091322 RA59GC	106,-	133,-
Biposto 4-stroke/SPS	95->	091322 RA59GC	106,-	133,-
Super Sport 748 4-stroke		091339 RA6HC	36,-	45,-
R, S 749	03->	091346 RG59V	164,-	205,-
749	02->	091323 RG4HC	124,-	155,-
Desmo Super Sport 750		091339 RA6HC	36,-	45,-
F1 4-stroke 750	85->	091339 RA6HC	36,-	45,-
F1 Formula 750 4-stroke		091347 L82YC	30,-	38,-
GT 750		091312 RL82YC	36,-	45,-
Indiana 750		091312 RL82YC	36,-	45,-
Laguna Seca 750		091339 RA6HC	36,-	45,-
LS 750	85->	091339 RA6HC	36,-	45,-
Monster AC 750 4-stroke		091339 RA6HC	36,-	45,-
Montjuichi 750 4-stroke		091339 RA6HC	36,-	45,-
Montjuichi U 750		091306 RA8HC	38,-	48,-
Paso 750 4-stroke	86-92	091339 RA6HC	36,-	45,-
S 750		091312 RL82YC	36,-	45,-
Santa Monica 750		091339 RA6HC	36,-	45,-
SS 750		091312 RL82YC	36,-	45,-
SS Special AC 750	92->	091322 RA59GC	106,-	133,-
SS Super Sport 750		091347 L82YC	30,-	38,-
Strada 750		091347 L82YC	30,-	38,-
Supersport 4-stroke 750		091339 RA6HC	36,-	45,-
Monster S2 R 800	07->	091326 RA4HC	50,-	63,-
800 Sport i.e. HF 802	03->	091326 RA4HC	50,-	63,-
800 Sport i.e./SS/HF 802	03->	091326 RA4HC	50,-	63,-
i.e. 851		091348 A59GC	162,-	203,-
SP 851 Sport Production		091349 A59C	140,-	175,-
Superbike 851 4-stroke		091349 A59C	140,-	175,-
Superbike 851 Strada 4-str.		091349 A59C	140,-	175,-
Superbike 851 Vers. Kit 4-str.		091345 QA55V	177,-	221,-
SS Desmo 860/GT/GTS		091342 L86C	28,-	35,-
Damah 900 SS, SD, GT, GTS		091312 RL82YC	36,-	45,-
Mike Hallwood Replica 864		091342 L86C	28,-	35,-
Replica 900, S, S2 864		091312 RL82YC	36,-	45,-
SS 900 864		091347 L82YC	30,-	38,-
SP1 888	89-94	091345 QA55V	177,-	221,-
SP5 888		091345 QA55V	177,-	221,-
Strada 888		091348 A59GC	162,-	203,-
Supersport 888 4-stroke		091348 A59GC	162,-	203,-
Darmah 900		091347 L82YC	30,-	38,-
Monster City, S, C AC 900		091339 RA6HC	36,-	45,-
Superlight 900		091339 RA6HC	36,-	45,-
Supersport SS Europa 900		091306 RA8HC	38,-	48,-
Supersport USA 900 Svizzera		091339 RA6HC	36,-	45,-
900 SS 4-stroke		091339 RA6HC	36,-	45,-
MH900E AC	00->	091339 RA6HC	36,-	45,-
Paso Super 904/Super Sport		091339 RA6HC	36,-	45,-
Superlight 904 4-stroke		091339 RA6HC	36,-	45,-
Paso 906 4-stroke		091326 RA4HC	50,-	63,-
i.e. 907 4-stroke		091326 RA4HC	50,-	63,-
Racing 916		091322 RA59GC	106,-	133,-
S4 Monster 916	01->	091322 RA59GC	106,-	133,-
Senna 916	95->	091322 RA59GC	106,-	133,-
SP 916/Sport Production 4-st.		091345 QA55V	177,-	221,-
SPS 916	94->	091322 RA59GC	106,-	133,-
ST4 916	98->	091322 RA59GC	106,-	133,-
ST2 LC 4-stroke 944	97->	091326 RA4HC	50,-	63,-
ST2 944	03->	091326 RA4HC	50,-	63,-
Racing 950	95->	091345 QA55V	177,-	221,-
Mille S2, Replica 972		091312 RL82YC	36,-	45,-
1000 SS i.e. 992/DS	03->	091339 RA6HC	36,-	45,-

- Stikord Sökord s. 2-5
- Forhandlere Aterforsäljare s. 6-9
- Tøj/hjelme Klæder/hjälmar s. 11
- Dæk Däck s. 83
- Olje Olja s. 115
- Kæde/tandhjul Kedjor/drev s. 145
- Bremser Broms s. 187
- Låse Lås s. 347
- Batteri Batterier s. 355
- Pakninger Packningar s. 377
- Motordele Motordelar s. 411
- Lejer Lager s. 435
- Karburator Förgasare s. 467
- El-dele/Tænding Elektriskt/Tänding s. 509
- Blinklygter Baglygter Belysning Baklykter s. 611
- Lyddæmper Avgassystem s. 651
- Støddæmper Støtdämpare s. 681
- Luft-/oliefilter Luft-/oljefilter s. 711
- Kobling Koppling s. 769
- Kabler Wire s. 803
- Styr/greb Styre/handtag s. 829
- Spejle og diverse Speglar och diverse s. 867
- Bøger/værktøj Böcker/verktøy s. 893

Tændrør til motorcykler Tändstift till motorcyklar

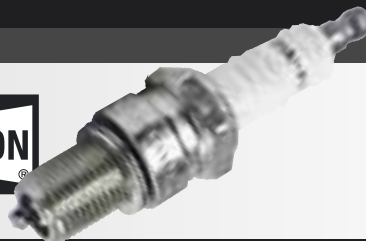

Mærke/ model	Prod. årg.	CHAMPION tændrør Varenr. Type		
Mærke/ modell	Prod. årg.	CHAMPION tændrør Art.nr. Type	DKK	SEK
DUCATI				
Monster 1000 i.e. 992	03->	091339 RA6HC	36,-	45,-
Multistrada 992	03->	091339 RA6HC	36,-	45,-
Paul Smart 1000	05->	091339 RA6HC	36,-	45,-
S2R 1000 992		091339 RA6HC	36,-	45,-
ST2 992	04->	091339 RA6HC	36,-	45,-
ST3 992	04->			
996 LC	00->	091322 RA59GC	106,-	133,-
996 SPS	97->	091345 QA55V	177,-	221,-
ST4 S 996	03->	091322 RA59GC	106,-	133,-
ST4 S ABS 996	03->	091322 RA59GC	106,-	133,-
998	03->	091323 RG4HC	124,-	155,-
999 R 998	03->	091346 RG59V	164,-	205,-
999 S 998	03->	091323 RG4HC	124,-	155,-
Monster S4 R 998	07->	091323 RG4HC	124,-	155,-
Monster S4 RS 998	07->	091323 RG4HC	124,-	155,-
GT 1000	07->	091326 RA4HC	50,-	63,-
Monster S2 R 1000	07->	091326 RA4HC	50,-	63,-
Sport 1000 / S	07->	091326 RA4HC	50,-	63,-
Hypermotard 1100	07->	091326 RA4HC	50,-	63,-
Multistrada 1100 / S	07->	091326 RA4HC	50,-	63,-

ENFIELD				
KB 100		091350 N2C	28,-	35,-
Scooter 125		091342 L86C	28,-	35,-
De-Luxe Culot long 305		091319 RN5C	36,-	45,-
Bullet 350 u. 12,7mm		091336 RL82C	36,-	45,-
De-Luxe Culot court 350		091361 RL86C	38,-	48,-
Bullet 500 u. 19mm		091319 RN5C	36,-	45,-
Interceptor 750		091351 RN4C	38,-	48,-

HARLEY DAVIDSON				
Servicar G SV	34-73	091305 D14	42,-	53,-
W SV 750	37-51	091305 D14	42,-	53,-
WL SV 750	37-51	091305 D14	42,-	53,-
WLA SV 750	41-44	091305 D14	42,-	53,-
WLC SV 750	41-44	091305 D14	42,-	53,-
WLD SV 750	37-51	091305 D14	42,-	53,-
Sportster Custom 883				
XL53D Evolution	00->	091306 RA8HC	38,-	48,-
Sportster Hugger XLH 883	85->	091310 RAX96YC	42,-	53,-
Sportster XLH 883	94->	091310 RAX96YC	42,-	53,-
Sportster XL, SLH, SLCH 900	57-71	091311 H8C	38,-	48,-
Café Racer XLCR 1000	77-79	091311 H8C	38,-	48,-
F IOE 1000/J IOE 1000	14-29	091305 D14	42,-	53,-
F IOE 1000/J IOE 1000	14-29	091307 W14	161,-	201,-
Knucklehead E, EL 1000	36-47	091305 D14	42,-	53,-
Panhead E, EL 1000	48-52	091308 J12YC	30,-	38,-
Sportster XLH, XLCH, XLS 1000	80-85	091312 RL82YC	36,-	45,-
Sportster XLH, SLCH, XLS, XLX 1000	71-79	091311 H8C	38,-	48,-
XR 1000	83-85	091353 RN7YC	36,-	45,-
Evolution 1100	86->	091310 RAX96YC	42,-	53,-
Evolution Sportster				
XLC Custom 1200	87->	091306 RA8HC	38,-	48,-
FD IOE 1200/JD IOE/JDH IOE	22-26	091307 W14	161,-	201,-
FD IOE 1200/JD IOE/JDH IOE	27-29	091305 D14	42,-	53,-
Knucklehead 1200 F, FL	41-47	091305 D14	42,-	53,-
Panhead 1200 F, FL, FLH, FLHF	48-65	091308 J12YC	30,-	38,-
Shovelhead 1200 FL, FLH, FLP, FX	75-79	091304 RN12YC	38,-	48,-
Shovelhead 1200 FL, FLH, FX	66-74	091308 J12YC	30,-	38,-
Sportster 1200 XL S, XL C	96->	091310 RAX96YC	42,-	53,-
U SV 1200 /UL SV	37-48	091305 D14	42,-	53,-
V SV/VD/VL /VLD 1200	30-36	091305 D14	42,-	53,-
UH SV 1300/ULH/VLH	31-41	091305 D14	42,-	53,-
Bad Boy FXSTSB AC 1340	85->	091304 RN12YC	38,-	48,-
Dyna 1340 FXDS AC Conve.	85->	091304 RN12YC	38,-	48,-
Dyna 1340 Low Rider FXDL	85->	091304 RN12YC	38,-	48,-
Dyna 1340 Super Glide FXD	85->	091304 RN12YC	38,-	48,-
Dyna 1340 Wide Glide				
FXDWG AC V-Twin	85->	091304 RN12YC	38,-	48,-
Electra 1340 Glide Classic				
FLHTC AC V-Twin	84->	091304 RN12YC	38,-	48,-

Mærke/ model	Prod. årg.	CHAMPION tændrør Varenr. Type		
Mærke/ modell	Prod. årg.	CHAMPION tændrør Art.nr. Type	DKK	SEK
HARLEY DAVIDSON				
Electra 1340 Glide FLHT AC	84->	091304 RN12YC	38,-	48,-
Evolution 1340 FL, FX	84->	091304 RN12YC	38,-	48,-
Fat Boy FLSTF 1340 AC	84->	091304 RN12YC	38,-	48,-
Road King 1340 FLHR AC	84->	091304 RN12YC	38,-	48,-
Road King 1340 FLHRI AC	84->	091304 RN12YC	38,-	48,-
Shovelhead 1340	78-79	091304 RN12YC	38,-	48,-
Shovelhead 1340 FL, FX alle	80-84	091304 RN12YC	38,-	48,-
Softtail 1340 Classic FLSTC	84->	091304 RN12YC	38,-	48,-
Softtail 1340 Custom FLSTN	84->	091304 RN12YC	38,-	48,-
Softtail 1340 Special FLSTN	84->	091304 RN12YC	38,-	48,-
Springer 1340 Softtail FXSTS	85->	091304 RN12YC	38,-	48,-
Ultra 1340 Classic FLHTCU	84->	091304 RN12YC	38,-	48,-
Dyna 1450 Low Rider FXDL	00->	091306 RA8HC	38,-	48,-
Dyna 1450 Super Glide FXD	99->	091306 RA8HC	38,-	48,-
Dyna 1450 Super Glide Sport				
FXDX AC Twin Cam 88	00->	091306 RA8HC	38,-	48,-
Dyna 1450 Super Glide				
T Sport FXDX AC Twin Cam	00->	091306 RA8HC	38,-	48,-
Dyna 1450 Wide Glide				
FXDWG Twin Cam	00->	091306 RA8HC	38,-	48,-
Electra 1450 Glide Standard				
FLHT Twin Cam 88	00->	091306 RA8HC	38,-	48,-
Electra 1450 Glide Ultra				
FLHTCUI Twin Cam 88	00->	091306 RA8HC	38,-	48,-
Fat Boy 1450 FLSTF, FLSTFI Twin Cam 88	00->	091306 RA8HC	38,-	48,-
Heritage 1450 Softtail Classic				
FLSTC, FLSTCI Twin Cam 88	00->	091306 RA8HC	38,-	48,-
Heritage 1450 Springer				
FLSTS Twin Cam 88	00->	091306 RA8HC	38,-	48,-
Night Train 1450				
FXSTB Twin Cam 88	00->	091306 RA8HC	38,-	48,-
Road Glide 1450				
FLTRI Twin Cam 88	00->	091306 RA8HC	38,-	48,-
Road King 1450 Classic				
FLHRCI Twin Cam 88	00->	091306 RA8HC	38,-	48,-
Road King 1450				
FLHR Twin Cam 88	00->	091306 RA8HC	38,-	48,-
Softtail Deuce 1450 FXSTD, FXSTDI AC Twin Cam 88	00->	091306 RA8HC	38,-	48,-
Softtail Standard 1450				
FXST Twin Cam 88	00->	091306 RA8HC	38,-	48,-
Springer Softtail 1450				
FXSTS Twin Cam 88	00->	091306 RA8HC	38,-	48,-

HUSABERG				
MC, Cross, Enduro, FE, FC Elduro 350		091315 RG94C	92,-	115,-
FC 400		091354 G59C	156,-	195,-
FE, E, S 400		091354 G59C	156,-	195,-
FX E 400		091354 G59C	156,-	195,-
Quad 400		091354 G59C	156,-	195,-
FC 470	00->	091339 RA6HC	36,-	45,-
FX 470 E	00->	091339 RA6HC	36,-	45,-
FE 501 E 500	00->	091339 RA6HC	36,-	45,-
MC 501, Cross, Enduro, FE, FC, Elduro 500		091315 RG94C	92,-	115,-
FC 550	00->	091339 RA6HC	36,-	45,-
MC, Cross, Enduro, FE, FC, Elduro 600		091315 RG94C	92,-	115,-
FE 650 E	00->	091339 RA6HC	36,-	45,-
FS 650 E/C	00->	091339 RA6HC	36,-	45,-
FX 650 E	00->	091339 RA6HC	36,-	45,-

HUSOVARNA				
Air cooled 125		091325 RN2C	36,-	45,-
CR Cross 2-stroke 125		091324 QN84	136,-	170,-
Motocross 125		091324 QN84	136,-	170,-
SM 2-stroke 125		091324 QN84	136,-	170,-
WR Enduro 2-stroke 125		091324 QN84	136,-	170,-
WRE Enduro 2-stroke 125		091324 QN84	136,-	170,-
WRK 125		091324 QN84	136,-	170,-
CR 240		091324 QN84	136,-	170,-
RC 240		091324 QN84	136,-	170,-
WR 240		091324 QN84	136,-	170,-

Tændrør til motorcykler
Tändstift till motorcyklar



Mærke/ model	Prod. årg.	CHAMPION tændrør Varenr. Type	DKK	SEK
Märke/ modell	Prod. årg.	CHAMPION tändrør Art.nr. Type	DKK	SEK
HUSQVARNA				
WRE 240		091324 QN84	136,-	170:-
WRK 240		091324 QN84	136,-	170:-
Air cooled 250		091325 RN2C	36,-	45:-
CR 250	00->	091355 QC59	184,-	230:-
Motocross 250		091324 QN84	136,-	170:-
WR Enduro 2-stroke 250		091324 QN84	136,-	170:-
WRK 250		091324 QN84	136,-	170:-
WR 260		091356 C55	103,-	129:-
TE, WXC 350		091354 G59C	156,-	195:-
Cross 360		091324 QN84	136,-	170:-
WR Enduro 360		091324 QN84	136,-	170:-
Air cooled 390		091325 RN2C	36,-	45:-
MX 400		091350 N2C	28,-	35:-
SMR 400 R	01->	091354 G59C	156,-	195:-
TE 400	00->	091329 RG96C	136,-	170:-
TE 400 R	01->	091354 G59C	156,-	195:-
WR 400		091358 QN86	135,-	169:-
TE 410	95->	091329 RG96C	136,-	170:-
TE 2A, A 410	96->	091329 RG96C	136,-	170:-
TE 410 Enduro 4-stroke 414		091354 G59C	156,-	195:-
Air cooled 420		091325 RN2C	36,-	45:-
Air cooled 430		091325 RN2C	36,-	45:-
Air cooled 450		091325 RN2C	36,-	45:-
Air cooled 500		091325 RN2C	36,-	45:-
TC air cooled 500		091334 8809	54,-	68:-
TE air cooled 500		091334 8809	54,-	68:-
TX air cooled 500		091334 8809	54,-	68:-
AC 510		091334 8809	54,-	68:-
Huski 510	87->	091329 RG96C	136,-	170:-
TC 510	87->	091329 RG96C	136,-	170:-
TC 500 air cooled 510		091334 8809	54,-	68:-
TE air cooled 510		091334 8809	54,-	68:-
TE 510	87->	091329 RG96C	136,-	170:-
TE AC 510		091334 8809	54,-	68:-
TX air cooled 510		091334 8809	54,-	68:-
SM R 570	99->	091329 RG96C	136,-	170:-
TC 570	00->	091329 RG96C	136,-	170:-
TE 570	00->	091329 RG96C	136,-	170:-
LT 610 4-stroke 577		091354 G59C	156,-	195:-
SM 610 4-stroke 577		091354 G59C	156,-	195:-
TC 610 4-stroke 577		091354 G59C	156,-	195:-
TE 610 E 4-stroke 577		091354 G59C	156,-	195:-
TEE 610 Enduro 4-stroke 577		091354 G59C	156,-	195:-
TE 610, Cross, TC, WXC 580		091354 G59C	156,-	195:-
SM R 610	99->	091315 RG94C	92,-	115:-
SM S 610	99->	091329 RG96C	136,-	170:-
TC 610		091354 G59C	156,-	195:-
TE Cross TC, WXC 610	91->	091329 RG96C	136,-	170:-
TE E 610	99->	091329 RG96C	136,-	170:-

Mærke/ model	Prod. årg.	CHAMPION tændrør Varenr. Type	DKK	SEK
Märke/ modell	Prod. årg.	CHAMPION tändrør Art.nr. Type	DKK	SEK
JAWA/CZ				
CZ 125		091336 RL82C	36,-	45:-
Grand Prix 125		091341 QL55	150,-	188:-
Moto-Cross 125		091341 QL55	150,-	188:-
Roadster 125		091336 RL82C	36,-	45:-
CZ 175		091336 RL82C	36,-	45:-
Enduro 175	77->	091361 RL86C	38,-	48:-
Sport 175		091336 RL82C	36,-	45:-
Trail 175		091336 RL82C	36,-	45:-
Calif III 250		091344 L78C	36,-	45:-
Custom Spts. Roadst. 250		091361 RL86C	38,-	48:-
Deluxe 250		091361 RL86C	38,-	48:-
Enduro 250		091344 L78C	36,-	45:-
Grand Pris 250		091341 QL55	150,-	188:-
I.S.D.T. 250	77->	091341 QL55	150,-	188:-
Moto-Cross 250		091341 QL55	150,-	188:-
MX 250	77->	091341 QL55	150,-	188:-
634 Series 350		091344 L78C	36,-	45:-
638 Series 350		091344 L78C	36,-	45:-
Calif III 350		091344 L78C	36,-	45:-
Calif IV 350		091344 L78C	36,-	45:-
CZ 350		091344 L78C	36,-	45:-
De-Luxe 350		091344 L78C	36,-	45:-
I.S.D.T. 350	77->	091341 QL55	150,-	188:-

Mærke/ model	Prod. årg.	CHAMPION tændrør Varenr. Type	DKK	SEK
Märke/ modell	Prod. årg.	CHAMPION tändrør Art.nr. Type	DKK	SEK
JAWA/CZ				
Javelin 350		091344 L78C	36,-	45:-
Javelin Super 350		091344 L78C	36,-	45:-
Shadow Sport 350		091344 L78C	36,-	45:-
Super Sport 350		091344 L78C	36,-	45:-
Tradesman 350		091344 L78C	36,-	45:-
TS 350	77->	091344 L78C	36,-	45:-
Velorex 350		091344 L78C	36,-	45:-
Moto-Cross 360		091341 QL55	150,-	188:-
Grand Prix 400		091341 QL55	150,-	188:-
Moto-Cross 400		091341 QL55	150,-	188:-
884 Speedway 500		091362 G57R	322,-	403:-
890 Iceracing Pushrod 500		091363 C55R	351,-	439:-
890 Longtrack 500		091363 C55R	351,-	439:-
890 Longtrack Pushrod 500		091363 C55R	351,-	439:-
890 Speedway Pushrod 500		091363 C55R	351,-	439:-
891 Iceracing 500		091363 C55R	351,-	439:-
892 Iceracing Pushrod 500		091363 C55R	351,-	439:-
892 Longtrack Pushrod 500		091363 C55R	351,-	439:-
892 Speedway Pushrod 500		091363 C55R	351,-	439:-
893 Iceracing 500		091363 C55R	351,-	439:-
893-7 Iceracing 500		091363 C55R	351,-	439:-
894 Speedway 500		091363 C55R	351,-	439:-
895 Longtrack 500		091363 C55R	351,-	439:-
895 Speedway 500		091363 C55R	351,-	439:-
896 Longtrack 500		091343 G55R	297,-	371:-
897 Speedway 500		091362 G57R	322,-	403:-
898 Speedway 500		091362 G57R	322,-	403:-

Mærke/ model	Prod. årg.	CHAMPION tændrør Varenr. Type	DKK	SEK
Märke/ modell	Prod. årg.	CHAMPION tändrør Art.nr. Type	DKK	SEK
LAVERDA				
CR Cruiser 600		091339 RA6HC	36,-	45:-
OR Atlas 600		091339 RA6HC	36,-	45:-
Bicilindrico 650		091326 RA4HC	50,-	63:-
Formula 650	96->	091326 RA4HC	50,-	63:-
Ghost 650	95->	091326 RA4HC	50,-	63:-
Lynx 650	00->	091315 RG94C	92,-	115:-
Sport 71 650	95->	091326 RA4HC	50,-	63:-
668 4-stroke 668		091322 RA59GC	106,-	133:-
668	96->	091326 RA4HC	50,-	63:-
650 Ghost 4-stroke 668		091326 RA4HC	50,-	63:-
668 Ghost, Stryke 668 4-str.		091326 RA4HC	50,-	63:-
Hidalgo 668		091326 RA4HC	50,-	63:-
El Cid 700		091326 RA4HC	50,-	63:-
Diamond 750	97->	091326 RA4HC	50,-	63:-
Formula 750 LC 4-stroke		091326 RA4HC	50,-	63:-
GS 750		091325 RN2C	36,-	45:-
GT 750		091325 RN2C	36,-	45:-
S Formula 750 LC 2-stroke	98->	091326 RA4HC	50,-	63:-
S Formula S 750 Stryke 4-str.	98->	091322 RA59GC	106,-	133:-
SF 750		091325 RN2C	36,-	45:-
SFC 750		091363 C55R	351,-	439:-
Sport 750		091363 C55R	351,-	439:-
SS 750		091363 C55R	351,-	439:-
3C 1000	->82	091318 RN3C	36,-	45:-
3CE 1000	->82	091318 RN3C	36,-	45:-
3CL 1000	->82	091318 RN3C	36,-	45:-
Jota 1000	->82	091318 RN3C	36,-	45:-
RG 1000		091325 RN2C	36,-	45:-
RGA 1000		091325 RN2C	36,-	45:-
RGA Jota 1000		091325 RN2C	36,-	45:-
RGS 1000		091325 RN2C	36,-	45:-
SC 1000	->82	091318 RN3C	36,-	45:-
SFC 1000		091325 RN2C	36,-	45:-
Mirage 1200	->82	091318 RN3C	36,-	45:-
TS 1200	82->	091325 RN2C	36,-	45:-
TS 1200	->82	091318 RN3C	36,-	45:-

Mærke/ model	Prod. årg.	CHAMPION tændrør Varenr. Type	DKK	SEK
Märke/ modell	Prod. årg.	CHAMPION tändrør Art.nr. Type	DKK	SEK
MOTO GUZZI				
Florida 350		091314 N6YCC	40,-	50:-
GTS 350	74-80	091339 RA6HC	36,-	45:-
Nevada 350		091318 RN3C	36,-	45:-
NTX 350		091314 N6YCC	40,-	50:-
V35 350	79-86	091365 RZ94C	78,-	98:-
V35 Imola II 350		091314 N6YCC	40,-	50:-
GTS 400	75-80	091339 RA6HC	36,-	45:-
Imola 400		091314 N6YCC	40,-	50:-

- Stikord Sökord s. 2-5
- Forhandlere Aterforsäljare s. 6-9
- Tøj/hjelme Kläder/hjälmars s. 11
- Dæk Däck s. 83
- Olje Olja s. 115
- Kæde/tandhjul Kedjor/drev s. 145
- Bremser Broms s. 187
- Låse Lås s. 347
- Batteri Batterier s. 355
- Pakninger Packningar s. 377
- Motordele Motordelar s. 411
- Lejer Lager s. 435
- Karburator Förgasare s. 467
- El-dele/Tænding Elektriskt/Tänding s. 509
- Blinklygter Baglygter Belysning Baklykter s. 611
- Lyddæmper Avgassystem s. 651
- Støddæmper Støtdämpare s. 681
- Luft/oliefilter Luft/oljefilter s. 711
- Kobling Koppling s. 769
- Kabler Wire s. 803
- Styr/greb Styre/handtag s. 829
- Spejle og diverse Speglar och diverse s. 867
- Bøger/værktøj Böcker/verktyg s. 893

Tændrør til motorcykler
Tändstift till motorcyklar

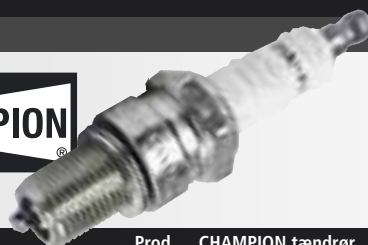

Mærke/ model	Prod. årg.	CHAMPION tændrør Varenr. Type		
Mærke/ modell	Prod. årg.	CHAMPION tændrør Art.nr. Type	DKK	SEK
MOTO GUZZI				
V40 400		091314 N6YCC	40,-	50,-
Ercole 500		091351 RN4C	38,-	48,-
Falcone 500		091351 RN4C	38,-	48,-
Falcone Nuovo 500		091351 RN4C	38,-	48,-
Sahara 500		091351 RN4C	38,-	48,-
V50 500	84-87	091365 RZ94C	78,-	98,-
V50 Monza II 500		091314 N6YCC	40,-	50,-
Florida 650		091314 N6YCC	40,-	50,-
GT 650		091314 N6YCC	40,-	50,-
NTX 650		091314 N6YCC	40,-	50,-
V 65 TT 650		091314 N6YCC	40,-	50,-
V65 650		091314 N6YCC	40,-	50,-
V65 C 650		091314 N6YCC	40,-	50,-
V65 Lario II 650	->86	091365 RZ94C	78,-	98,-
V65 SP 650		091314 N6YCC	40,-	50,-
V7 Special 700		091357 RN9YCC	41,-	51,-
V7 Sport 700		091357 RN9YCC	41,-	51,-
Dune 750		091318 RN3C	36,-	45,-
Nevada Base 750 AC 4-str.	00->	091300 N3C	28,-	35,-
Nevada Club 750 AC 4-str.		091318 RN3C	36,-	45,-
NTX V 750		091318 RN3C	36,-	45,-
S 750		091357 RN9YCC	41,-	51,-
SP 750		091318 RN3C	36,-	45,-
Targa 750		091318 RN3C	36,-	45,-
V75 750		091318 RN3C	36,-	45,-
V75 Duna 750		091366 RZ96C	80,-	100,-
California 850		091367 N9YC	28,-	35,-
Le Mans Mk II 850, Mk III		091357 RN9YCC	41,-	51,-
T3 850		091357 RN9YCC	41,-	51,-
T4 850		091357 RN9YCC	41,-	51,-
T5 California 850		091357 RN9YCC	41,-	51,-
California C i.e. 1000 GT, S		091314 N6YCC	40,-	50,-
Daytona 1000		091368 RAX92C	49,-	61,-
Daytona Injection 1000	96->	091368 RAX92C	49,-	61,-
Daytona RS 1000		091314 N6YCC	40,-	50,-
Le Mans IV 1000		091314 N6YCC	40,-	50,-
Quota i.e. 1000		091314 N6YCC	40,-	50,-
Strada 1000		091357 RN9YCC	41,-	51,-
V California III 1000		091357 RN9YCC	41,-	51,-
V California III Inj. 1000		091357 RN9YCC	41,-	51,-
V Convert 1000, SP, SP11, G5		091314 N6YCC	40,-	50,-
V CX 1000		091314 N6YCC	40,-	50,-
V 10 Centauro 1000 Injec.	96->	091368 RAX92C	49,-	61,-
California EV 1100	94->	091357 RN9YCC	41,-	51,-
California i 1100 AC 4-str.	00->	091369 RN9YC	32,-	40,-
California Jackal 1100 4-str.	00->	091357 RN9YCC	41,-	51,-
California Special 1100 AC	99->	091357 RN9YCC	41,-	51,-
Quota 1.15 1100 AC 4-str.		091357 RN9YCC	41,-	51,-
V11 Sport V Twin 1100 AC	98->	091369 RN9YC	32,-	40,-
V 75 i 1100	96->	091318 RN3C	36,-	45,-
MOTO MORINI				
31/2 350		091370 RN7YCC	42,-	53,-
31/2 Sport 350		091370 RN7YCC	42,-	53,-
Coguardo 350		091370 RN7YCC	42,-	53,-
Country 350		091370 RN7YCC	42,-	53,-
Dart 350		091370 RN7YCC	42,-	53,-
Excalibur 350 2-stroke		091370 RN7YCC	42,-	53,-
K2 350		091370 RN7YCC	42,-	53,-
Kanguro 350		091370 RN7YCC	42,-	53,-
Kanguro XE 350		091370 RN7YCC	42,-	53,-
New York 350		091370 RN7YCC	42,-	53,-
Strada 350		091370 RN7YCC	42,-	53,-
Dart 400	91->	091370 RN7YCC	42,-	53,-
2 cyl. mot. 500	82->	091370 RN7YCC	42,-	53,-
Camel 500	->82	091370 RN7YCC	42,-	53,-
Camel 501, XE		091370 RN7YCC	42,-	53,-
Coguardo 501		091370 RN7YCC	42,-	53,-
Excalibur 501 2-stroke	91->	091370 RN7YCC	42,-	53,-
New York 501	91->	091370 RN7YCC	42,-	53,-
MUZ				
Moskito 50	97->	091336 RL82C	36,-	45,-
Roadster 125		091303 L82C	28,-	35,-
RT 125 4-stroke	00->	091315 RG94C	92,-	115,-

Mærke/ model	Prod. årg.	CHAMPION tændrør Varenr. Type		
Mærke/ modell	Prod. årg.	CHAMPION tændrør Art.nr. Type	DKK	SEK
MUZ				
Sportstar 125	93->	091303 L82C	28,-	35,-
Tour 125	94->	091303 L82C	28,-	35,-
Saxon Country Rotax 500	93->	091334 8809	54,-	68,-
Saxon Fun Rotax 500	93->	091334 8809	54,-	68,-
Saxon Tour Rotax 500	91->	091334 8809	54,-	68,-
Saxon Voyager Rotax 500	93->	091334 8809	54,-	68,-
Silver Star 500 Classic Rotax	93->	091334 8809	54,-	68,-
Baghira Standard 660	97->	091334 8809	54,-	68,-
Baghira Fast Riding 660	97->	091316 RAX92YC	42,-	53,-
Mastiff Standard 660	97->	091334 8809	54,-	68,-
Mastiff Fast Riding 660	97->	091316 RAX92YC	42,-	53,-
Skorpion Replica 660 3YF	95->	091316 RAX92YC	42,-	53,-
Skorpion Sport 3YF 660	94->	091316 RAX92YC	42,-	53,-
Skorpion Touring 660,				
Traveller 3YF	94->	091316 RAX92YC	42,-	53,-
Kobra 850 3VD	95->	091334 8809	54,-	68,-
MV AGUSTA				
F4 Ago 750	03->	091333 G54V	355,-	444,-
F4 Brutale S 750	02->	091315 RG94C	92,-	115,-
F4 S 750	03->	091333 G54V	355,-	444,-
F4 S 1+1 750	03->	091333 G54V	355,-	444,-
F4 SPR 750	03->	091333 G54V	355,-	444,-
S4 750	98->	091315 RG94C	92,-	115,-
Brutale 910 R 909	06->	091354 G59C	156,-	195,-
Brutale 910 S 909	05->	091354 G59C	156,-	195,-
F4 1000 1+1 1000	05->	091333 G54V	355,-	444,-
F4 1000 S	04->	091323 RG4HC	124,-	155,-
F4 1000 Senna	06->	091333 G54V	355,-	444,-
F4 1000 Tamburini	04-05	091323 RG4HC	124,-	155,-
MZ (MUZ)				
ES 1 Trophy 125		091336 RL82C	36,-	45,-
ETZ 125		091336 RL82C	36,-	45,-
Luxus 125		091336 RL82C	36,-	45,-
Saxon Roadstar 125	93->	091344 L78C	36,-	45,-
Saxon Sportster 125	93->	091344 L78C	36,-	45,-
TS Alpine 125		091336 RL82C	36,-	45,-
ES 1 Trophy, Super 150		091336 RL82C	36,-	45,-
ETS, Trophy-Sport 150		091344 L78C	36,-	45,-
TS, Eagle, Sport 150		091344 L78C	36,-	45,-
ES 2 Trophy 175		091344 L78C	36,-	45,-
ES2 502 Trophy 250		091336 RL82C	36,-	45,-
ES2 502 Trophy Deluxe 250		091336 RL82C	36,-	45,-
ETS I.G. 250		091344 L78C	36,-	45,-
ETS Trophy-Sport 250		091344 L78C	36,-	45,-
ETZ 250		091336 RL82C	36,-	45,-
TS Sport 250		091344 L78C	36,-	45,-
TS2 501 Supa 5 250		091344 L78C	36,-	45,-
ETZ 301	90->	091344 L78C	36,-	45,-
MZ 500		091339 RA6HC	36,-	45,-
Baghira 660	97->	091316 RAX92YC	42,-	53,-
Baghira City Driving 660	97->			
Mastiff 660	97->	091316 RAX92YC	42,-	53,-
Mastiff City Driving 660	97->			
Skorpion 660	94->	091316 RAX92YC	42,-	53,-
Kobra 850	95->			
NORTON				
Dominator 7 500 Alum head		091302 N5C	30,-	38,-
Dominator 500 7 Iron head		091303 L82C	28,-	35,-
Dominator 500 88 Alum h.		091302 N5C	30,-	38,-
Dominator 500 88 iron head		091303 L82C	28,-	35,-
ES2 500		091302 N5C	30,-	38,-
ES2 Iron head 500		091303 L82C	28,-	35,-
F1 588 LC Rotary engine		091315 RG94C	92,-	115,-
Dominator 600		091302 N5C	30,-	38,-
Dominator 600 99 Alum h.		091302 N5C	30,-	38,-
Manxman 650		091372 N7YC	36,-	45,-
Mercury 650		091372 N7YC	36,-	45,-
Atlas 745		091314 N6YCC	40,-	50,-
Ranger P11A 745		091314 N6YCC	40,-	50,-
Commando 750 Fastback				
Hard Driving		091314 N6YCC	40,-	50,-
Commando Fastback 750		091372 N7YC	36,-	45,-

Tændrør til motorcykler
Tändstift till motorcyklar



Mærke/ model	Prod. årg.	CHAMPION tændrør Varenr. Type		
Mærke/ modell	Prod. årg.	CHAMPION tændrør Art.nr. Type	DKK	SEK
NORTON				
Commando S 750				
Roadster Hard Driving		091314 N6YCC	40,-	50,-
Commando S 750 Roadster		091372 N7YC	36,-	45,-
Commando 850		091372 N7YC	36,-	45,-
G15 850		091372 N7YC	36,-	45,-
P11 850		091372 N7YC	36,-	45,-
Ranger 850		091372 N7YC	36,-	45,-

PIAGGIO				
Mærke/ model	Prod. årg.	CHAMPION tændrør Varenr. Type	DKK	SEK
Liberty 125 4-stroke	98->	091323 RG4HC	124,-	155,-
Vespa GT L i 125	03->	091323 RG4HC	124,-	155,-
Liberty 4T 150 Leader 4-str.	98->	091373 RRG6YC	92,-	115,-
Hexagon LXT 180 2-stroke	98->	091325 RN2C	36,-	45,-
Hexagon Super GTX 182 4-s	00->	091323 RG4HC	124,-	155,-
X9 200 Evolution 198	03->	091327 RG6YC	80,-	100,-
Vespa GT L i 200	03->	091327 RG6YC	80,-	100,-
Hexagon 250	98->	091306 RA8HC	38,-	48,-
X9 250	00->	091339 RA6HC	36,-	45,-
Beverly 500 460	03->	091327 RG6YC	80,-	100,-
X9 500 4V i.e. Evolution 460	03->	091327 RG6YC	80,-	100,-

PIAGGIO (MOTO VESPA)				
Mærke/ model	Prod. årg.	CHAMPION tændrør Varenr. Type	DKK	SEK
Cosa 125		091325 RN2C	36,-	45,-
Cosa 125		091350 N2C	28,-	35,-
ET3 125		091336 RL82C	36,-	45,-
GTR 125		091342 L86C	28,-	35,-
Hexagon 125	01->			
Hexagon 125 4T 2-stroke		091350 N2C	28,-	35,-
Hexagon 125 4T H2O 2-str.		091325 RN2C	36,-	45,-
Hexagon 125 LX 4-stroke		091327 RG6YC	80,-	100,-
Hexagon 125 Super GTX LX				
4T 4-stroke		091323 RG4HC	124,-	155,-
LX2 125	97->	091350 N2C	28,-	35,-
LX4 125	98->	091329 RG96C	136,-	170,-
P ETS 125		091342 L86C	28,-	35,-
P X 125		091336 RL82C	36,-	45,-
PK 125		091336 RL82C	36,-	45,-
PK Automatica 125		091336 RL82C	36,-	45,-
PK E 125		091336 RL82C	36,-	45,-
PK S 125	->83	091342 L86C	28,-	35,-
PK S 125	84->	091336 RL82C	36,-	45,-
Primavera 125		091336 RL82C	36,-	45,-
PX E 125		091336 RL82C	36,-	45,-
PX FL 125 2-stroke		091336 RL82C	36,-	45,-
Sfera 125 scooter 4-stroke	95->	091323 RG4HC	124,-	155,-
Skipper 125 4-stroke		091327 RG6YC	80,-	100,-
Skipper 125 4T Leader 2-str.		091325 RN2C	36,-	45,-
Skipper 125 LX 2-stroke		091325 RN2C	36,-	45,-
Super 125		091342 L86C	28,-	35,-
TS 125		091342 L86C	28,-	35,-
Typhoon scooter 125	95->	091325 RN2C	36,-	45,-
Vespa ET4 125 scooter 4-str.	96->	091323 RG4HC	124,-	155,-
Vespa FL 125 2-stroke		091344 L78C	36,-	45,-
Vespa P125CL 125	->83	091342 L86C	28,-	35,-
Vespa T5 125		091325 RN2C	36,-	45,-
X-9 125	01->	091335 8654	67,-	84,-
XL Plurimat Elestart 125		091303 L82C	28,-	35,-
Cosa 150		091325 RN2C	36,-	45,-
Hexagon 150 2-stroke		091350 N2C	28,-	35,-
P S 150		091342 L86C	28,-	35,-
P X 150		091342 L86C	28,-	35,-
Piaggio 150		091350 N2C	28,-	35,-
PX E 150		091342 L86C	28,-	35,-
PX FL 150 2-stroke		091336 RL82C	36,-	45,-
Skipper 150 4-stroke		091327 RG6YC	80,-	100,-
Skipper 4T 150 Leader 2-str.		091325 RN2C	36,-	45,-
Skipper LXT 150 2-stroke		091325 RN2C	36,-	45,-
Vespa Spring 150				
Veloce, Super		091342 L86C	28,-	35,-
Vespa 175		091342 L86C	28,-	35,-
Hexagon Super GTX 180	01->	091335 8654	67,-	84,-
Cosa 200		091318 RN3C	36,-	45,-
DN 200		091351 RN4C	38,-	48,-
DS 200		091351 RN4C	38,-	48,-
PE Lusso 200		091351 RN4C	38,-	48,-

Mærke/ model	Prod. årg.	CHAMPION tændrør Varenr. Type		
Mærke/ modell	Prod. årg.	CHAMPION tændrør Art.nr. Type	DKK	SEK
PIAGGIO (MOTO VESPA)				
PX E 200		091351 RN4C	38,-	48,-
PX FL 200 2-stroke		091351 RN4C	38,-	48,-
Vespa Rally 200		091351 RN4C	38,-	48,-
Ape TM 220 2-stroke		091375 RL78C	38,-	48,-
X-9 Honda 250	00->	091310 RAX96YC	42,-	53,-
Ape Poker 422 4-stroke		091376 RC7BYC4	57,-	71,-
Porter 998 4-stroke		091369 RN9YC	32,-	40,-
Porter 998		091369 RN9YC	32,-	40,-

TRIUMPH				
Mærke/ model	Prod. årg.	CHAMPION tændrør Varenr. Type	DKK	SEK
Tiger Cub T20 model 200		091336 RL82C	36,-	45,-
Trophy 250		091318 RN3C	36,-	45,-
Adventurer 500		091318 RN3C	36,-	45,-
Daytona T100 500		091318 RN3C	36,-	45,-
TR5 MX 500		091318 RN3C	36,-	45,-
TR5 T 500		091318 RN3C	36,-	45,-
Trophy 500		091318 RN3C	36,-	45,-
TT LC 600	99->	091340 RG92DC	84,-	105,-
Bonneville T120 650		091318 RN3C	36,-	45,-
Thunderbird TR65 650		091318 RN3C	36,-	45,-
Tiger 650		091318 RN3C	36,-	45,-
Trophy TR6 650		091318 RN3C	36,-	45,-
Bonneville T140V 750		091318 RN3C	36,-	45,-
Daytona 750	91->	091316 RAX92YC	42,-	53,-
Hurricane TRX 75 750	73-78	091300 N3C	28,-	35,-
Speed Triple 750 Sports				
Traverse LC 4-stroke		091326 RA4HC	50,-	63,-
T 140 E, D 750		091319 RN5C	36,-	45,-
T 160 750		091318 RN3C	36,-	45,-
Tiger TR7RV 750		091318 RN3C	36,-	45,-
TR7T 750		091318 RN3C	36,-	45,-
TR7V 750		091318 RN3C	36,-	45,-
Tridens 750		091318 RN3C	36,-	45,-
Trident T150V 750	91->	091316 RAX92YC	42,-	53,-
Triumph TSS Twin 750		091320 G63	173,-	216,-
Bonneville 790 AC	00->			
Adventurer 885 LC	00->			
Legend TT 885 LC	99->			
Thunderbird 885 LC	00->	091316 RAX92YC	42,-	53,-
Adventurer 900	96->	091316 RAX92YC	42,-	53,-
Daytona 900	91->	091316 RAX92YC	42,-	53,-
Daytona Super III 900	94->	091316 RAX92YC	42,-	53,-
Legend TT 900	00->			
Speed Triple Injection 900	96->			
Speed Triple T509 900	94->	091316 RAX92YC	42,-	53,-
Sprint 900	95->	091316 RAX92YC	42,-	53,-
Thunderbird Classic 900	95->	091316 RAX92YC	42,-	53,-
Tiger 900	93->	091316 RAX92YC	42,-	53,-
Trident 900	91->	091326 RA4HC	50,-	63,-
Trident Sprint 900	93->	091316 RAX92YC	42,-	53,-
Trophy 900 LC	91->	091316 RAX92YC	42,-	53,-
Daytona T595 955				
Super III Injection LC	96->			
Speed Triple 955 LC	99->	091316 RAX92YC	42,-	53,-
Sprint RS 955 LC	00->	091316 RAX92YC	42,-	53,-
Sprint ST 955 LC	99->	091316 RAX92YC	42,-	53,-
Tiger 955 LC	00->			
Daytona 1000	91-93	091316 RAX92YC	42,-	53,-
Daytona 1200	93->	091316 RAX92YC	42,-	53,-
Thunderbird 1200	95->	091316 RAX92YC	42,-	53,-
Tiger 1200	92->	091316 RAX92YC	42,-	53,-
Trophy 1200 LC	91->	091316 RAX92YC	42,-	53,-

- Stikord Sökord s. 2-5
- Forhandlere Aterforsäljare s. 6-9
- Tøj/hjelme Klæder/hjälmar s. 11
- Dæk Däck s. 83
- Olje Olja s. 115
- Kæde/tandhjul Kedjor/drev s. 145
- Bremser Broms s. 187
- Låse Lås s. 347
- Batteri Batterier s. 355
- Pakninger Packningar s. 377
- Motordele Motordelar s. 411
- Lejer Lager s. 435
- Karburator Förgasare s. 467
- El-dele/Tænding Elektriskt/Tänding s. 509
- Blinklygter Baglygter Belysning Baklygter s. 611
- Lyddæmper Avgassystem s. 651
- Støddæmper Støtdämpare s. 681
- Luft-/oliefilter Luft-/oljefilter s. 711
- Kobling Koppling s. 769
- Kabler Wire s. 803
- Styr/greb Styre/handtag s. 829
- Spejle og diverse Speglar och diverse s. 867
- Bøger/værktøj Böcker/verktyg s. 893

Champion tændrør - referenceliste
Champion tændstift - reference-tabell



CHAMPION tændrør - Ref.liste/ CHAMPION tændstift -Ref.tabell

Type	CHAMPION tændrør Varenr.			Type	CHAMPION tændrør Varenr.			Type	CHAMPION tændrør Varenr.		
Type	CHAMPION tændstift Art.nr. DKK SEK			Type	CHAMPION tændstift Art.nr. DKK SEK			Type	CHAMPION tændstift Art.nr. DKK SEK		
8654	091335	67,-	84,-	N5C	091302	30,-	38,-	RG6YC	091327	80,-	100,-
8809	091334	54,-	68,-	N7YC	091372	36,-	45,-	RG59C	091359	84,-	105,-
A59C	091349	140,-	175,-	N12YC	091309	28,-	35,-	RG59V	091346	164,-	205,-
A59GC	091348	162,-	203,-	N6YCC	091314	40,-	50,-	RG92DC	091340	84,-	105,-
C6YCC	091338	40,-	50,-	N7YCC	091313	42,-	53,-	RG94C	091315	92,-	115,-
C55	091356	103,-	129,-	N9YC	091367	28,-	35,-	RG96C	091329	136,-	170,-
C55CX	091330	124,-	155,-	N11YC	091331	30,-	38,-	RL78C	091375	38,-	48,-
C55R	091363	351,-	439,-	QA55V	091345	177,-	221,-	RL82C	091336	36,-	45,-
D14	091305	42,-	53,-	QC59	091355	184,-	230,-	RL82YC	091312	36,-	45,-
G54V	091333	355,-	444,-	QL55	091341	150,-	188,-	RL86C	091361	38,-	48,-
G55R	091343	297,-	371,-	QN84	091324			RN2C	091325	36,-	45,-
G57R	091362	322,-	403,-	QN86	091358	135,-	169,-	RN3C	091318	36,-	45,-
G59C	091354	156,-	195,-	RA4GHC	091321	80,-	100,-	RN4C	091351	38,-	48,-
G63	091320	173,-	216,-	RA4HC	091326	50,-	63,-	RN5C	091319	36,-	45,-
H8C	091311	38,-	48,-	RA6HC	091339	36,-	45,-	RN7C	091353	36,-	45,-
J12YC	091308	30,-	38,-	RA59GC	091322	106,-	133,-	RN7YCC	091370	42,-	53,-
L78C	091344	36,-	45,-	RA8HC	091306	38,-	48,-	RN9YC	091369	32,-	40,-
L82C	091303	28,-	35,-	RAX92C	091368	49,-	61,-	RN9YCC	091357	41,-	51,-
L82YC	091347	30,-	38,-	RAX92YC	091316	42,-	53,-	RN12YC	091304	38,-	48,-
L86C	091342	28,-	35,-	RAX94YC	091317	42,-	53,-	RRG6YC	091373	92,-	115,-
N2C	091350	28,-	35,-	RAX96YC	091310	42,-	53,-	RZ94C	091365	78,-	98,-
N3C	091300	28,-	35,-	RC7BYC4	091376	57,-	71,-	RZ96C	091366	80,-	100,-
N4C	091301	28,-	35,-	RG4HC	091323	124,-	155,-	W 14	091307	161,-	201,-

Platiner til engelske motorcykler
Brytarspetsar till engelska mc

Kondensatorer til engelske mc'er
Kondensatorer till engelska mc

350 Norton 50MK, 500 Norton ES2MK,
 750 Norton P11,
 200 Triumph T20SC,
 500 Triumph,
 650 Triumph 250 BSA,
 Starfire, 441 BSA Royal A50,
 500 Major G80 650 Swift,
 G12, 736 Interception.
 OEM nr. 54415803.
 Ref.nr. DL-50
Varenr. 104400



DKK 58,- SEK 73,-

Passer til: 250 BSA,
 250/500/650
 Triumph.
 OEM nr. 54419827.
 Ref.nr. DL-51
Varenr. 104401



DKK 49,- SEK 61,-

Passer til:
 Triumph Bonneville.
 OEM nr. 60600271.
 Ref.nr. DL-52.
Varenr. 104402



DKK 81,- SEK 101,-

Passer til:
 Triumph Trident
 TR6/TR7.
 OEM nr. 54419828.
 Ref.nr. DL-53.
Varenr. 104403



DKK 62,- SEK 78,-



OEM nr. 54420128. Ref.nr. DLO-1.
Varenr./art.nr. 107995 **DKK 53,- SEK 66,-**



OEM nr. 54441582. Ref.nr. DLO-2.
Varenr./art.nr. 107996 **DKK 45,- SEK 56,-**



OEM nr. 423871. Ref.nr. DLO-3.
Varenr./art.nr. 107997 **DKK 45,- SEK 56,-**



OEM nr. 425377. Ref.nr. DLO-4.
Varenr./art.nr. 107998 **DKK 45,- SEK 56,-**

Platiner och kondensatorer

Brytarspetsar och kondensatorer

Made in Japan



Märke/ modell	Prod. årg.	Platinsæt, Varenr.	højre OEM nr.	Platiner, Varenr.	venstre OEM-nr. (ref.nr.)	Kondensator Varenr.	OEM-nr. (ref.nr.)						
Märke/ modell	Prod. årg.	Brytarspetsar, Art.nr.	höger OEM nr.	DKK	SEK	Brytarspetsar, Art.nr.	vänster Ref.nr.	DKK	SEK	Kondensator Art.nr.	Ref.nr.	DKK	SEK
HONDA													
CB 125 J, S	75-81	104008	30202-107-004	60,-	75:-					107902	30250-330-003	75,-	94:-
CB 125 K(1-5)	71-75	104008	30202-107-004	60,-	75:-					107903	30250-303-000	75,-	94:-
CB 125 T	78	104011	30203-399-000	60,-	75:-	104012	30202-399-000	60,-	75:-				
SL/TL 125 S	76	104008	30202-107-004	60,-	75:-					107903	30250-303-000	75,-	94:-
XL 125 K(2-4)	72-74	104008	30202-107-004	60,-	75:-					107903	30250-303-000	75,-	94:-
CB 200	74	104008	30202-107-004	60,-	75:-					107904	30280-237-005/154		
CB 250 G	75	104009	30203-369-154	60,-	75:-	104010	30202-369-154	60,-	75:-				
CB 250 K(3-4)	73-75	104009	30203-369-154	60,-	75:-	104010	30202-369-154	60,-	75:-	107905	30280-286-701	60,-	75:-
CJ 250 T	77	104009	30203-369-154	60,-	75:-	104010	30202-369-154	60,-	75:-				
XL 250 K(3-4)	73-74	104008	30202-107-004	60,-	75:-					107906	30250-329-305	60,-	75:-
CB 350 F	73-74	104000	30203-333-004	62,-	78:-	104001	30204-333-004	62,-	78:-	107900	30250-300-154	42,-	53:-
CB 350 K(4)	74	104009	30203-369-154	60,-	75:-	104010	30202-369-154	60,-	75:-	107907	30280-292-672	60,-	75:-
CB 360 G	75	104009	30203-369-154	60,-	75:-	104010	30202-369-154	60,-	75:-	107908	30250-369-003	60,-	75:-
CJ 360 T	76	104009	30203-369-154	60,-	75:-	104010	30202-369-154	60,-	75:-	107908	30250-369-003	60,-	75:-
CB 400 F	75-78	104000	30203-333-004	62,-	78:-	104001	30204-333-004	62,-	78:-	107900	30250-300-154	42,-	53:-
CB 450 K	71-75	104002	30203-292-003/154	49,-	61:-	104003	30204-292-003/154	81,-	101:-	107900	30250-300-154	42,-	53:-
CB 500 F/K	70-76	104004	30203-300-005/154	62,-	78:-	104005	30204-300-005/154	62,-	78:-	107900	30250-300-154	42,-	53:-
CB 500 T	75-76	104002	30203-292-003/154	49,-	61:-	104003	30204-292-003/154	81,-	101:-	107900	30250-300-154	42,-	53:-
CB 550 F/K	75-78	104004	30203-300-005/154	62,-	78:-	104005	30204-300-005/154	62,-	78:-	107900	30250-300-154	42,-	53:-
CB 750 F/K	70-79	104004	30203-300-005/154	62,-	78:-	104005	30204-300-005/154	62,-	78:-	107900	30250-300-154	42,-	53:-
GL 1000	74-79	104002	30203-292-003/154	49,-	61:-	104003	30204-292-003/154	81,-	101:-	107900	30250-300-154	42,-	53:-
KAWASAKI													
Z 200 A	77-79	104103	21008-1002	60,-	75:-								
250 S1 (Alle 3 cyl.)	72-75	104104	21008-019 H+V	60,-	75:-	104104	21008-019 M	60,-	75:-	107952	21013-026	75,-	94:-
KH 250 (Alle 3 cyl.)	76-77	104104	21008-019 H+V	60,-	75:-	104104	21008-019 M	60,-	75:-	107952	21013-026	75,-	94:-
KL 250 A	78	104103	21008-1002	60,-	75:-								
Z 250 A,J	79-82	104107	21008-1010	60,-	75:-	104108	21008-1009	60,-	75:-	107953	21013-1003	75,-	94:-
Z 250 C	80	104103	21008-1002	60,-	75:-								
350 S2 (Alle 3 cyl.)	72-73	104104	21008-019 H+V	60,-	75:-	104104	21008-019 M	60,-	75:-	107952	21013-026	75,-	94:-
400 S3 (Alle 3 cyl.)	74-75	104104	21008-019 H+V	60,-	75:-	104104	21008-019 M	60,-	75:-	107952	21013-026	75,-	94:-
KH 400 (Alle 3 cyl.)	76-78	104105	21008-023/025	60,-	75:-	104105	21008-023/025	60,-	75:-	107952	21013-026	75,-	94:-
Z 400 2 cyl.	74-76	104102	21008-025	58,-	73:-					107954	21013-034	75,-	94:-
Z 400 2 cyl.	77>	104101	21008-022/027	81,-	101:-					107955	21013-031	75,-	94:-
Z 400 J	80-81	104100	21008-021/028	81,-	101:-	104101	21008-022/027	81,-	101:-	107950	21013-037	90,-	113:-
H1, KH 500	69>	104106	21082-007 H+V	60,-	75:-	104106	21082-007 M	60,-	75:-				
Z 500	79-80	104100	21008-021/028	81,-	101:-	104101	21008-022/027	81,-	101:-	107950	21013-037	90,-	113:-
Z 650	77-80	104100	21008-021/028	81,-	101:-	104101	21008-022/027	81,-	101:-	107950	21013-037	90,-	113:-
Z 750 B1/B2	76-78	104102	21008-025	58,-	73:-					107954	21013-034	75,-	94:-
Z 750 B3 (2 cyl.)	78	104101	21008-021/027	81,-	101:-					107954	21013-034	75,-	94:-
Z 900	73-76	104100	21008-021/028	81,-	101:-	104101	21008-022/027	81,-	101:-	107951	21013-029	96,-	120:-
Z 1000	77-79	104100	21008-021/028	81,-	101:-	104101	21008-022/027	81,-	101:-	107951	21013-029	96,-	120:-
SUZUKI													
GT 125	78-79	104207	33172-33020	60,-	75:-	104208	31440-15020	60,-	75:-		31641-36210		
GSX 250	80-82	104200	33140-45020	58,-	73:-	104201	33160-45020	58,-	73:-	107960	32341-31010	44,-	55:-
GT 250	73-78	104207	33172-33020	60,-	75:-	104208	31440-15020	60,-	75:-	107962	31641-18521/22 H	75,-	94:-
										107963	31642-18521/22 V	75,-	94:-
GT 350 Twin	Alle	104207	33172-33020	60,-	75:-	104208	31440-15020	60,-	75:-	107962	31641-18521/22 H	75,-	94:-
										107963	31642-18521/22 V	75,-	94:-
GT 380 (Kokusen H+V)	73-77	104208	31440-15020	60,-	75:-	104208	31440-15020	60,-	75:-	107964	33261-33020 V	95,-	119:-
GT 380 (Kokusen Midt)	73-77	104207	33172-33020	60,-	75:-					107966	33263-33020 M	95,-	119:-
GT 380 (Denso H+V)	73-77	104209	33170-33010	60,-	75:-	104209	33170-33010	60,-	75:-	107965	33262-33020 H	95,-	119:-
GT 380 (Denso Midt)	73-77	104210	33160-33010	60,-	75:-					107966	33263-33020 M	95,-	119:-
GS 400/425	77-79	104204	33140-44010	81,-	101:-	104205	33160-44010	81,-	101:-		33421-44020		
GSX 400 E	80	104200	33140-45020	58,-	73:-	104201	33160-45020	58,-	73:-	107960	32341-31010	44,-	55:-
GS 450	80>	104200	33140-45020	58,-	73:-	104201	33160-45020	58,-	73:-	107960	32341-31010	44,-	55:-
GS 550	77-80	104200	33140-45020	58,-	73:-	104201	33160-45020	58,-	73:-	107960	32341-31010	44,-	55:-

- Stikord
Sökord
s. 2-5
- Forhandlere
Aterforsäljare
s. 6-9
- Tøj/hjelme
Klæder/
hjelmar
s. 11
- Dæk
Dæk
s. 83
- Olie
Olja
s. 115
- Kæde/
tandhjul
Kedjor/
drev
s. 145
- Bremser
Broms
s. 187
- Låse
Lås
s. 347
- Batteri
Batterier
s. 355
- Pakninger
Packingar
s. 377
- Motordele
Motordelar
s. 411
- Lejer
Lager
s. 435
- Karburator
Förgasare
s. 467
- El-dele/
Tænding
Elektrisk/
Tænding
s. 509
- Blinklygter
Baglygter
Belysning
Baklygter
s. 611
- Lyddæmper
Avgassystem
s. 651
- Støddæmper
Støtdæmpere
s. 681
- Luft/
oljefilter
Luft/
oljefilter
s. 711
- Kobling
Koppling
s. 769
- Kabler
Wire
s. 803
- Styr/greb
Styre/
handtag
s. 829
- Spejle
og diverse
Speglar
och diverse
s. 867
- Bøger/
værktøj
Böcker/
verktyg
s. 893

Platiner og kondensatorer Brytarspetsar och kondensatorer



Made in Japan



Mærke/ model	Prod. årg.	Platinsæt, højre Varenr. OEM nr.	Platiner, venstre Varenr. OEM-nr. (ref.nr.)	Brytarspetsar, vänster		Kondensator		Brytarspetsar, höger		Kondensator			
Mærke/ modell	Prod. årg.	Brytarspetsar, vänster Art.nr. OEM nr.	DKK SEK Art.nr. Ref.nr.	DKK SEK Art.nr. Ref.nr.	DKK SEK Art.nr. Ref.nr.	DKK SEK Art.nr. Ref.nr.							
SUZUKI													
NY GT 500 Twin	Alle	104207	33172-33020	60,-	75,-	104208	31440-15020	60,-	75,-	107962	31641-18521/22 H	75,-	94,-
										107963	31642-18521/22 V	75,-	94,-
NY GT 550 (Kokusan H+V)	73-77	104212	33160-34020	60,-	75,-	104212	33160-34020	60,-	75,-	107967	32341-34020 V	95,-	119,-
NY GT 550 (Kokusan Midt)	73-77	104211	33170-34020	60,-	75,-					107968	32342-34020 H	95,-	119,-
NY GT 550 (Denso H+V)	73-77	104213	33170-31010	60,-	75,-	104213	33170-31010	60,-	75,-	107969	32343-34020 M	95,-	119,-
NY GT 550 (Denso Midt)	73-77	104214	33160-31010	60,-	75,-					107967	32341-34020 V	95,-	119,-
NY GS 750	77	104200	33140-45020	58,-	73,-	104201	33160-45020	58,-	73,-	107960	32341-31010	44,-	55,-
NY GT 750 (Denso H+V)	78-79	104202	33172-36210	62,-	78,-	104203	31440-36210	62,-	78,-	107960	32341-31010	44,-	55,-
NY GT 750 (Denso Midt)	72-77	104213	33170-31010	60,-	75,-	104213	33170-31010	60,-	75,-	107967	32341-34020 V	95,-	119,-
NY GS 850	78-79	104202	33172-36210	62,-	78,-	104203	31440-36210	62,-	78,-	107968	32342-34020 H	95,-	119,-
NY GS 1000	78-79	104202	33172-36210	62,-	78,-	104203	31440-36210	62,-	78,-	107969	32343-34020 M	95,-	119,-
										107960	32341-31010	44,-	55,-

YAMAHA

NY RS 100	75-76	104308	207-81321-10	60,-	75,-					107981	IK8-81325-20	49,-	61,-
NY RS 100 DX	79-81	104309	2A6-81321-20	68,-	85,-					107981	IK8-81325-20	49,-	61,-
NY DT 125 (AS1)		104310	132-81321-10	60,-	75,-					107982	148-81126-10		
NY DT 125	74-75	104312	214-81321-20	60,-	75,-								
NY DT 125 E	76-79	104310	132-81221-10	60,-	75,-					107981	IK8-81325-20	49,-	61,-
NY RD 125 DX	75-77	104311	183-81421-00	60,-	75,-					107983	183-81425-10	60,-	75,-
NY DT 175	75-76	104312	214-81321-20	60,-	75,-					107984	277-81326-10	60,-	75,-
NY DT 175 MX	77-81	104313	443-81321-10	60,-	75,-					107984	277-81326-10	60,-	75,-
NY RD 200, DX	75-79	104311	183-81421-00	60,-	75,-	104311	183-81421-00	60,-	75,-	107976	132-81225-10	60,-	75,-
NY DT 250 (512)	74-76	104312	214-81321-20	60,-	75,-								
NY DT 250 MX (1R7)	77-80	104314	438-81321-20	60,-	75,-								
NY RD 250 (522)	>75	104315	131-81221-20	60,-	75,-	104315	131-81221-20	60,-	75,-	107977	278-81625-20R	60,-	75,-
NY RD 250 (522)	>75	104316	278-81621-20	60,-	75,-	104317	278-81622-20	60,-	75,-	107978	278-81626-20L	60,-	75,-
NY RD 250 DX (1A2)	76-79	104318	371-81621-10	60,-	75,-	104319	371-81622-10	60,-	75,-	107979	1A0-81625-10	60,-	75,-
NY XS 250	80-81	104301	119-81622-50	53,-	66,-	104302	119-81621-50	58,-	73,-	107973	119-81625-50	176,-	220,-
NY RD 350 (521)	>75	104315	131-81221-20	60,-	75,-	104315	131-81221-20	60,-	75,-	107977	278-81625-20R	60,-	75,-
NY RD 350 (521)	>75	104316	278-81621-20	60,-	75,-	104317	278-81622-20	60,-	75,-	107978	278-81626-20L	60,-	75,-
NY XS 360		104301	119-81622-50	53,-	66,-	104302	119-81621-50	58,-	73,-	107973	119-81625-50	176,-	220,-
NY RD 400 (1A3)	76-79	104318	371-81621-10	60,-	75,-	104319	371-81622-10	60,-	75,-	107979	1A0-81625-10	60,-	75,-
NY XS 400	80-82	104301	119-81622-50	53,-	66,-	104302	119-81621-50	58,-	73,-	107973	119-81625-50	176,-	220,-
NY XS 500 (1H2)	76-78	104318	371-81621-10	60,-	75,-	104319	371-81622-10	60,-	75,-	107980	371-81625-10	85,-	106,-
NY XT 500	Alle	104300	583-81621-50	62,-	78,-					107974	583-81625-50	35,-	44,-
NY XS 650/XSI/2	75-81	104303	256-81612-11/10	53,-	66,-					107970	256-81625-10	115,-	144,-
NY TX 750	Alle	104303	256-81612-11/10	53,-	66,-					107970	256-81625-10	115,-	144,-
NY XS 750	77-80	104304	117-81621-10	62,-	78,-	104305	117-81622-10	53,-	66,-	107975	117-81625-10	35,-	44,-



Tændingsplader komplette
Tændplatta komplett

Made in Japan

Tændingsplader - komplette
Tændplatta - komplett
til/till Honda



Passer til/passar till:
 CB 400 F,
 CB 500 F/K,
 CB 550 K1,
 CB 750 F.
 OEM nr. 30200-300-154.

Ref.nr. DH-34B2.
 Varenr/art.nr. 104500 **347,-** **434,-**

Tændingsplader - komplette
Tændplatta - komplett
til/till Kawasaki



Passer til/
 passer till:
 Z900 Z1/A/B,
 Z1000 A1.
 OEM nr. 21135-011.

Ref.nr. DT-1B.
 Varenr/art.nr. 104502 **358,-** **448,-**

Tændingsplader - komplette
Tændplatta - komplett
til/till Honda



Passer til/passar till:
 CB 250 / CB 350
 OEM nr. 30200-286-004

Varenr/art.nr. 104503 **358,-** **448,-**

Sökord s. 2-5

Forhandlere Aterforsaljare s. 6-9

Tøj/hjelme Klæder/hjælmar s. 11

Dæk Däck s. 83

Olie Olja s. 115

Kæde/tandhjul Kedjor/drev s. 145

Bremser Broms s. 187

Låse Lås s. 347

Batteri Batterier s. 355

Pakninger Packningar s. 377

Motordele Motordelar s. 411

Lejer Lager s. 435

Karburator Förgasare s. 467

El-dele/ Tænding Elektriskt/ Tænding s. 509

Blinklygter Baglygter Belysning Baklygter s. 611

Lyddæmper Avgassystem s. 651

Støddæmper Støtdåmpare s. 681

Luft/oliefilter Luft/oljefilter s. 711

Kobling Koppling s. 769

Kabler Wire s. 803

Styr/greb Styre/handtag s. 829

Spejle og diverse Speglar och diverse s. 867

Bøger/værktøj Bøcker/verktyg s. 893

Champion tændrørshætter - Optimale egenskaber

Champion tändhattar - Optimala egenskaper



Champion's bløde, røde tændrørshætte er udført i silikonegummi og er radiostøddæmpet med en 5 K modstand. Ribbede ender giver den mest vandtætte samling. Silikonegummiet er varmefast op til 250 grader.

Champions mjuke röda tändhätt i silikongummi. Räfflad ända ger den mest vattentäta kopplingen. Silikongummit är varmefast upp till 250 grader. Radioavstörd med ett 5 K motstånd.

Tændrørshætter

Blød, rød silikonegummi tændrørshætte. 5 K modstand. Ref.nr. PRO5



Tändhattar

Mjuk, röd, silikongummi tändhätt. 5K motstånd. Ref.nr. PRO5M.



DKK 50,- SEK 63,-

Varenr./art.nr. 103998

Tændrørshætter til CX Honda

Japansk tændhætte, dæmpet 5 K. Passer til CX 500/650 Honda. OEM nr. 30700-415-000 Ref.nr. 2G15



Tändhattar till CX Honda

Japansk tändhätt, radioavstörd 5K. Passer till CX 500/650 Honda. OEM nr. 30700-415-000 Ref.nr. 2G15

DKK 117,- SEK 146,-

Varenr./art.nr. 103995

Tændrørshætter

Gummi tændrørshætte (til cross). Ikke støjdæmpet.



Tändhattar

Gummi tändhätt till cross, ej radioavstörd.

DKK 27,- SEK 34,-

Varenr./art.nr. 103997

Tændrørshætter

Gummi tændrørshætte (til cross). Ikke støjdæmpet.



Tändhattar

Gummi tändhätt till cross, ej radioavstörd.

DKK 27,- SEK 34,-

Sort/svart

Varenr./art.nr. 103999

Rød/röd

Varenr./art.nr. 103996

Tændrørskabel

Universal tændkabel. Passer på alle tændspoler med løs tændkabel. Længde: 60 cm. Ref.nr. 28-47826



Tändkabel

Universal tändkabel som passar på alla tändspolar med lös tändkabel. Längd 60 cm. Ref.nr. 28-47826

DKK 47,- SEK 59,-

Varenr./art.nr. 091100

NGK tændrørshætter - Dæmper støjen effektivt

NGK tændhatter - Effektivt mot störningar

NGK's radiostøjdæmpede tændrørshætter leverer i kombination med NGK tændrør optimale præstationer for motoren uden at have nogen skadelige virkninger for miljøet. NGK tændrørshætter er radiostøjdæmpede med 1K og 5 K modstand, og lavet i et førsteklasses, keramisk materiale.

NGK radioavstørda tændhatter kombinerat med NGK tændstift är den optimale lösningen. Effektivare förbränning, bättre prestation och skonsammare mot miljön. NGK tändhatter är radioavstörda med 1 K och 5 K motstånd och tillverkade av första klassens keramiskt material.

NGK tændrørshætter
Radiostøjdæmpet med 5K eller 1K.

NGK tændhatter
Radioavstørda med 5K eller 1K.

Modstand/
motstånd: 5k.
NGK ref.nr. SD05F.
Varenr./art.nr. 103900

DKK 40,- SEK 50,-

Modstand/
motstånd: 1k.
NGK ref.nr. SD01F.
Varenr./art.nr. 103901

DKK 40,- SEK 50,-

Modstand/
motstånd: 5k.
NGK ref.nr. XD05F.
Varenr./art.nr. 103950

DKK 51,- SEK 64,-

Modstand/
motstånd: 1k.
NGK ref.nr. XD01F.
Varenr./art.nr. 103951

DKK 51,- SEK 64,-

NGK tændrørshætter
Radiostøjdæmpet med 5K eller 1K.

NGK tændhatter
Radioavstørda med 5K eller 1K.

Modstand/
motstånd: 5k.
NGK ref.nr. VD05F.
Varenr./art.nr. 103960

DKK 48,- SEK 60,-

Modstand/
motstånd: 1k.
NGK ref.nr. VD01F.
Varenr./art.nr. 103961

DKK 48,- SEK 60,-

Modstand/
motstånd: 5k.
NGK ref.nr. LB05F.
Varenr./art.nr. 103990

DKK 34,- SEK 43,-

Modstand/
motstånd: 1k.
NGK ref.nr. LB01F.
Varenr./art.nr. 103991

DKK 34,- SEK 43,-

Tændhætte
Tändhatt
Ref.nr. SD05FM

Varenr./art.nr. 103992

DKK 97,- SEK 121,-

Tændhætte
Tändhatt
Ref.nr. TB05EMA

Varenr./art.nr. 103993

DKK 97,- SEK 121,-

Kabelsamler
Kabelamlare
Ref.nr. J1/8739

Varenr./art.nr. 103994

DKK 62,- SEK 78,-

Racingkabel 5 Ω
Racingkabel 5 Ω

Varenr. Art.nr.	Lgd. i cm	Ref.nr.	DKR	SEK
103800	50	CR1	218,-	273,-
103801	50	CR2	218,-	273,-
103802	50	CR3	218,-	273,-
103803	50	CR4	218,-	273,-
103804	100	CR5	218,-	273,-
103805	100	CR6	218,-	273,-

Varenr. 103800, 103802

Stikord Sökord s. 2-5

Forhandlere Aterförsäljare s. 6-9

Tøj/hjelme Kläder/hjälmor s. 11

Dæk Däck s. 83

Olje Olja s. 115

Kæde/tandhjul Kedjor/drev s. 145

Bremser Broms s. 187

Låse Lås s. 347

Batteri Batterier s. 355

Pakninger Pakningar s. 377

Motordele Motordelar s. 411

Lejer Lager s. 435

Karburator Förgasare s. 467

El-dele/Tænding Elektriskt/Tänding s. 509

Blinklygter Baglygter Belysning Baklygter s. 611

Lyddæmper Avgassystem s. 651

Støddæmper Støtdämpare s. 681

Luft/oliefilter Luft/oljefilter s. 711

Kobling Koppling s. 769

Kabler Wire s. 803

Styr/greb Styre/handtag s. 829

Spejle og diverse Speglar och diverse s. 867

Bøger/værktøj Bøcker/verktyg s. 893

Tændspole
Tändspole



Tændspole
Tändspole

HONDA:

Model/Årg.:

CB 650, 80-82,
CB 750 KZ, 79-82 - CB 750 F, 82-83,
CB 750 C, 80-83 - CB 900 F/C, 81-83,
CBX 1000, 81-82 - CB 1100 F, 83-84.
OEM nr. 30500-422-003/013



Mont.huller afstand: 102 mm
Fåsthål afstand: 102 mm.

DKK **SEK**

Ref.nr. 24-37810

Varenr./art.nr. 091104

282,- **353:-**

Tændspole
Tändspole

SUZUKI:

Model

GSX750/1100R

OEM nr. 2077-10-3002



Mont.huller afstand: 90 mm.
Fåsthål afstand: 90 mm.

DKK **SEK**

Varenr./art.nr. 091123

338,- **423:-**

Tændspole
Tändspole

Mont.huller afstand: 102 mm.
Fåsthål afstand: 102 mm.

HONDA:

CB 400 N/T/CM

OEM nr. 2077-10-1005/

30530-413-003



DKK **SEK**

Varenr./art.nr. 091124

253,- **316:-**

Tændspole
Tändspole

YAMAHA:

Model: XV535

1 stk.

OEM nr. 2077-10-2002

Ref.nr. 24-72403



Mont.huller afstand: 80 mm.
Fåsthål afstand: 80 mm.

DKK **SEK**

Varenr./art.nr. 091122

191,- **239:-**

Tændspole
Tändspole

KAWASAKI:

Model/Årg.:

Z 400 Twin, 76-79

Z 750 Twin, 77-79

Z 650 B-F, 76-80 • Z1/Z900, 73-76

Z 1000, 77-79

OEM nr.

SUZUKI:

Model/Årg.:

GS 550, 76-79 • GS 750, 76-79

GS 850, 77-79 • GS 1000, 77-79.

OEM nr. 33410-45012

Ref.nr. 24-72451



Mont.huller afstand: 90 mm.
Fåsthål afstand: 90 mm.

DKK **SEK**

Varenr./art.nr. 091108

338,- **423:-**

DKK Leveres med 57,5 cm lange tændrørs-ledninger, skal afkortes til cyl. 2-3.

SEK Levereras med 57,5 cm långa tändkablar. Skall avkortas till cylinder 2-3 längd.

Universal tændspole
Universal tändspole

6 Volt

Ref.nr. 24-71506

DKK **SEK**

Varenr./art.nr. 091133

159,- **199:-**



Universal tændspole
Universal tändspole

12 Volt

Ref.nr. 24-71512

DKK **SEK**

Varenr./art.nr. 091134

159,- **199:-**



Tændspole
Tändspole



HONDA CR/XR/TRX

Varenr./Art.nr. Ref.nr.

091126 28-71536



DKR **SEK**

253,- **316:-**

Pick Up spole
Pick Up spolrar

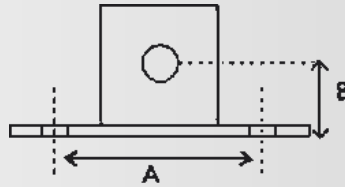

■ A, B og C: Mål i mm.
D: Ohm modstand.

■ A, B, och C: Mått i mm.
D: Ohm motstånd.

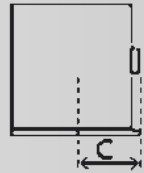

Honda, GasGas, KTM, Suzuki.
A: 35 mm. B: 13 mm.
C: 6 mm. D: 100 Ω
Ref.nr.: P1
Varenr./art.nr. 091150
■DKK 395,- ■SEK 494,-

Honda, Yamaha
A: 30 mm. B: 13 mm.
C: 3 mm. D: 128 Ω
Ref.nr.: P2
Varenr./art.nr. 091151
■DKK 395,- ■SEK 494,-

Yamaha, KTM
A: 33 mm. B: 6 mm.
C: 9 mm. D: 250 Ω
Ref.nr.: P3
Varenr./art.nr. 091152
■DKK 395,- ■SEK 494,-

Honda
A: 36 mm. B: 14 mm.
C: 10 mm. D: 220 Ω
Ref.nr.: P4
Varenr./art.nr. 091153
■DKK 395,- ■SEK 494,-

Yamaha
A: 35 mm. B: 8 mm.
C: 7 mm. D: 280 Ω
Ref.nr.: P5
Varenr./art.nr. 091154
■DKK 395,- ■SEK 494,-

Honda, Yamaha Suzuki
A: 35 mm. B: 14 mm.
C: 5 mm. D: 280 Ω
Ref.nr.: P6
Varenr./art.nr. 091155
■DKK 395,- ■SEK 494,-

Honda, Kawasaki
A: 30 mm. B: 14 mm.
C: 3 mm. D: 228 Ω
Ref.nr.: P7
Varenr./art.nr. 091165
■DKK 395,- ■SEK 494,-

Ducati Twins
A: 30 mm. B: 14 mm.
C: 4,5 mm. D: 460 Ω
Ref.nr.: P8
Varenr./art.nr. 091156
■DKK 395,- ■SEK 494,-

Universal
A: 34 mm. B: 14 mm.
C: 4 mm. D: 230 Ω
Ref.nr.: P11
Varenr./art.nr. 091157
■DKK 395,- ■SEK 494,-

Honda
A: 38 mm. B: 7 mm.
C: 9 mm. D: 250 Ω
Ref.nr.: P13
Varenr./art.nr. 091158
■DKK 395,- ■SEK 494,-

Yamaha WR250 (90-95), YZ250 (90-95)
A: - mm. B: - mm.
C: - mm. D: - Ω
Ref.nr.: P14
Varenr./art.nr. 091159
■DKK 395,- ■SEK 494,-

Honda
A: 34 mm. B: 15 mm.
C: 4 mm. D: 150 Ω
Ref.nr.: P20
Varenr./art.nr. 091160
■DKK 395,- ■SEK 494,-

Universal
A: 36 mm. B: 15 mm.
C: 6 mm. D: 120 Ω
Ref.nr.: P21
Varenr./art.nr. 091161
■DKK 395,- ■SEK 494,-

Universal
A: 33 mm. B: 6 mm.
C: 12 mm. D: 440 Ω
Ref.nr.: P22
Varenr./art.nr. 091162
■DKK 395,- ■SEK 494,-

Yamaha YZ490, YZ465
A: - mm. B: - mm.
C: - mm. D: - Ω
Ref.nr.: P30
Varenr./art.nr. 091163
■DKK 395,- ■SEK 494,-

Kawasaki, Yamaha
A: - mm. B: - mm.
C: - mm. D: - Ω
Ref.nr.: P31
Varenr./art.nr. 091164
■DKK 395,- ■SEK 494,-

Stikord Sökord s. 2-5

Forhandlere Aterforsaljare s. 6-9

Toj/hjelme Kläder/hjälmar s. 11

Däck Däck s. 83

Olje Olja s. 115

Kæde/tandhjul Kedjor/drev s. 145

Bremser Broms s. 187

Låse Lås s. 347

Batteri Batterier s. 355

Pakninger Packningar s. 377

Motordele Motordelar s. 411

Lejer Lager s. 435

Karburator Förgasare s. 467

El-dele/ Tænding Elektriskt/Tænding s. 509

Blinklygter Baglygter Belysning Baklygter s. 611

Lyddæmper Avgassystem s. 651

Støddæmper Støtdæmpere s. 681

Luft-/oliefilter Luft-/oljefilter s. 711

Kobling Koppling s. 769

Kabler Wire s. 803

Styr/greb Styre/handtag s. 829

Spejle og diverse Speglar och diverse s. 867

Bøjer/værktøj Böcker/verktyg s. 893



DK MemJet er et indsprøjtningssmodul, der er nemt, billigt, hurtigt, enkelt og justerbart! MemJet er effekt!

På 5 minutter får du en roligere motorgang og mere effekt på din MC. Memjet er let at montere. Af med sædet, stik af, stik på, sæt Memjet på 2, på med sædet og kø. Ingen rullefelt, ingen værksted, ingen beskidte fingre. Kun montering af en lille sort box. Nu har du fået en friskere MC. God tur!

SE MemJet är ett insprutningsmodul, der är billigt, snabbt och enkelt justerbart! MemJet är effekt!

På 5 minutter får du roligere kraft og mer effekt på din MC. MemJet är lätt att montera. Av med sadel, kontakt av, kontakt på, sätt MemJet på 2, på med sadel och kör. Ingen bänkning, Ingen verkstad, inga skitiga fingrar. Endast montering av en liten svart box. Nu har du en mycket trevligare MC. God tur!

Mærke/Model	Prod. Årg.	Varenr.	Ref.nr.		
Mærke/Modell	Prod. Årg.	Art.nr.	Ref.nr.	DKK	SEK
APRILIA					
DORSODURO	08-10	240014	APRILIA 1	1573,-	1966:-
FALCO	00>	240017	APRILIA 11	1573,-	1966:-
FUTURA	01-03	240015	APRILIA 4	1573,-	1966:-
MANA	09-10	240015	APRILIA 4	1573,-	1966:-
PEGASO	01-04	240015	APRILIA 4	1573,-	1966:-
RSV R	05	240017	APRILIA 11	1573,-	1966:-
RXV	06-09	240000	APRILIA 8	1573,-	1966:-
SHIVER	08-10	240014	APRILIA 1	1573,-	1966:-
SXV	06-10	240000	APRILIA 8	1573,-	1966:-
TUONO	02-05	240017	APRILIA 11	1573,-	1966:-
ATLANTIC 400 IE		240015	APRILIA 4	1573,-	1966:-
MXV 450	06-09	240000	APRILIA 8	1573,-	1966:-
NY RXV-SXV 450	06-10	240000	APRILIA 8	1573,-	1966:-
ATLANTIC 500 IE		240040	APRILIA 5	1573,-	1966:-
SCARABEO 500 IE		240040	APRILIA 5	1573,-	1966:-
NY MXV 550	06-09	240000	APRILIA 8	1573,-	1966:-
NY RXV-SXV 550	06-10	240000	APRILIA 8	1573,-	1966:-
PEGASO 660	05-08	240016	APRILIA 9	1573,-	1966:-
RSV1000	98-03	240017	APRILIA 11	1573,-	1966:-
RSV 1000	04-08	240041	APRILIA 6	1573,-	1966:-
TUONO 1000	04-08	240041	APRILIA 6	1573,-	1966:-
CAPONORD 1000	01-08	240015	APRILIA 4	1573,-	1966:-
BMW					
F 650 CS		240013	BMW 4 L	1573,-	1966:-
F 650 GS / Dakar		240013	BMW 4 L	1573,-	1966:-
F 650 ST		240013	BMW 4 L	1573,-	1966:-
NY G 650 X-Country		240013	BMW 4	1573,-	1966:-
NY G 650 X-Moto X-Challenge		240013	BMW 4	1573,-	1966:-
F 800 S		240013	BMW 4 L	1573,-	1966:-
F 800 ST		240013	BMW 4 L	1573,-	1966:-
F 800 GS		240013	BMW 4 L	1573,-	1966:-
R 850 RT		240012	BMW 4 C	1573,-	1966:-

Mærke/Model	Prod. Årg.	Varenr.	Ref.nr.		
Mærke/Modell	Prod. Årg.	Art.nr.	Ref.nr.	DKK	SEK
BMW					
R 850 R		240012	BMW 4 C	1573,-	1966:-
R 850 GS		240012	BMW 4 C	1573,-	1966:-
K 1100 RT		240012	BMW 4 C	1573,-	1966:-
R 1100 RT		240012	BMW 4 C	1573,-	1966:-
R 1100 S		240012	BMW 4 C	1573,-	1966:-
R 1100 R		240012	BMW 4 C	1573,-	1966:-
R 1100 RS		240012	BMW 4 C	1573,-	1966:-
R 1100 GS		240012	BMW 4 C	1573,-	1966:-
R 1150 GS		240012	BMW 4 C	1573,-	1966:-
R 1150 R		240012	BMW 4 C	1573,-	1966:-
R 1150 R S		240012	BMW 4 C	1573,-	1966:-
R 1150 RT		240012	BMW 4 C	1573,-	1966:-
R 1200 GS		240013	BMW 4 L	1573,-	1966:-
R 1200 RT		240013	BMW 4 L	1573,-	1966:-
R 1200 R		240013	BMW 4 L	1573,-	1966:-
R 1200 S		240013	BMW 4 L	1573,-	1966:-
R 1200 RS		240013	BMW 4 L	1573,-	1966:-
R 1200 C		240013	BMW 4 L	1573,-	1966:-
K 1200 GT		240013	BMW 4 L	1573,-	1966:-
K 1200 LT		240013	BMW 4 L	1573,-	1966:-
K 1200 R		240013	BMW 4 L	1573,-	1966:-
K 1200 RS		240013	BMW 4 L	1573,-	1966:-
K 1200 S		240013	BMW 4 L	1573,-	1966:-
HP2/Sport		240013	BMW 4 L	1573,-	1966:-
MEGAMOTO		240013	BMW 4 L	1573,-	1966:-
DUCATI					
MONSTER 400		240019	DUC 2	1573,-	1966:-
MONSTER 620		240019	DUC 2	1573,-	1966:-
MONSTER 620 (5 gear)		240019	DUC 2	1573,-	1966:-
NY MONSTER 620 (6 gear)		240019	DUC 2	1573,-	1966:-
620 Sport		240018	DUC 1	1573,-	1966:-
MONSTER 695		240020	DUC 3	1573,-	1966:-

Märke/Model	Prod. Årg.	Varenr.	Ref.nr.	DKK	SEK
DUCATI					
MONSTER 696		240018	DUC 1	1573,-	1966:-
748 -S-R-A-SPS-R-RACING-BIP.		240018	DUC 1	1573,-	1966:-
749 -S-R-A-SPS-R-RACING-BIP.		240018	DUC 1	1573,-	1966:-
MONSTER 750 IE		240019	DUC 2	1573,-	1966:-
SPORT 750		240018	DUC 1	1573,-	1966:-
SUPERSPORT 750 -IE		240018	DUC 1	1573,-	1966:-
MONSTER 800		240019	DUC 2	1573,-	1966:-
MONSTER S2R 800	07	240020	DUC 3	1573,-	1966:-
SUPER SPORT 800		240019	DUC 2	1573,-	1966:-
SPORT 800		240019	DUC 2	1573,-	1966:-
S 2R 800 NO 2007		240019	DUC 2	1573,-	1966:-
848		240018	DUC 1	1573,-	1966:-
SUPERSPORT-IE 900		240018	DUC 1	1573,-	1966:-
SPORT 900		240018	DUC 1	1573,-	1966:-
MONSTER 900 IE		240018	DUC 1	1573,-	1966:-
MH EVOLUZIONE 900		240018	DUC 1	1573,-	1966:-
916		240018	DUC 1	1573,-	1966:-
996-SPS-S-RS-RACING-SP-BIPOSTO		240018	DUC 1	1573,-	1966:-
998 -S-R-MATRIX		240019	DUC 2	1573,-	1966:-
998 -RS		240018	DUC 1	1573,-	1966:-
999 -S-R-RS		240018	DUC 1	1573,-	1966:-
GT 1000		240020	DUC 3	1573,-	1966:-
SUPERSPORT 1000		240019	DUC 2	1573,-	1966:-
SPORT 1000		240019	DUC 2	1573,-	1966:-
SPORT 1000 -S		240020	DUC 3	1573,-	1966:-
ST 3 1000		240018	DUC 1	1573,-	1966:-
MONSTER S2R 1000		240019	DUC 2	1573,-	1966:-
MONSTER S1000		240019	DUC 2	1573,-	1966:-
MONSTER 1000		240019	DUC 2	1573,-	1966:-
MONSTER S2R 1000 DS		240019	DUC 2	1573,-	1966:-
MULTISTRADA DS 1000		240018	DUC 1	1573,-	1966:-
MULTISTRADA 1100-1000		240018	DUC 1	1573,-	1966:-
1098 - S - R		240018	DUC 1	1573,-	1966:-
1198 - S		240018	DUC 1	1573,-	1966:-
DESMOSEDICI		240018	DUC 1	1573,-	1966:-
HYPERMOTRD -S		240020	DUC 3	1573,-	1966:-
MH Evoluzione		240018	DUC 1	1573,-	1966:-
MONSTER S4R		240019	DUC 2	1573,-	1966:-
MONSTER S4RS		240020	DUC 3	1573,-	1966:-
PAUL SMART		240019	DUC 2	1573,-	1966:-
STREETFIGHTER		240018	DUC 1	1573,-	1966:-
ST2		240018	DUC 1	1573,-	1966:-
ST 4		240018	DUC 1	1573,-	1966:-
ST4 S -ABS		240019	DUC 2	1573,-	1966:-

HARLEY DAVIDSON

FXDB Dyna street bob		240025	H-D 1	1573,-	1966:-
FXDC Dyna super glide		240025	H-D 1	1573,-	1966:-
FXDF Dyna fat bob		240025	H-D 1	1573,-	1966:-
FXSTC Softtail		240025	H-D 1	1573,-	1966:-
FXSTB Night train		240025	H-D 1	1573,-	1966:-
FXCW Softail rocker		240025	H-D 1	1573,-	1966:-
FLSTSB Sostai cross bones		240025	H-D 1	1573,-	1966:-
FLSTF fat boy		240025	H-D 1	1573,-	1966:-
FLSTC Heritage softail		240025	H-D 1	1573,-	1966:-
FXCW Sostai roker c		240025	H-D 1	1573,-	1966:-
FLHT Electra glide		240025	H-D 1	1573,-	1966:-
FLHR Road king		240025	H-D 1	1573,-	1966:-
FLHRC Road king classic		240025	H-D 1	1573,-	1966:-
FLHX Street glide		240025	H-D 1	1573,-	1966:-
FLHTCU ultra classic		240025	H-D 1	1573,-	1966:-
L V ROD		240027	H-D 4	1573,-	1966:-
L NIGHT ROD SPECIAL		240027	H-D 4	1573,-	1966:-
L V-ROD MUSCLE		240027	H-D 4	1573,-	1966:-
Nightrod Special		240027	H-D 4	1573,-	1966:-
883		240026	H-D 3	1573,-	1966:-
XL 883 / L / R / C		240026	H-D 3	1573,-	1966:-
V-Rod 1130		240027	H-D 4	1573,-	1966:-
XL 1200N / L / C		240026	H-D 3	1573,-	1966:-
XR 1200		240026	H-D 3	1573,-	1966:-
XR 1200 Sportster		240026	H-D 3	1573,-	1966:-
V-rod 1250		240027	H-D 4	1573,-	1966:-
EVO 1340 Injection		240025	H-D 1	1573,-	1966:-
Dyna 1450 Injection		240025	H-D 1	1573,-	1966:-
Softail 1450 Injection		240025	H-D 1	1573,-	1966:-
Touring Twin cam 1450		240025	H-D 1	1573,-	1966:-
Twin cam 1450 Injection		240025	H-D 1	1573,-	1966:-
Dyna 1580 Injection		240025	H-D 1	1573,-	1966:-

Märke/Model	Prod. Årg.	Varenr.	Ref.nr.	DKK	SEK
-------------	------------	---------	---------	-----	-----

HARLEY DAVIDSON

Softail 1580 Injection		240025	H-D 1	1573,-	1966:-
Touring Twin cam 1584		240025	H-D 1	1573,-	1966:-

HONDA

CBR 125 R		240002	HO 7	1573,-	1966:-
Silver Wing 400		240002	HO 7	1573,-	1966:-
RC 45		240002	HO 7	1573,-	1966:-
CBF 600 N		240002	HO 7	1573,-	1966:-
CBF 600 S		240002	HO 7	1573,-	1966:-
CBR 600 F Sport		240002	HO 7	1573,-	1966:-
CBR 600 F4 i		240002	HO 7	1573,-	1966:-
CBR 600 RR		240002	HO 7	1573,-	1966:-
Hornet 600		240002	HO 7	1573,-	1966:-
Hornet 600 - ABS		240002	HO 7	1573,-	1966:-
Deauville 700		240002	HO 7	1573,-	1966:-
Silver Wing 600		240002	HO 7	1573,-	1966:-
PAN EUROAN 700		240002	HO 7	1573,-	1966:-
Transalp 700		240002	HO 7	1573,-	1966:-
VFR 800		240002	HO 7	1573,-	1966:-
VFR 800 V-TEC		240002	HO 7	1573,-	1966:-
Hornet 900		240002	HO 7	1573,-	1966:-
CBR 929 RR		240002	HO 7	1573,-	1966:-
CBR 954 RR		240002	HO 7	1573,-	1966:-
CB 1000 R		240002	HO 7	1573,-	1966:-
CBF 1000		240002	HO 7	1573,-	1966:-
CBR 1000 RR		240002	HO 7	1573,-	1966:-
Varadero XL1000V		240002	HO 7	1573,-	1966:-
VTR 1000 SP1		240002	HO 7	1573,-	1966:-
VTR 1000 SP2		240002	HO 7	1573,-	1966:-
DN-01		240002	HO 7	1573,-	1966:-
CBR 1100 XX		240002	HO 7	1573,-	1966:-
X11		240002	HO 7	1573,-	1966:-
VFR 1200 F		240002	HO 7	1573,-	1966:-
CB 1300		240002	HO 7	1573,-	1966:-
PAN EUROAN 1300		240002	HO 7	1573,-	1966:-
Rancher		240002	HO 7	1573,-	1966:-
VTX 1800 Retro		240002	HO 7	1573,-	1966:-
VTX 1800 Retro - Neo		240002	HO 7	1573,-	1966:-
VTX 1800 C		240002	HO 7	1573,-	1966:-

HUSQVARNA

TE 250	08-09	240003	HUS 13	1573,-	1966:-
TE 450	08-09	240003	HUS 13	1573,-	1966:-
TE 510	08-09	240003	HUS 13	1573,-	1966:-
TE 610	07-09	240003	HUS 13	1573,-	1966:-
SM450		240003	HUS 13	1573,-	1966:-
SM510		240003	HUS 13	1573,-	1966:-
SM610		240003	HUS 13	1573,-	1966:-

HYOSUNG

MS3 250	07-08	240028	HYOSUNG 3	1573,-	1966:-
GT 250 Naked	07-11	240028	HYOSUNG 3	1573,-	1966:-
GT 250R	07-11	240028	HYOSUNG 3	1573,-	1966:-
Aquila GV 250	08-11	240028	HYOSUNG 3	1573,-	1966:-
GT 650R	08-11	240029	HYOSUNG 8	1573,-	1966:-
GT 650 Naked	08-11	240029	HYOSUNG 8	1573,-	1966:-
Aquila 650	07-11	240029	HYOSUNG 8	1573,-	1966:-

KAWASAKI

Ninja 250	08-10	240022	KAWA 8	1573,-	1966:-
KVF brute force	08-09	240022	KAWA 8	1573,-	1966:-
KLX 250	09	240022	KAWA 8	1573,-	1966:-
KLE versis	07-08	240022	KAWA 8	1573,-	1966:-
ER 6 n/f	06-09	240022	KAWA 8	1573,-	1966:-
ZX 6 R	03-06	240022	KAWA 9	1573,-	1966:-
ZX 6 R	09-10	240022	KAWA 8	1573,-	1966:-
ZX 636	03-06	240022	KAWA 9	1573,-	1966:-
Z 750	04-10	240022	KAWA 9	1573,-	1966:-
Z 750 S Semicarenata		240022	KAWA 9	1573,-	1966:-
VN 900	06-09	240022	KAWA 8	1573,-	1966:-
Vulcan 900		240042	KAWA 14	1573,-	1966:-
Z 1000	03-10	240022	KAWA 9	1573,-	1966:-
ZX 10 R	08-10	240022	KAWA 8	1573,-	1966:-
ZX 10 R	04-07	240022	KAWA 9	1573,-	1966:-
ZX 10 R	04-07	240022	KAWA 9	1573,-	1966:-
KLV 1000		240042	KAWA 14	1573,-	1966:-
Mean Streak		240042	KAWA 14	1573,-	1966:-
ZX 12 R	00-06	240023	KAWA 10	1573,-	1966:-
GTR 1400	08-10	240022	KAWA 9	1573,-	1966:-
ZZR 1400	06-08	240022	KAWA 9	1573,-	1966:-

- Stikord Sökord s. 2-5
- Forhandlere Aterförsäljare s. 6-9
- Töj/hjelme Kläder/hjälm s. 11
- Däck Däck s. 83
- Olie Olja s. 115
- Kæde/tandhjul Kedjor/drev s. 145
- Bremser Broms s. 187
- Låse Lås s. 347
- Batteri Batterier s. 355
- Pakningar Packningar s. 377
- Motordele Motordelar s. 411
- Lejer Lager s. 435
- Karburator Förgasare s. 467
- El-dele/Tænding Elektriskt/Tænding s. 509
- Blinklygter Baglygter Belysning Baklygter s. 611
- Lyddæmper Avgassystem s. 651
- Støddæmper Støtdåmpare s. 681
- Luft/oliefilter Luft/oljefilter s. 711
- Kobling Koppling s. 769
- Kabler Wire s. 803
- Styr/greb Styre/handtag s. 829
- Spejle og diverse Speglar och diverse s. 867
- Bøjer/væktoj Bøker/verktøj s. 893

MemJet indsprøjtningssmodul
MemJet insprøjtningssmodul



Mærke/Model	Prod. Årg.	Varenr.	Ref.nr.		
-------------	------------	---------	---------	--	--

Mærke/Modell	Prod. Årg.	Art.nr.	Ref.nr.	DKK	SEK
--------------	------------	---------	---------	-----	-----

KAWASAKI

VN 1500 Drifter		240042	KAWA 14	1573,-	1966:-
VN 1500 Nomad		240042	KAWA 14	1573,-	1966:-
VN 1500 Vulcan Classic		240042	KAWA 14	1573,-	1966:-
Mean Streak 1600		240042	KAWA 14	1573,-	1966:-
Nomad 1600		240042	KAWA 14	1573,-	1966:-
VN 1600	99-07	240042	KAWA 14	1573,-	1966:-
VN 2000	08-10	240022	KAWA 8	1573,-	1966:-
Vulcan 2000		240042	KAWA 14	1573,-	1966:-

KTM

DUKE 690		240039	KTM 10	1573,-	1966:-
SM 690		240039	KTM 10	1573,-	1966:-
SMC 690		240039	KTM 10	1573,-	1966:-
ADVENTURE 990		240038	KTM 7	1573,-	1966:-
ADVENTURE 990 S		240038	KTM 7	1573,-	1966:-
SUPER DUKE 990		240038	KTM 7	1573,-	1966:-
SUPERMONO 990		240038	KTM 7	1573,-	1966:-

MOTO GUZZI

BELLAGIO	Alle	240021	M-G 1	1573,-	1966:-
CALIFORNIA		240021	M-G 1	1573,-	1966:-
GRISO	Alle	240021	M-G 1	1573,-	1966:-
NEVADA		240021	M-G 1	1573,-	1966:-
NORGE ie		240021	M-G 1	1573,-	1966:-
SPORT	Alle	240021	M-G 1	1573,-	1966:-
STELVIO		240021	M-G 1	1573,-	1966:-
V7 ie		240021	M-G 1	1573,-	1966:-
BREVA 750 IE		240021	M-G 1	1573,-	1966:-
CENTAURO 1000		240021	M-G 1	1573,-	1966:-
QUOTA 1000		240021	M-G 1	1573,-	1966:-
Centauro 1000 4V		240021	M-G 1	1573,-	1966:-
California 1100 IE		240021	M-G 1	1573,-	1966:-
Quota 1100 ES		240021	M-G 1	1573,-	1966:-
V11		240021	M-G 1	1573,-	1966:-
BREVA 1200		240021	M-G 1	1573,-	1966:-

SUZUKI

BURGMAN 125	07-10	240043	SUZ 13	1573,-	1966:-
DR SM 125	09-10	240043	SUZ 13	1573,-	1966:-
GZ Marauder 125	08-10	240043	SUZ 13	1573,-	1966:-
RV Van Van125	08-10	240043	SUZ 13	1573,-	1966:-
BURGMAN 250 IE	03-06	240005	SUZ 7	1573,-	1966:-
BURGMAN 400 IE	03-10	240005	SUZ 7	1573,-	1966:-
GSR 600	06-09	240032	SUZ 11	1573,-	1966:-
GSX R 600	01-05	240032	SUZ 11	1573,-	1966:-
GSX R 600	06-07	240031	SUZ 9	1573,-	1966:-
GSX R 600/750	08-10	240005	SUZ 7	1573,-	1966:-
BURGMAN 650	03-09	240032	SUZ 11	1573,-	1966:-
GSX 650 F	08-10	240043	SUZ 13	1573,-	1966:-
SV 650	03-06	240032	SUZ 11	1573,-	1966:-
V strom 650	04-06	240032	SUZ 11	1573,-	1966:-
SV 650	07-10	240030	SUZ 8	1573,-	1966:-
SFV 650 GLADIUS	09-10	240030	SUZ 8	1573,-	1966:-
V strom 650	07-10	240030	SUZ 8	1573,-	1966:-
GSX R 750	96-05	240032	SUZ 11	1573,-	1966:-
GSX R 750	06-07	240031	SUZ 9	1573,-	1966:-
Intruder 800	01-10	240030	SUZ 8	1573,-	1966:-
Intruder M 800	06-10	240043	SUZ 13	1573,-	1966:-
GSX R 1000	09-10	240005	SUZ 7	1573,-	1966:-
GSX R 1000	07-08	240005	SUZ 7	1573,-	1966:-
GSX R 1000	01-06	240032	SUZ 11	1573,-	1966:-
SV 1000 N/S	03-07	240032	SUZ 11	1573,-	1966:-
TL 1000 R/S	97-01	240032	SUZ 11	1573,-	1966:-
V strom 1000	02-09	240032	SUZ 11	1573,-	1966:-
Bandit 1250 S		240043	SUZ 13	1573,-	1966:-
B KING 1300	08-09	240031	SUZ 9	1573,-	1966:-
HAYABUSA 1300	00-07	240032	SUZ 11	1573,-	1966:-
HAYABUSA 1300	08-10	240005	SUZ 7	1573,-	1966:-
GSX 1400	02-07	240032	SUZ 11	1573,-	1966:-
Intruder 1500	05-08	240032	SUZ 11	1573,-	1966:-
Marauder VZ 1600		240044	SUZ 14	1573,-	1966:-
VZ r/n 1800	06-09	240032	SUZ 11	1573,-	1966:-

Mærke/Model	Prod. Årg.	Varenr.	Ref.nr.		
-------------	------------	---------	---------	--	--

Mærke/Modell	Prod. Årg.	Art.nr.	Ref.nr.	DKK	SEK
--------------	------------	---------	---------	-----	-----

TRIUMPH

DAYTONA 600		240033	TR 4	1573,-	1966:-
TT 600		240033	TR 4	1573,-	1966:-
DAYTONA 650		240033	TR 4	1573,-	1966:-
DAYTONA 675		240033	TR 4	1573,-	1966:-
STREET TRIPLE 675		240033	TR 4	1573,-	1966:-
TIGER 885 ie		240033	TR 4	1573,-	1966:-
DAYTONA 955i		240033	TR 4	1573,-	1966:-
SPEED TRIPLE 955		240033	TR 4	1573,-	1966:-
TIGER 955 ie		240033	TR 4	1573,-	1966:-
SPEED TRIPLE 1050		240033	TR 4	1573,-	1966:-
Sprint ST 1050		240033	TR 4	1573,-	1966:-
TIGER 1050		240033	TR 4	1573,-	1966:-
BONNEVILLE 08		240034	TR 8	1573,-	1966:-
ROCKET III		240033	TR 4	1573,-	1966:-
SPEED FOUR		240033	TR 4	1573,-	1966:-
THRUXTON		240034	TR 8	1573,-	1966:-

YAMAHA

RX-MAX 125	06-08	240035	YAMA 9	1573,-	1966:-
YBR 125	10	240045	YAMA 13	1573,-	1966:-
YZF-R 125		240045	YAMA 13	1573,-	1966:-
X-CITY 125	08	240035	YAMA 9	1573,-	1966:-
RX MAX 250	07-08	240035	YAMA 9	1573,-	1966:-
X-CITY 250	07-08	240035	YAMA 9	1573,-	1966:-
WR R /X 250	08	240035	YAMA 9	1573,-	1966:-
MAJESTY 400	04-08	240035	YAMA 9	1573,-	1966:-
T MAX 500	04-10	240035	YAMA 9	1573,-	1966:-
R6	03-05	240035	YAMA 9	1573,-	1966:-
R6	06-10	240006	YAMA 8	1573,-	1966:-
FZ6 / FAZER	04-08	240035	YAMA 9	1573,-	1966:-
FZ6 Fazer S2		240035	YAMA 9	1573,-	1966:-
FZ6 Fazer S2 ABS		240035	YAMA 9	1573,-	1966:-
XJ 6 S/N /DIVERION	09-10	240006	YAMA 8	1573,-	1966:-
XT 660 X/R		240035	YAMA 9	1573,-	1966:-
R7	99-00	240037	YAMA U	1573,-	1966:-
FZ 8-N	11	240006	YAMA 8	1573,-	1966:-
TM 900	Alle	240036	YAMA 11	1573,-	1966:-
XVS 950	09-10	240006	YAMA 8	1573,-	1966:-
FZ1	06-10	240006	YAMA 8	1573,-	1966:-
FZ1 Fazer		240006	YAMA 8	1573,-	1966:-
FZ1 Naked		240006	YAMA 8	1573,-	1966:-
R1	02-03	240046	YAMA 14	1573,-	1966:-
R1	04-06	240035	YAMA 9	1573,-	1966:-
R1	07-10	240006	YAMA 8	1573,-	1966:-
MT 01	05-07	240006	YAMA 8	1573,-	1966:-
MT 03	06-08	240035	YAMA 9	1573,-	1966:-
XTZ Supertener 1200	10	240006	YAMA 8	1573,-	1966:-
FJR 1300		240046	YAMA 14	1573,-	1966:-
FJR 1300	01-08	240037	YAMA U	1573,-	1966:-
XJR 1300	07-09	240006	YAMA 8	1573,-	1966:-
XV 1300		240006	YAMA 8	1573,-	1966:-
XVS 1300	07-09	240006	YAMA 8	1573,-	1966:-
XT R/X/Z	04-08	240035	YAMA 9	1573,-	1966:-
V MAX 1700	09-10	240006	YAMA 8	1573,-	1966:-
Road Star Warrior		240006	YAMA 8	1573,-	1966:-
Stratoliner Midnight Star		240006	YAMA 8	1573,-	1966:-
XV 1900	06-09	240006	YAMA 8	1573,-	1966:-



Frigears-indikator
Neutral läges givare

Märke/ modell	Prod. årg.	Frigears-indikator Varenr. Ref.nr.	Prod. årg.	Neutral läges givare Art.nr. Ref.nr.	DKK	SEK
HONDA						
NSR 125 R	89-00	099072 NUS-103	113,	141:-		
VT 125 C	99-06	099073 NUS-104	113,	141:-		
VT 125 C2	00-01	099073 NUS-104	113,	141:-		
XL 125 V	01-06	099073 NUS-104	113,	141:-		
FL 400 R	89-90	099074 NUS-105	113,	141:-		
NV 400 C	95	099070 NUS-101	126,	158:-		
NV 400 C	97	099070 NUS-101	126,	158:-		
VFR 400 R3	90-91	099071 NUS-102	113,	141:-		
CB 500 R	94	099071 NUS-102	113,	141:-		
CB 500 R	96-00	099071 NUS-102	113,	141:-		
CB 500	02	099071 NUS-102	113,	141:-		
CB 500 S	98-00	099071 NUS-102	113,	141:-		
CBF 500	04-06	099071 NUS-102	113,	141:-		
CBF 500 A	04-06	099071 NUS-102	113,	141:-		
CBR 500 F	87-91	099072 NUS-103	113,	141:-		
NX 500	89	099071 NUS-102	113,	141:-		
NX 500	90-99	099073 NUS-104	113,	141:-		
CB 600 F	98-06	099071 NUS-102	113,	141:-		
CB 600 F2	00-02	099071 NUS-102	113,	141:-		
CBF 600 N	04-06	099071 NUS-102	113,	141:-		
CBF 600 NA	04-06	099071 NUS-102	113,	141:-		
CBF 600 S	04-06	099071 NUS-102	113,	141:-		
CBF 600 SA	04-06	099071 NUS-102	113,	141:-		
CBR 600 F	87-90	099072 NUS-103	113,	141:-		
CBR 600 F	91-00	099071 NUS-102	113,	141:-		
CBR 600 F	01-06	099071 NUS-102	113,	141:-		
CBR 600 F2	91-94	099071 NUS-102	113,	141:-		
CBR 600 F3	95-98	099071 NUS-102	113,	141:-		
CBR 600 F4	99-03	099071 NUS-102	113,	141:-		
CBR 600 FR	01-02	099071 NUS-102	113,	141:-		
CBR 600 FS	01-02	099071 NUS-102	113,	141:-		
CBR 600 RR	03-06	099071 NUS-102	113,	141:-		
CBR 600 SE	96-98	099071 NUS-102	113,	141:-		
NTV 600	88-90	099070 NUS-101	126,	158:-		
NV 600 C	93-94	099070 NUS-101	126,	158:-		
VT 600 C	89-99	099070 NUS-101	126,	158:-		
VT 600 CD	93-99	099070 NUS-101	126,	158:-		
VT 600 CD2	99	099070 NUS-101	126,	158:-		
XL 600 V	89-06	099070 NUS-101	126,	158:-		
FMX 650	05-06	099073 NUS-104	113,	141:-		
FX 650	99-00	099073 NUS-104	113,	141:-		
NTV 650	88-97	099070 NUS-101	126,	158:-		
NTV 650 V	98-00	099070 NUS-101	126,	158:-		
NX 650	88-89	099071 NUS-102	113,	141:-		
NX 650	89-99	099073 NUS-104	113,	141:-		
SLr 650	97-98	099073 NUS-104	113,	141:-		
NV 750 C2	01-02	099070 NUS-101	126,	158:-		
RVF 750 R	94-05	099071 NUS-102	113,	141:-		
VF 750 C	93-02	099071 NUS-102	113,	141:-		
VF 750 C2	97-00	099071 NUS-102	113,	141:-		
VF 750 CD	95-96	099071 NUS-102	113,	141:-		
VFR 750 F	87	099071 NUS-102	113,	141:-		
VFR 750 F	94-97	099071 NUS-102	113,	141:-		
VT 750 C	97-06	099070 NUS-101	126,	158:-		
VT 750 C2	97-01	099070 NUS-101	126,	158:-		
VT 750 C3	00-01	099070 NUS-101	126,	158:-		
VT 750 CA	05-06	099070 NUS-101	126,	158:-		
VT 750 CA/CB	03	099070 NUS-101	126,	158:-		
VT 750 CD	01-02	099070 NUS-101	126,	158:-		
VT 750 CD3	00-01	099070 NUS-101	126,	158:-		
XRV 750	90-95	099070 NUS-101	126,	158:-		
XRV 750	96-00	099070 NUS-101	126,	158:-		
VFR 800 Fi	99-01	099071 NUS-102	113,	141:-		
VFR 800	02-06	099071 NUS-102	113,	141:-		
VFR 800 A	02-06	099071 NUS-102	113,	141:-		
CB 900 F	02-05	099071 NUS-102	113,	141:-		
CBR 900 RE	01	099071 NUS-102	113,	141:-		
CBR 900 RR	92-00	099071 NUS-102	113,	141:-		
CBR 900 RR	01-03	099071 NUS-102	113,	141:-		
CB 1000 F	93-96	099072 NUS-103	113,	141:-		
CB 1000 RR	04-06	099074 NUS-105	113,	141:-		

Märke/ modell	Prod. årg.	Frigears-indikator Varenr. Ref.nr.	Prod. årg.	Neutral läges givare Art.nr. Ref.nr.	DKK	SEK
HONDA						
CBR 1000 F	87-92	099072 NUS-103	113,	141:-		
CBR 1000 F	93-99	099072 NUS-103	113,	141:-		
VTR 1000 F	97-06	099071 NUS-102	113,	141:-		
VTR 1000 SP	00-06	099071 NUS-102	113,	141:-		
XL 1000 V	99-06	099071 NUS-102	113,	141:-		
XL 1000 VA	04-06	099071 NUS-102	113,	141:-		
CB 1100 SF	00-01	099071 NUS-102	113,	141:-		
CBR 1100 XX	97-06	099071 NUS-102	113,	141:-		
ST 1100	94-02	099071 NUS-102	113,	141:-		
ST 1100 A	94-02	099071 NUS-102	113,	141:-		
ST 1100 P	95-96	099071 NUS-102	113,	141:-		
ST 1100 P	02	099071 NUS-102	113,	141:-		
VT 1100 C	94-98	099071 NUS-102	113,	141:-		
VT 1100 C2	95-05	099071 NUS-102	113,	141:-		
VT 1100 C3	98-00	099071 NUS-102	113,	141:-		
VT 1100 D2	99	099071 NUS-102	113,	141:-		
CB 1300	05	099074 NUS-105	113,	141:-		
CB 1300 A	05	099074 NUS-105	113,	141:-		
CB 1300 F	03	099074 NUS-105	113,	141:-		
CB 1300 Fi	03	099074 NUS-105	113,	141:-		
CB 1300 SA	05	099074 NUS-105	113,	141:-		
ST 1300	02-06	099073 NUS-104	113,	141:-		
ST 1300 A	02-06	099073 NUS-104	113,	141:-		
VTX 1300 S	03-06	099071 NUS-102	113,	141:-		
GL 1500	89-90	099072 NUS-103	113,	141:-		
GL 1500	91-98	099072 NUS-103	113,	141:-		
GL 1500 SE	91-00	099072 NUS-103	113,	141:-		
GL 1800 A	01-05	099072 NUS-103	113,	141:-		
GL 1800	06	099072 NUS-103	113,	141:-		
VTX 1800 C	02-04	099071 NUS-102	113,	141:-		
VTX 1800 C1	05	099071 NUS-102	113,	141:-		



- Stikord Sökord s. 2-5
- Forhandlere Aterförsäljare s. 6-9
- Töj/hjelme Kläder/hjälmor s. 11
- Daek Däck s. 83
- Olie Olja s. 115
- Kæde/tandhjul Kedjor/drev s. 145
- Bremser Broms s. 187
- Låse Lås s. 347
- Batteri Batterier s. 355
- Pakninger Packningar s. 377
- Motordele Motordelar s. 411
- Lejer Lager s. 435
- Karburator Förgasare s. 467
- El-dele/ Tænding Elektriskt/Tænding s. 509
- Blinklygter Baglygter Belysning Baklygter s. 611
- Lyddæmper Avgassystem s. 651
- Støddæmper Støtdåmpare s. 681
- Luft-/oliefilter Luft-/oljefilter s. 711
- Kobling Koppling s. 769
- Kabler Wire s. 803
- Styr/greb Styre/handtag s. 829
- Spejle og diverse Speglar och diverse s. 867
- Bøjer/værktøj Bøcker/verktyg s. 893



Kølevæske temperatur føler
Kylvattentemperatur givare

Mærke/ model	Prod. årg.	Kølevæske temp. føler Varenr. Ref.nr.	87,-	109,-
Mærke/ modell	Prod. årg.	Vattentemperatur givare Art.nr. Ref.nr.	DKK	SEK
HONDA				
MTX 125 RWH	87	099050 WTS-101	87,-	109,-
MTX 125 L	90	099050 WTS-101	87,-	109,-
NSR 50 FPR/FS	93-95	099050 WTS-101	87,-	109,-
NSR 50 RV/RW/RX	97-99	099050 WTS-101	87,-	109,-
NSR 50 SK	89	099050 WTS-101	87,-	109,-
NSR 50 SP/SR/SS	93-95	099050 WTS-101	87,-	109,-
CH 125 J-T	88-96	099050 WTS-101	87,-	109,-
CRM 125 R L-R	90-94	099050 WTS-101	87,-	109,-
CRM 125 V/W/X	97-99	099050 WTS-101	87,-	109,-
FES 125 W-2	98-02	099050 WTS-101	87,-	109,-
NSR 125 F J-P	88-93	099050 WTS-101	87,-	109,-
NSR 125 R K-S	89-95	099050 WTS-101	87,-	109,-
NSR 125 R V-1	97-01	099050 WTS-101	87,-	109,-
FES 150 W-2	98-02	099050 WTS-101	87,-	109,-
CN 250 H-M	87-91	099050 WTS-101	87,-	109,-
CN 250 P-X	93-99	099050 WTS-101	87,-	109,-
FES 250 W-2	98-02	099050 WTS-101	87,-	109,-
NSS 250	01-04	099050 WTS-101	87,-	109,-
NSS 250 A	01-04	099050 WTS-101	87,-	109,-
NX 250 J-P	88-93	099050 WTS-101	87,-	109,-
NX 250 2L	90	099050 WTS-101	87,-	109,-
NX 250 2P	93	099050 WTS-101	87,-	109,-
NV 400 CS	95	099050 WTS-101	87,-	109,-
NV 400 CV	97	099050 WTS-101	87,-	109,-
VFR 400 R3L/R3M	90-91	099050 WTS-101	87,-	109,-
CB 500	02	099050 WTS-101	87,-	109,-
CB 500 R	94	099050 WTS-101	87,-	109,-
CB 500 S W-Y	98-00	099050 WTS-101	87,-	109,-
CB 500 S2	02	099050 WTS-101	87,-	109,-
CB 500 T-Y	96-00	099050 WTS-101	87,-	109,-
CBF 500	04	099050 WTS-101	87,-	109,-
CBF 500	06	099050 WTS-101	87,-	109,-
CBF 500 A4	04	099050 WTS-101	87,-	109,-
CBF 500 A6	06	099050 WTS-101	87,-	109,-
CBR 500 F H-M	87-91	099050 WTS-101	87,-	109,-
GL 500 Silverwing	81-82	099051 WTS-102	100,-	125,-
GL 500i Interstate	81-82	099051 WTS-102	100,-	125,-
CB 600 F W-2	98-02	099050 WTS-101	87,-	109,-
CB 600 F2 Y-2	00-02	099050 WTS-101	87,-	109,-
CBR 600 F H-P	87-93	099050 WTS-101	87,-	109,-
CBR 600 F R-Y	94-00	099050 WTS-101	87,-	109,-
CBR 600 FM	91	099050 WTS-101	87,-	109,-
CBR 600 F2 M-R	91-94	099050 WTS-101	87,-	109,-
CBR 600 F4X/F4Y	99-00	099050 WTS-101	87,-	109,-
CBR 600 FS S-W	95-98	099050 WTS-101	87,-	109,-
CBR 600 SET	96	099050 WTS-101	87,-	109,-
CBR 600 SEW	98	099050 WTS-101	87,-	109,-
NTV 600 J/K/L/M	88-91	099050 WTS-101	87,-	109,-
NTV 600 J-V	88-97	099050 WTS-101	87,-	109,-
NV 600 CP/CR	93-94	099050 WTS-101	87,-	109,-
VT 600 C J-S	88-95	099050 WTS-101	87,-	109,-
VT 600 C T-X	96-99	099050 WTS-101	87,-	109,-
VT 600 CD P-X	93-99	099050 WTS-101	87,-	109,-
XL 600 V H-N	87-92	099050 WTS-101	87,-	109,-
XL 600 V P-X	93-99	099050 WTS-101	87,-	109,-
XL 650 V 1-6	01-06	099050 WTS-101	87,-	109,-
XRV 650 J/K	88-89	099050 WTS-101	87,-	109,-

Mærke/ model	Prod. årg.	Kølevæske temp. føler Varenr. Ref.nr.	87,-	109,-
Mærke/ modell	Prod. årg.	Vattentemperatur givare Art.nr. Ref.nr.	DKK	SEK
HONDA				
VF 750 CDT	96	099050 WTS-101	87,-	109,-
VF 750 C P-2	93-02	099050 WTS-101	87,-	109,-
VF 750 C2 V-Y	97-00	099050 WTS-101	87,-	109,-
VFR 750 F H-N	87-92	099050 WTS-101	87,-	109,-
VFR 750 F P-V	93-97	099050 WTS-101	87,-	109,-
VFR 750 RJ/RK	88-89	099050 WTS-101	87,-	109,-
XRV 750 L-Y	90-00	099050 WTS-101	87,-	109,-
PC 800 K/L	89-90	099050 WTS-101	87,-	109,-
CBR 900 RR N-V	92-97	099050 WTS-101	87,-	109,-
CB 1000 FP-T	93-96	099050 WTS-101	87,-	109,-
CBR 1000 F H-N	87-92	099050 WTS-101	87,-	109,-
CBR 1000 F P-X	93-98	099050 WTS-101	87,-	109,-
GL 1000 K Goldwing	75	099051 WTS-102	100,-	125,-
GL 1000 Goldwing	76-79	099051 WTS-102	100,-	125,-
GL 1000 LTD	76	099051 WTS-102	100,-	125,-
VTR 1000 F V-Y	97-00	099050 WTS-101	87,-	109,-
SL 1000 V X-2	99-02	099050 WTS-101	87,-	109,-
CBR 1100 XX V-W	97-98	099050 WTS-101	87,-	109,-
GL 1100 Goldwing	80-83	099051 WTS-102	100,-	125,-
GL 1100 A Aspencade	82	099051 WTS-102	100,-	125,-
GL 1100i Interstate	80-83	099051 WTS-102	100,-	125,-
ST 1100 L-T	90-96	099050 WTS-101	87,-	109,-
ST 1100 V-2	97-02	099050 WTS-101	87,-	109,-
ST 1100 PP	93	099050 WTS-101	87,-	109,-
ST 1100 PS/PT	95-96	099050 WTS-101	87,-	109,-
ST 1100 PY	00	099050 WTS-101	87,-	109,-
ST 1100 A N-V	92-97	099050 WTS-101	87,-	109,-
ST 1100 A W-2	98-02	099050 WTS-101	87,-	109,-
VF 1100 D2X	99	099050 WTS-101	87,-	109,-
VT 1100 C2 S-Y	95-00	099050 WTS-101	87,-	109,-
VT 1100 C2 1-5	01-05	099050 WTS-101	87,-	109,-
VT 1100 C3 W-Y	98-00	099050 WTS-101	87,-	109,-
VT 1100 CH/CJ	87-88	099050 WTS-101	87,-	109,-
VT 1100 C N-W	92-98	099050 WTS-101	87,-	109,-
GL 1200 Goldwing	84	099051 WTS-102	100,-	125,-
GL 1200i Interstate	84-87	099051 WTS-102	100,-	125,-
GL 1200 A Aspencade	84-85	099051 WTS-102	100,-	125,-
GL 1500 A M-Y	91-00	099050 WTS-101	87,-	109,-
GL 1500 CT V-X	97-99	099050 WTS-101	87,-	109,-
GL 1500 CV/CW/CX	97-99	099050 WTS-101	87,-	109,-
GL 1500 J/K/L	88-90	099050 WTS-101	87,-	109,-
GL 1500 SE M-S	91-95	099050 WTS-101	87,-	109,-
GL 1500 SE T-Y	96-00	099050 WTS-101	87,-	109,-

SUZUKI				
TS 125	89-04	099052 WTS-301	113,-	141,-
AN 250	98-02	099052 WTS-301	113,-	141,-
RGV 250 K/L	89-96	099052 WTS-301	113,-	141,-
AN 400	99-02	099052 WTS-301	113,-	141,-
GSX-R 600 W	92-93	099053 WTS-302	113,-	141,-
RF 600 R	93-96	099053 WTS-302	113,-	141,-
VS 600 GL	95-97	099053 WTS-302	113,-	141,-
GSX-R 750 SP	94	099053 WTS-302	113,-	141,-
GSX-R 750 W	92-95	099053 WTS-302	113,-	141,-
VS 800 GL	92-95	099053 WTS-302	113,-	141,-
RF 900 R	94-07	099053 WTS-302	113,-	141,-
GSX-R 1100 W	93-96	099053 WTS-302	113,-	141,-

099050

099051

099052

099053





Blæser kontakt (køler)
Fläkt kontakt (kylar)

Mærke/ model	Prod. årg.	Blæser kontakt Varenr.	Ref.nr.		
Mærke/ modell	Prod. årg.	Fläkt kontakt Art.nr.	Ref.nr.	DKK	SEK
HONDA					
GL 1000 Goldwing	75-79	099080	RFS-501	460,-	575:-
GL 1000 L Goldwing Ltd	76	099080	RFS-501	460,-	575:-
GL 1100 Goldwing	80-83	099080	RFS-501	460,-	575:-
GL 1100 A Goldwing Asp.	82-83	099080	RFS-501	460,-	575:-
GL 1100i Goldwing Interst.	80-83	099080	RFS-501	460,-	575:-
GL 1200 Goldwing	84	099080	RFS-501	460,-	575:-
GL 1200 A Goldwing Asp.	84-87	099080	RFS-501	460,-	575:-
GL 1200i Goldwing Interst.	84-87	099080	RFS-501	460,-	575:-
GL 1200 L Goldwing Ltd	85	099080	RFS-501	460,-	575:-
GL 1200 SEi Goldwing Asp.	86	099080	RFS-501	460,-	575:-

KAWASAKI					
KLF 400 B1-B7 Boyou 4x4	93-99	099083	RFS-507	460,-	575:-
KVF 400 A1 Prairie 4x4	97	099083	RFS-507	460,-	575:-
KVF 400 B1 Prairie	98	099083	RFS-507	460,-	575:-
KVF 400 C1-C4 Prairie	99-02	099083	RFS-507	460,-	575:-
KVF 400 D1-D4 Prairie	99-02	099083	RFS-507	460,-	575:-
ZX 600 B1H/2H Ninja	04-05	099081	RFS-504	219,-	274:-
ZX 600 D1-D4 Ninja ZX-6	90-03	099083	RFS-507	460,-	575:-
ZX 600 E1-E8 Ninja ZX-6	93-00	099083	RFS-507	460,-	575:-
ZX 600 E-9-E10 Ninja ZX-6	01-02	099083	RFS-507	460,-	575:-
ZX 600 E11 ZZR	03	099083	RFS-507	460,-	575:-
ZX 600 E12H/E13H ZZR	04-05	099083	RFS-507	460,-	575:-
ZX 600 E6F ZZR	06	099083	RFS-507	460,-	575:-
ZX 600 K1H Ninja	03	099081	RFS-504	219,-	274:-
ZX 600 MiH Ninja	04	099081	RFS-504	219,-	274:-
ZX 636 B1/B2 Ninja ZX-6R	03-04	099081	RFS-504	219,-	274:-
KVF 650 A1/A2 Prairie 4x4	02-03	099083	RFS-507	460,-	575:-
KVF 650 B2 Prairie 4x4 Adv.	03	099083	RFS-507	460,-	575:-
KVF 650 D1 Brute Force 4x4	05	099083	RFS-507	460,-	575:-
KVF 650 D7F Brute Force 4x4	07	099083	RFS-507	460,-	575:-
KVF 650 E1 Brute Force 4x4	05	099083	RFS-507	460,-	575:-
KVF 650 E6F Brute Force 4x4	06	099083	RFS-507	460,-	575:-
KVF 650 F6F Brute Force 4x4i	06	099083	RFS-507	460,-	575:-
KSF 700 A1 V-Force KFX700	04	099083	RFS-507	460,-	575:-
KSF 700 A2 KFX700	05	099083	RFS-507	460,-	575:-
KSF 700 A6F KFX700	06	099083	RFS-507	460,-	575:-
KSF 00 A7F KFX700	07	099083	RFS-507	460,-	575:-
KVF 700 A1 Prairie 4x4	04	099083	RFS-507	460,-	575:-
KVF 700 A6F Prairie 4x4	06	099083	RFS-507	460,-	575:-
KVF 700 B1 Prairie 4x4 Hardw	04	099083	RFS-507	460,-	575:-
KVF 700 D6F Prairie 4x4 T.G.	06	099083	RFS-507	460,-	575:-
KVF 750 A1 Brute Force 4x4i	05	099083	RFS-507	460,-	575:-
KVF 750 A6F Brute Force 4x4i	06	099083	RFS-507	460,-	575:-
KVF 750 A7F Brute Force 4x4	07	099083	RFS-507	460,-	575:-
KVF 750 B1 Brute Force 4x4i	05	099083	RFS-507	460,-	575:-
KVF 750 B6F Brute Force 4x4i	06	099083	RFS-507	460,-	575:-
ZR 750 J1H/J2H Z750	04-05	099081	RFS-504	219,-	274:-
ZR 750 J6F Z750S	06	099081	RFS-504	219,-	274:-
ZR 750 K6F Z750S	06	099081	RFS-504	219,-	274:-
ZX 750 H1/H2 Ninja ZX-7	89-90	099083	RFS-507	460,-	575:-
ZX 750 J1/J2 Ninja ZX-7	91-92	099083	RFS-507	460,-	575:-
ZX 750 L1-L3 Ninja ZX-7	93-95	099083	RFS-507	460,-	575:-
ZX 750 K1 Ninja ZX-7R	91	099083	RFS-507	460,-	575:-
ZX 750 M1/M2 Ninja ZX-/R	93-94	099083	RFS-507	460,-	575:-
ZX 750 N1-N3 Ninja ZX-7RR	96-98	099083	RFS-507	460,-	575:-
ZX 750 P1-P8 Ninja ZX-7R	96-98	099083	RFS-507	460,-	575:-
VN 800 A1-A10 Vulcan	95-04	099083	RFS-507	460,-	575:-
VN 800 B1-B8 Vulcan Clas.	96-03	099083	RFS-507	460,-	575:-
VN 800 B9P/B10P Vulcan Cl.	04-05	099083	RFS-507	460,-	575:-
ZX 900 B1-B4 Ninja ZX-7R	94-97	099083	RFS-507	460,-	575:-
ZG 1000 A1-A10 Concours	86-95	099083	RFS-507	460,-	575:-
ZG 1000 A11-A18 Concours	96-03	099083	RFS-507	460,-	575:-
ZR 1000 A1H/A2H/A3H Z1000	03-05	099081	RFS-504	219,-	274:-
ZR 1000 A6F Z1000	06	099081	RFS-504	219,-	274:-
ZX 1000 B1-B3 Ninja ZX-10	88-90	099083	RFS-507	460,-	575:-
ZX 1100 C1-C4 Ninja ZX-11	90-93	099083	RFS-507	460,-	575:-
ZX 1100 D1-D9 Ninja ZX-11	93-01	099083	RFS-507	460,-	575:-
ZX 1200 B1H/B4H Ninja	02-05	099081	RFS-504	219,-	274:-
ZX 1200 B6F Ninja ZX-12R	06	099081	RFS-504	219,-	274:-
ZX 1200 C1H/C2H ZZR1200	02-03	099081	RFS-504	219,-	274:-
ZX 1200 C3/C4 ZZR	04-05	099081	RFS-504	219,-	274:-



Mærke/ model	Prod. årg.	Blæser kontakt Varenr.	Ref.nr.		
Mærke/ modell	Prod. årg.	Fläkt kontakt Art.nr.	Ref.nr.	DKK	SEK
SUZUKI					
AN 250 K3-K6 Burgman	03-06	099081	RFS-504	219,-	274:-
AN 250 W-K2 Burgman	98-02	099082	RFS-505	219,-	274:-
AN 400 K3-K7 Burgman	03-07	099081	RFS-504	219,-	274:-
LT-Z 400 K3-K7 Quad Sport	03-07	099084	RFS-508	219,-	274:-
LT-A 450 X King Quad	07	099085	RFS-509	219,-	274:-
LT-A 500 FY/FK1 Quad Mast.	00-01	099084	RFS-508	219,-	274:-
LT-A 500 FK2-FK6 Vinson 4WD	02-07	099084	RFS-508	219,-	274:-
LT-A 500 K5 Vinson auto	05	099084	RFS-508	219,-	274:-
LT-F 500 FW-FK1 Quad Mast.	98-01	099084	RFS-508	219,-	274:-
LT-F 500 FK2-FK6 Vinson 4WD	02-06	099084	RFS-508	219,-	274:-
LT-F 500 K5 Vinson man. 4WD	07	099084	RFS-508	219,-	274:-
GSX-R 600 T/V/W/X/Y	96-00	099082	RFS-505	219,-	274:-
GSX-R 600 K1-K5	01-05	099082	RFS-505	219,-	274:-
AN 650 K3-K6 Burgman	03-06	099081	RFS-504	219,-	274:-
DL 650 K4-K7 V-Strom	04-07	099081	RFS-504	219,-	274:-
SV 650 K3-K6	03-06	099081	RFS-504	219,-	274:-
LT-A 700 X King Quad	05-07	099085	RFS-509	219,-	274:-
GSX-R 750 T/V/W/Y	96-99	099082	RFS-505	219,-	274:-
GSX-R 750 Y K1/K2/K3	00-03	099082	RFS-505	219,-	274:-
GSX-R 750 K4/K5	04-05	099082	RFS-505	219,-	274:-
VL 800 C-K6 Intruder	06	099082	RFS-505	219,-	274:-
VL 800 K1-K5 Intr. Volusia	01-05	099082	RFS-505	219,-	274:-
VZ 1000 RW/RX/R5	05-07	099082	RFS-505	219,-	274:-
DL 1000 K2-K6 V-Strom	02-06	099082	RFS-505	219,-	274:-
GSX-R 1000 K1/K2/K3/K4	01-04	099082	RFS-505	219,-	274:-
SV 1000 K3/K4/K5	03-05	099082	RFS-505	219,-	274:-
TL 1000 RW/RX/R5	98-00	099082	RFS-505	219,-	274:-
TL 1000 SV/SW/SX/SY/SK1	97-01	099082	RFS-505	219,-	274:-
GSX 1300 RX/R5/K1-K3 Hay.	99-03	099082	RFS-505	219,-	274:-
GSX 1300 RK4-RK6 Hayabusa	04-06	099082	RFS-505	219,-	274:-

- Stikord Sökord s. 2-5
- Forhandlere Aterforsäljare s. 6-9
- Tøj/hjelme Klæder/hjälmar s. 11
- Dæk Däck s. 83
- Oljeolja s. 115
- Kæde/tandhjul Kedjor/drev s. 145
- Bremser Broms s. 187
- Låse Lås s. 347
- Batteri Batterier s. 355
- Pakninger Packningar s. 377
- Motordele Motordelar s. 411
- Lejer Lager s. 435
- Karburator Förgasare s. 467
- El-dele/Tænding Elektriskt/Tänding s. 509
- Blinklygter Baglygter Belysning Baklykter s. 611
- Lyddæmper Avgassystem s. 651
- Støddæmper Støtdämpare s. 681
- Luft/oliefilter Luft/oljefilter s. 711
- Kobling Koppling s. 769
- Kabler Wire s. 803
- Styr/greb Styre/handtag s. 829
- Spejle og diverse Speglar och diverse s. 867
- Bøger/værktøj Böcker/verktyg s. 893

Silicone rectifier
Silicone rectifier



Mærke/ model	Prod. årg.	Silicone rectifier Varenr.	Ref.nr.		
Mærke/ modell	Prod. årg.	Silicone rectifier Art.nr.	Ref.nr.	DKK	SEK

HONDA

GL 500 Silver Wing	81-82	099040	Rec-101	62,-	78,-
GL 500 I Silverwing	81-82	099040	Rec-101	62,-	78,-
VF 500 F Interceptor	84-86	099040	Rec-101	62,-	78,-
CB 550 F	76-77	099040	Rec-101	62,-	78,-
CB 550 K	77-78	099040	Rec-101	62,-	78,-
CB 550 SC Nighthawk	83	099040	Rec-101	62,-	78,-
CBR 600 F2	91	099041	Rec-103	62,-	78,-
VT 600 C Shadow	88-89	099040	Rec-101	62,-	78,-
VT 600 C Shadow	91-94	099041	Rec-103	62,-	78,-
VT 600 C Shadow VLX	95-97	099041	Rec-103	62,-	78,-
VT 600 CD Shadow DeLuxe	93-94	099041	Rec-103	62,-	78,-
VT 600 CD Shadow VLX DeLuxe	95-98	099041	Rec-103	62,-	78,-
CB 650	79	099040	Rec-101	62,-	78,-
CB 650 SC	83-85	099040	Rec-101	62,-	78,-
CX 650 T Turbo	83	099040	Rec-101	62,-	78,-
GL 650 Silverwing	83	099040	Rec-101	62,-	78,-
GL 650 I Silverwing	83	099040	Rec-101	62,-	78,-
NT 650 Hawk GT	88-91	099040	Rec-101	62,-	78,-
CB 700 SC	84-86	099040	Rec-101	62,-	78,-
VF 700 F Interceptor	84-85	099040	Rec-101	62,-	78,-
VF 700 C Magna	84-86	099040	Rec-101	62,-	78,-
VF 700 S Sabre	84-85	099040	Rec-101	62,-	78,-
VFR 700 F Interceptor	86	099040	Rec-101	62,-	78,-
VFR 700 F2 Interceptor	86-87	099040	Rec-101	62,-	78,-
VFR 700 F Interceptor	86-87	099040	Rec-101	62,-	78,-
VT 700 C Shadow	84-87	099040	Rec-101	62,-	78,-
CB 750 SC	82-83	099040	Rec-101	62,-	78,-
CB 750 K	76-82	099040	Rec-101	62,-	78,-
CB 750 L	79	099040	Rec-101	62,-	78,-
CB 750 C Custom	80-82	099040	Rec-101	62,-	78,-
CB 750 F Supersport	77-82	099040	Rec-101	62,-	78,-
CB 750 Nighthawk	91-96	099041	Rec-103	62,-	78,-
VF 750 C Magna	82-83	099040	Rec-101	62,-	78,-
VF 750 C Magna	88	099040	Rec-101	62,-	78,-
VF 750 C Magna	94-00	099041	Rec-103	62,-	78,-
VF 750 CD Magna DeLuxe	95-96	099041	Rec-103	62,-	78,-
VF 750 C2 Magna DeLuxe	98-00	099041	Rec-103	62,-	78,-
VF 750 S Sabre	82-83	099040	Rec-101	62,-	78,-
VF 750 F Interceptor	83-84	099040	Rec-101	62,-	78,-
VFR 750 F Interceptor	90-95	099041	Rec-103	62,-	78,-



Mærke/ model	Prod. årg.	Silicone rectifier Varenr.	Ref.nr.		
Mærke/ modell	Prod. årg.	Silicone rectifier Art.nr.	Ref.nr.	DKK	SEK

HONDA

VT 750 C Shadow	83	099040	Rec-101	62,-	78,-
PC 800 Pacific Coast	89	099040	Rec-101	62,-	78,-
PC 800 Pacific Coast	90	099041	Rec-103	62,-	78,-
PC 800 Pacific Coast	94-96	099041	Rec-103	62,-	78,-
VT 800 C Shadow	88	099040	Rec-101	62,-	78,-
CB 900 C Custom	80-82	099040	Rec-101	62,-	78,-
CB 900 F Super Sport	81-82	099040	Rec-101	62,-	78,-
CBR 900 RR	93-95	099041	Rec-103	62,-	78,-
CB 1000 C Custom	83	099040	Rec-101	62,-	78,-
CB 1000	94-95	099041	Rec-103	62,-	78,-
CBR 1000 F	87-88	099040	Rec-101	62,-	78,-
CBR 1000 F	90-95	099041	Rec-103	62,-	78,-
CB 1100 F	83	099040	Rec-101	62,-	78,-
CBX Super Sport	81-82	099040	Rec-101	62,-	78,-
ST 1100	95-00	099041	Rec-103	62,-	78,-
ST 1100 A	95-00	099041	Rec-103	62,-	78,-
VF 1100 S Sabre	84-85	099040	Rec-101	62,-	78,-
VF 1100 C Custom	83-86	099040	Rec-101	62,-	78,-
VF 1100 F Interceptor	84	099040	Rec-101	62,-	78,-
VF 1100 R	85-86	099040	Rec-101	62,-	78,-
VT 1100 C Shadow	85-96	099040	Rec-101	62,-	78,-
VT 1100 C Shadow Spirit	95-00	099041	Rec-103	62,-	78,-
VT 1100 C2 Shadow American	95-99	099041	Rec-103	62,-	78,-
VT 1100 C2 Shadow American	95-96	099040	Rec-101	62,-	78,-
VT 1100 C3 Shadow Aero	98-00	099041	Rec-103	62,-	78,-
VT 1100 D2 Shadow American	99	099041	Rec-103	62,-	78,-
VT 1100 T Shadow American	98-00	099041	Rec-103	62,-	78,-
GL 1500 Goldwing	88-90	099040	Rec-101	62,-	78,-
GL 1500 SE Goldwing	90-91	099040	Rec-101	62,-	78,-
GL 1500 A Goldwing AS	91	099040	Rec-101	62,-	78,-
GI 1500i Goldwing IN	91	099040	Rec-101	62,-	78,-
GL 1500i Goldwing IN	94-96	099040	Rec-101	62,-	78,-
GL 1500 CF Valkyrie Int.	99-00	099040	Rec-101	62,-	78,-

Han/hun stik
Hane/hone skarvkoppling

Han/hun stik
- til japanske ledningsnet
Sælges i poser med 10 stk.

Hane/hone skarvkoppling
- till japanske ledningsnet
Säljes i påsar om 10 st.

Hunстик med klemme/
hona med klämma. Ref.nr. LGF515-K.
Varenr. 095000 **DKK** **SEK**
Pr. stk. 12,- 15,-



Hanстик med klemme/
hane med klämma.
Ref.nr. LGM515-K.
Varenr. 095001 **DKK** **SEK**
Pr. stk. 12,- 15,-



Han/hun stik
- til japanske ledningsnet
Sælges i poser med 10 stk.

Hane/hone skarvkoppling
- till japanske ledningsnet
Säljes i påsar om 10 st.

Blød, klar plast-isolering/
Mjuk, klar plastisolering.
Ref.nr. LGM515-C-K.
Varenr. 095002 **DKK** **SEK**
Pr. stk. 12,- 15,-



Blød, klar plast-isolering/
Mjuk, klar plastisolering.
Ref.nr. LGF515-C-K.
Varenr. 095003 **DKK** **SEK**
Pr. stk. 12,- 15,-



Sikringer
Säkringar

Sikringer - rund model
Leveres i 10 stk. pakninger

Säkringar - rund modell
Leveras i 10 st. packningar

- | | | | | | |
|--|--|------|--|------|--|
| 25 mm. 7 Amp.
Varenr./art.nr. 094100 | | DKK | | SEK | |
| Pr. stk. | | 12,- | | 15,- | |
| 25 mm. 10 Amp.
Varenr./art.nr. 094101 | | DKK | | SEK | |
| Pr. stk. | | 12,- | | 15,- | |
| 25 mm. 15 Amp.
Varenr./art.nr. 094102 | | DKK | | SEK | |
| Pr. stk. | | 12,- | | 15,- | |
| 25 mm. 20 Amp.
Varenr./art.nr. 094103 | | DKK | | SEK | |
| Pr. stk. | | 12,- | | 15,- | |
| 25 mm. 25 Amp.
Varenr./art.nr. 094104 | | DKK | | SEK | |
| Pr. stk. | | 12,- | | 15,- | |
| 25 mm. 30 Amp.
Varenr./art.nr. 094105 | | DKK | | SEK | |
| Pr. stk. | | 12,- | | 15,- | |

Pladesikringer
Leveres i 10 stk. pakninger

Plattsäkring
Leveras i 10 st. packningar



- | | | | | |
|-----------------------------------|--|------|--|------|
| 3 Amp. Lilla. Ref.nr. 48-05068 | | DKK | | SEK |
| Varenr./art.nr. 010160 - pr. stk. | | 12,- | | 15,- |
| 5 Amp. Orange. Ref.nr. 48-05060 | | | | |
| Varenr./art.nr. 010161 - pr. stk. | | 12,- | | 15,- |
| 7,5 Amp. Brun. Ref.nr. 48-05061 | | | | |
| Varenr./art.nr. 010162 - pr. stk. | | 12,- | | 15,- |
| 10 Amp. Rød. Ref.nr. 48-05062 | | | | |
| Varenr./art.nr. 010163 - pr. stk. | | 12,- | | 15,- |
| 15 Amp. Blå. Ref.nr. 48-05063 | | | | |
| Varenr./art.nr. 010164 - pr. stk. | | 12,- | | 15,- |
| 20 Amp. Gul. Ref.nr. 48-05064 | | | | |
| Varenr./art.nr. 010165 - pr. stk. | | 12,- | | 15,- |
| 25 Amp. Klar. Ref.nr. 48-05065 | | | | |
| Varenr./art.nr. 010166 - pr. stk. | | 12,- | | 15,- |
| 30 Amp. Grøn. Ref.nr. 48-05066 | | | | |
| Varenr./art.nr. 010167 - pr. stk. | | 12,- | | 15,- |

Pladesikringer
Sortiment 100 stk. 10 af hver.
2-3-4-5-7,5-10-15-20-25-30 Amp.

Plattsäkring
Sortiment 100 st.
10 av hver. 2-3-4-5-7,5-10-
15-20-25-30 Amp.

- | | | | | |
|------------------------|--|-------|--|-------|
| Varenr./art.nr. 192125 | | DKK | | SEK |
| En æske/ask | | 201,- | | 251,- |



Universal sikringsholder

Sikringsholder, til eftermontering på ledningsnet, med 30A pladesikring.

Universal säkringshållare

Säkringshållar, till eftermontering på kabel med 30A glas-säkring. Ref.nr. 38-93321.

- | | | | | |
|------------------------|--|------|--|------|
| Varenr./art.nr. 174211 | | DKK | | SEK |
| Pr. stk. | | 37,- | | 46,- |



Universal sikringsholder

Sikringsholder, monteres med 15Ah glas-sikring.

Universal säkringshållare

Säkringshållar, monteret med 15Ah glas-säkring.

- | | | | | |
|------------------------|--|------|--|------|
| Ref.nr. G3-9971. | | | | |
| Varenr./art.nr. 174204 | | DKK | | SEK |
| Pr. stk. | | 37,- | | 46,- |



Sikringer - flad type
Leveres i 10 stk. pakninger

Säkringar - flat modell
Leveras i 10 st. packningar

Alle/alla Honda modeller - 30 Amp. OEM nr. 98200-53000.

- | | | | | |
|------------------------|--|------|--|------|
| Varenr./art.nr. 094000 | | DKK | | SEK |
| Pr. stk. | | 12,- | | 15,- |



Pladesikringer
Leveres i 10 stk. pakninger

Plattsäkring
Leveras i 10 st. packningar

- | | | | | |
|---------------------------|--|------|--|------|
| 5 Amp. Ref.nr. 48-05050 | | | | |
| Varenr./art.nr. 010146 | | DKK | | SEK |
| Pr. stk. | | 12,- | | 15,- |
| 7,5 Amp. Ref.nr. 48-05051 | | | | |
| Varenr./art.nr. 010147 | | DKK | | SEK |
| Pr. stk. | | 12,- | | 15,- |
| 10 Amp. Ref.nr. 48-05052 | | | | |
| Varenr./art.nr. 010148 | | DKK | | SEK |
| Pr. stk. | | 12,- | | 15,- |
| 15 Amp. Ref.nr. 48-05053 | | | | |
| Varenr./art.nr. 010149 | | DKK | | SEK |
| Pr. stk. | | 12,- | | 15,- |
| 20 Amp. Ref.nr. 48-05054 | | | | |
| Varenr./art.nr. 010150 | | DKK | | SEK |
| Pr. stk. | | 12,- | | 15,- |
| 25 Amp. Ref.nr. 48-05055 | | | | |
| Varenr./art.nr. 010151 | | DKK | | SEK |
| Pr. stk. | | 12,- | | 15,- |
| 30 Amp. Ref.nr. 48-05056 | | | | |
| Varenr./art.nr. 010152 | | DKK | | SEK |
| Pr. stk. | | 12,- | | 15,- |



Stikord
Sökord
s. 2-5

Forhandlere
Aterforsäljare
s. 6-9

Tøj/hjelme
Klæder/
hjelmar
s. 11

Dæk
Däck
s. 83

Olie
Olja
s. 115

Kæde/
tandhjul
Kedjor/
drev
s. 145

Bremser
Broms
s. 187

Låse
Lås
s. 347

Batteri
Batterier
s. 355

Pakninger
Packningar
s. 377

Motordele
Motordelar
s. 411

Lejer
Lager
s. 435

Karburator
Förgasare
s. 467

El-dele/
Tænding
Elektrisk/
Tänding
s. 509

Blinklygter
Baglygter
Belysning
Baklykter
s. 611

Lyddæmper
Avgassystem
s. 651

Støddæmper
Støtdåmpare
s. 681

Luft/
oliefilter
Luft/
oljefilter
s. 711

Kobling
Koppling
s. 769

Kabler
Wire
s. 803

Styr/greb
Styre/
handtag
s. 829

Spejle
og diverse
Speglar
och diverse
s. 867

Bøger/
værktøj
Böcker/
verktyg
s. 893

 Starter motor
 Startmotor



**Honda ATC 250 ES/SX
TRX 250/300/300FW**



Ref.nr.: SM3213P
Varenr./art.nr. 174250

 DKK 3148,-  SEK 3935,-



**Honda GL 1000
GL 1100**

Ref.nr.: SM1100P
Varenr./art.nr. 174251

 DKK 3148,-  SEK 3935,-



Honda GL 1200



Ref.nr.: SM1200P
Varenr./art.nr. 174252

 DKK 3358,-  SEK 4198,-



**Suzuki Hayabusa
GSX 1300, GXS 1400**

Ref.nr.: SM1300P
Varenr./art.nr. 174253

 DKK 3148,-  SEK 3935,-



**Yamaha Virago XV 700
XV 750/1000/1100 (86-97)**

Ref.nr.: SM32770
Varenr./art.nr. 174254

 DKK 3358,-  SEK 4198,-



**Yamaha
Virago XV 700
XV 750, XV 920 (81-95)**

Ref.nr.: SM3445P
Varenr./art.nr. 174255

 DKK 3358,-  SEK 4198,-

DKK Blinkrelæer 12 volt
SEK Blinkers-relä 12 volt



DKK EMGO leverer nogle af verdens bedste uoriginale relæer.

EMGO bliver styret fra USA, og kvalitetskontrollen foregår også her. Dette giver dig en uovertruffen kvalitet, fuldt på højde med de originale, så her får du en meget høj kvalitet - til en meget lav pris.

SEK EMGO levererar några av världens bästa u-original reläer.

EMGO International levererar reservelar över hela världen. Koncernens styrning och kvalitetskontroll föregår i USA och har mer än 30 års erfarenhet på alla internationella marknader. Det garanterar dig de bästa produkter till dagens motorcyklar, cross och ATV-maskiner.

HONDA

Til alle Honda gadecykler.
12V/23 W.
OEM nr. 38310-415-671.
Ref.nr. 66-86712.



DKK **SEK**
67,- **84:-**

Varenr./art.nr. 171500

HONDA

Til alle Honda gadecykler,
med 3 ben på relæet.
12 V.
Ref.nr. 66-86782.



DKK **SEK**
56,- **70:-**

Varenr./art.nr. 171514

KAWASAKI

KZ 220, årg. 78-79 -
S1 250, 73-75 -
KH 250, 76 -
KZ 250, 80-83 -
EX 305, 83 -
KZ 305, 81-82/87-88 -
S3 400, 74-75 -
KZ 400, 74-79 -
KZ 400, 80-83 - H1 500, 73-75 - KH 500, 76 - KZ 550, alle - KZ 650, alle - KZ 700, 84 - H2 750, 72-75 - KZ 750, alle 76-84 - KZ 900, 76 - Z1 900, 73-75 - KZ 1000, alle 77-83 - KZ 1100, 81-83 - KZ 1300, 79-82.
12V/10W.
OEM nr. 27002-011.
Ref.nr. 66.86722.



DKK **SEK**
56,- **70:-**

Varenr./art.nr. 171501

KAWASAKI

EL 250, årg. 88 -
EX 250 Ninja, 86-88 -
KL 250, 85-88 -
KZ 550 F2, 84 -
ZX 550, 84-86 -
KL 600 KLR, 84-86 -
KL 600 KLR, 87-88.
12V/23W.
OEM nr. 27002-1053.
Ref.nr. 66.86752



DKK **SEK**
56,- **70:-**

Varenr./art.nr. 171502

SUZUKI

Alle Suzuki gadecykler.
12V/23W.
OEM nr. 38610-31310.



DKK **SEK**
56,- **70:-**

Ref.nr. 66.86752.

Varenr./art.nr. 171502

DKK Elektronisk blinkrelæ

SEK Elektroniskt blinkers relä

Passer på alle 6/12V.
Passar på alla 6/12V.
Ref.nr. 76.86782.



DKK **SEK**
99,- **124:-**

Varenr./art.nr. 171503

DKK Elektronisk blinkrelæ

SEK Elektroniskt blinkers relä

Passer på alle 12V.
Passar på alla 12V.
Ref.nr. 76.86800.



DKK **SEK**
120,- **150:-**

Varenr./art.nr. 171504

Stikord Sökord s. 2-5

Forhandlere Aterforsäljare s. 6-9

Tøj/hjelme Klæder/hjælmar s. 11

Dæk Däck s. 83

Olje Olja s. 115

Kæde/tandhjul Kedjor/drev s. 145

Bremser Broms s. 187

Låse Lås s. 347

Batteri Batterier s. 355

Pakninger Packningar s. 377

Motordele Motordelar s. 411

Lejer Lager s. 435

Karburator Förgasare s. 467

El-dele/ Tænding Elektriskt/ Tänding s. 509

Blinklygter Baglygter Belysning Baklygter s. 611

Lyddæmper Avgassystem s. 651

Støddæmper Støtdämpare s. 681

Luft-/oliefilter Luft-/oljefilter s. 711

Kobling Koppling s. 769

Kabler Wire s. 803

Styr/greb Styre/handtag s. 829

Spejle og diverse Speglar och diverse s. 867

Bøger/værktøj Böcker/verktyg s. 893

Starter-kul
Startmotor-kol

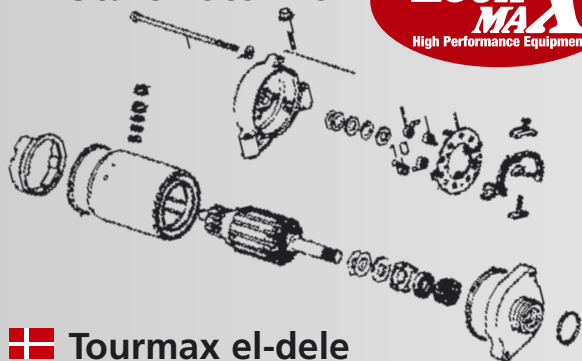

Tourmax el-dele

Alle Tourmax el-dele er produceret med de samme mål og specifikationer, som de originale dele.

Tourmax el-delar

Alla Tourmax eldelar är tillverkade med samma mått och prestanda som originaldelen.

Innen du monterer nye el-dele, bør du kontrollere at alle stik og stel-forbindelser er ok, da du ellers kan ødelægge den nye komponent straks ved montering.

Innan du monterar nye delar ska du vara uppmärksam på att alla kontakter och anslutningar är hela, så att inte dom nya delarna går sönder vid montering.



Mærke/ modell	Type beteg.	Prod. årg.	Starter-kul, 1 stk. Varenr. Ref.nr.	DKK	SEK
------------------	----------------	---------------	--	-----	-----

Mærke/ modell	Type beteg.	Prod. årg.	Startmotor-kol, 1 st. Art.nr. Ref.nr.	DKK	SEK
------------------	----------------	---------------	--	-----	-----

HONDA					
CB 250 N/NA/NB/NC		79-82	099003 CBS-104	107,-	134,-
CB 250 T2		79	099003 CBS-104	107,-	134,-
CB 350 F		73	099003 CBS-104	79,-	134,-
CB 400 A, 2 cyl.		79	099003 CBS-104	107,-	134,-
CB 400 N/NA/NB/NC, 2 cyl.		79-82	099003 CBS-104	107,-	134,-
CB 400 TII, 2 cyl.		78	099003 CBS-104	107,-	134,-
CM 400 T (A/B/C), 2 cyl.	NC01	80-82	099003 CBS-104	107,-	134,-
CB 450 N (F), 2 cyl.	PC14	85	099003 CBS-104	107,-	134,-
CB 450 S(G), 2 cyl.	PC17	86	099003 CBS-104	107,-	134,-
CB 500 F K0-K2, 4 cyl.		70-74	099001 CBS-102	128,-	160,-
CB 500		96-02	099004 CBS-105	201,-	251,-
CX 500 A/B		79-82	099001 CBS-102	128,-	160,-
CX 500 C	PC01	80-82	099001 CBS-102	128,-	160,-
CX 500 E	PC06	79-83	099001 CBS-102	128,-	160,-
CX 500 TC	PC03	79-82	099001 CBS-102	128,-	160,-
GL 500	PC02	82	099001 CBS-102	128,-	160,-
VF 500 F	PC12	84-86	099000 CBS-101	195,-	244,-
VT 500	FT/C	83-86	099000 CBS-101	195,-	244,-
CB 550 F, 4 cyl.		75-76	099001 CBS-102	128,-	160,-
CB 550 K3		76-78	099001 CBS-102	128,-	160,-
CBX 550 F/II	PC04	82	099000 CBS-101	195,-	244,-
CBR 600 F		87-98	099004 CBS-105	201,-	251,-
CB 600 F Hornet		98-05	099004 CBS-105	201,-	251,-
CBF 600 N/S		04-05	099004 CBS-105	201,-	251,-
VT 600 C/J		88-05	099004 CBS-105	201,-	251,-
XL 600 V/H/J	PD06	87-88	099000 CBS-101	195,-	244,-
CB 650	RC03	79-81	099001 CBS-102	128,-	160,-
CB 650 C	RC05	80-81	099001 CBS-102	128,-	160,-
CB 650 SC	RC08	82	099001 CBS-102	128,-	160,-
CX 650 C	RC11	83	099001 CBS-102	128,-	160,-
CX 650 E	RC13	83	099001 CBS-102	128,-	160,-
GL 650 D	RC10	83	099001 CBS-102	128,-	160,-
NTV 650 J		88-97	099004 CBS-105	201,-	251,-
NX 650 J-X Dominator		88-99	099004 CBS-105	201,-	251,-
XRV 650		88	099004 CBS-105	201,-	251,-
VT 700 Shadow		86-87	099000 CBS-101	195,-	244,-
CB 750 C	RC06	81	099001 CBS-102	128,-	160,-
CB 750 F1/F2		77-78	099001 CBS-102	128,-	160,-
CB 750 F A/B/C/F2	RC04	80-82	099001 CBS-102	128,-	160,-
CB 750 K6/K7		76-77	099001 CBS-102	128,-	160,-
CB 750 KZ/KA/KB	RC01	79-81	099001 CBS-102	128,-	160,-
CB 750 Seven Fifty		91-01	099004 CBS-105	201,-	251,-
CBX 750 F	RC17	84-86	099000 CBS-101	195,-	244,-
VF 750 C	RC09	82-84	099000 CBS-101	195,-	244,-
VF 750 F	RC15	83-84	099000 CBS-101	195,-	244,-
VF 750 S	RC07	82-83	099000 CBS-101	195,-	244,-

Mærke/ modell	Type beteg.	Prod. årg.	Starter-kul, 1 stk. Varenr. Ref.nr.	DKK	SEK
------------------	----------------	---------------	--	-----	-----

Mærke/ modell	Type beteg.	Prod. årg.	Startmotor-kol, 1 st. Art.nr. Ref.nr.	DKK	SEK
------------------	----------------	---------------	--	-----	-----

HONDA					
VF 750 C		93-00	099004 CBS-105	201,-	251,-
VT 750 Shadow		86	099000 CBS-101	195,-	244,-
VT 750 Shadow		97-05	099004 CBS-105	201,-	251,-
VFR 750 F	RC24	86-87	099000 CBS-101	195,-	244,-
VFR 750 F		88-97	099004 CBS-105	201,-	251,-
PC 800 Pacific Coast		89-90	099004 CBS-105	201,-	251,-
VFR 800/A		98-05	099004 CBS-105	201,-	251,-
CB 900 F/F2	SC01-09	79-88	099001 CBS-102	128,-	160,-
CB 900 Hornet		02-05	099004 CBS-105	201,-	251,-
CBR 900 RR Fireblade		92-01	099004 CBS-105	201,-	251,-
CB 1000		93-96	099004 CBS-105	201,-	251,-
CBR 1000 F	SC21	87-88	099000 CBS-101	195,-	244,-
CBR 1000 F		90-99	099004 CBS-105	201,-	251,-
CBX 1000, 6 cyl. - SC03/	SC06	79-82	099001 CBS-102	128,-	160,-
VF 1000 F/F2	SC15	84->	099001 CBS-102	128,-	160,-
VF 1000 R	SC16	84-86	099001 CBS-102	128,-	160,-
GL 1000 K1/K2/K3	GL 1/2	75-79	099001 CBS-102	128,-	160,-
VTR 1000 F/SP		98-04	099004 CBS-105	201,-	251,-
CB 1100 F/R - SC11/SC05/	SC08	81-83	099001 CBS-102	128,-	160,-
CB 1100 X-Eleven		00-01	099004 CBS-105	201,-	251,-
CBR 1100 XX Blackbird		97-05	099004 CBS-105	201,-	251,-
GL 1100	SC02	80-83	099001 CBS-102	128,-	160,-
VT 1100 C		85-93	099000 CBS-101	195,-	244,-
VT 1100 Shadow		94-05	099004 CBS-105	201,-	251,-
ST 1100/A Pan European		92-02	099004 CBS-105	201,-	251,-
GL 1200 D	SC14	84-87	099001 CBS-102	128,-	160,-
CB 1300		03-05	099004 CBS-105	201,-	251,-
ST 1300/A Pan European		02-05	099004 CBS-105	201,-	251,-
VTX 1300 S/R/C		03-05	099004 CBS-105	201,-	251,-
GL 1500/I		81-82	099001 CBS-102	128,-	160,-
VTX 1800		02-05	099004 CBS-105	201,-	251,-

KAWASAKI

Z 400 F/B1	ZR400B	84	099000 CBS-101	195,-	244,-
Z 400 GP M1	KZ400M	83	099000 CBS-101	195,-	244,-
Z 400 J1/J2	KZ400J	80-81	099001 CBS-102	128,-	160,-
Z 400 J3	KZ400J	82	099000 CBS-101	195,-	244,-
KZ 440/LTD		81-83	099000 CBS-101	195,-	244,-
EN 450		85	099000 CBS-101	195,-	244,-
EN 500 Vulcan		96-03	099004 CBS-105	201,-	251,-
ER-5		97-01	099004 CBS-105	201,-	251,-
GPZ 500 S A1	EX500A	87-89	099000 CBS-101	195,-	244,-
GPZ 500/S		89-02	099004 CBS-105	201,-	251,-
Z 500 B1, B2	KZ500B	79-80	099001 CBS-102	128,-	160,-
GPZ 550 A1-6	ZX550A	84-89	099000 CBS-101	195,-	244,-
Z 550 B2/B3	KZ550B	81-82	099000 CBS-101	195,-	244,-

Starter-kul
Startmotor-kol



Mærke/ model	Type beteg.	Prod. årg.	Starter-kul, 1 stk. Varenr. Ref.nr.	DKK	SEK
YAMAHA					
XS 250	1U5, 4A2	77-80	099003 CBS-104	107,-	134:-
XS 360		77	099003 CBS-104	107,-	134:-
XS 400	2A2, 4A3	80-81	099003 CBS-104	107,-	134:-
XS 400	2A2, 4A3	82	099000 CBS-101	195,-	244:-
XS 400 SE	4G5	81	099003 CBS-104	107,-	134:-
XS 400 SE	4G5	82	099000 CBS-101	195,-	244:-
XV 535 Virago		90-01	099004 CBS-105	201,-	251:-
XJ 550	4V8, 4V9	27A	81-83 099000 CBS-101	195,-	244:-
FZ 600 S			86-88 099000 CBS-101	195,-	244:-
FZR 600		89-99	099004 CBS-105	201,-	251:-
FZS 600		98-03	099004 CBS-105	201,-	251:-
XJ 600	51J, 51H	84-88	099000 CBS-101	195,-	244:-
XJ 600 H	51J, 3KM1/3/589-91		099000 CBS-101	195,-	244:-
XJ 600 N/S		92-02	099004 CBS-105	201,-	251:-
XT 600 E		91-02	099004 CBS-105	201,-	251:-
YZF 600 R Thundercat		96-02	099004 CBS-105	201,-	251:-
XJ 650 kardan	4K0, 11N, 11R	80-82	099002 CBS-103	195,-	244:-
XJ 650 kardan	4K0, 27G, 27F	82-83	099002 CBS-103	195,-	244:-
XJ 650 T	11T	82	099002 CBS-103	195,-	244:-
XVS 650/A Drag Star		97-05	099004 CBS-105	201,-	251:-
SZR 660		95-97	099004 CBS-105	201,-	251:-
XTZ 660 Tenere		92-96	099004 CBS-105	201,-	251:-
FZR 750 R		90	099004 CBS-105	201,-	251:-
XJ 750 Seca	11M	82-83	099002 CBS-103	195,-	244:-
XJ 750 Maxim	41Y	82-85	099002 CBS-103	195,-	244:-
XS 750	1T5	78-80	099001 CBS-102	128,-	160:-
XS 750 SE	3L3	80	099001 CBS-102	128,-	160:-
XTZ 750 Super Tenere		89-95	099004 CBS-105	201,-	251:-
XV 750 SE Virago	5G5, 5K4	81-89	099001 CBS-102	128,-	160:-
TDM 850		82-01	099004 CBS-105	201,-	251:-

Mærke/ model	Type beteg.	Prod. årg.	Starter-kul, 1 stk. Varenr. Ref.nr.	DKK	SEK
YAMAHA					
XS 850	4E2	80	099001 CBS-102	128,-	160:-
TDM 900		01-05	099004 CBS-105	201,-	251:-
XJ 900	31A, 42N	83-84	099002 CBS-103	195,-	244:-
XJ 900/F	58L, 1FW	85-86	099002 CBS-103	195,-	244:-
XJ 900 F	58L, 2HL	87-88	099002 CBS-103	195,-	244:-
XJ 900 F	58L, 3NG1/2	89-90	099002 CBS-103	195,-	244:-
XJ 900 F	4BB1/2	91-94	099002 CBS-103	195,-	244:-
XJ 900 S Diversion	4KM1/3	95-02	099002 CBS-103	195,-	244:-
XV 920 Virago		81-83	099001 CBS-102	128,-	160:-
FZR 1000 W-G		89-95	099004 CBS-105	201,-	251:-
FZS 1000/FZ 1		01-05	099004 CBS-105	201,-	251:-
XV 1000 / TR1	5A8, 19T	81-82	099001 CBS-102	128,-	160:-
XV 1000 SE Virago	2AE, 3DR1	82-88	099001 CBS-102	128,-	160:-
YZF R1		98-99	099004 CBS-105	201,-	251:-
FJ 1100	47E	84-86	099001 CBS-102	128,-	160:-
XS 1100	2H9, 3X0	80-81	099001 CBS-102	128,-	160:-
XS 1100 S	5K7	81	099001 CBS-102	128,-	160:-
XV 1100 Virago		86-89	099001 CBS-102	128,-	160:-
FJ 1200	1XJ	84-87	099001 CBS-102	128,-	160:-
FJ 1200	3CW1/2	88-90	099001 CBS-102	128,-	160:-
FJ 1200/A		91-97	099004 CBS-105	201,-	251:-
VMX 12 N/C/U, V-MAX		85-92	099001 CBS-102	128,-	160:-
VMX 1200 V-MAX		93-05	099004 CBS-105	201,-	251:-
XJR 1200/SP		95-98	099004 CBS-105	201,-	251:-
XVZ 12 T/TD	47G	84-85	099001 CBS-102	128,-	160:-
XJR 1300/SP		99-04	099004 CBS-105	201,-	251:-
XVZ 1300 Venture/Royal		91-05	099004 CBS-105	201,-	251:-
XVZ 13 Venture/Royal		86-90	099001 CBS-102	128,-	160:-
XV 1600 Road Star		99-02	099004 CBS-105	201,-	251:-
XV 1700 Road Star		04-05	099004 CBS-105	201,-	251:-

Kul til generator
Kol till generator



Mærke/ model	Type beteg.	Prod. årg.	Kul til generator Varenr. Ref.nr.	DKK	SEK
KAWASAKI					
GPX 750 R	ZX750F	87-90	099005 CBS-901	181,-	226:-
ZXR 750	ZX750H	89-90	099005 CBS-901	181,-	226:-
ZXR 750/R	ZX750J/K/L/M	91-95	099005 CBS-901	181,-	226:-
ZX 7 R/RR	ZX750P/N	96>	099005 CBS-901	181,-	226:-
GPZ 900 R		84-93	099005 CBS-901	181,-	226:-
ZL 900	ZL900A	85-86	099005 CBS-901	181,-	226:-
ZX 9 R	ZX900B	94-97	099005 CBS-901	181,-	226:-
GPX 1000 R	ZXT00A	86-87	099005 CBS-901	181,-	226:-
GTR 1000	ZGT00A	86>	099005 CBS-901	181,-	226:-
ZL 1000	ZLT00A	87>	099005 CBS-901	181,-	226:-
ZX 10	ZXT00B	88-90	099005 CBS-901	181,-	226:-
GPZ 1100 Horizont	ZXT10E/F	95-97	099005 CBS-901	181,-	226:-
ZRX 1100	ZRT10C	97-99	099005 CBS-901	181,-	226:-
ZZR 1100	ZXT10C/D	90-01	099005 CBS-901	181,-	226:-
ZRX 1200	ZRT20A	00>	099005 CBS-901	181,-	226:-
ZZR 1200	ZXT20C	02>	099005 CBS-901	181,-	226:-

SUZUKI

GSF 600 N/S Bandit	GN77B/A8	95-04	099005 CBS-901	181,-	226:-
GSX 600 F	GN72B/AJ	88-04	099005 CBS-901	181,-	226:-
RF 600 R	GN76B	93-96	099005 CBS-901	181,-	226:-
GSX 750 F	GR78A/AK	89-04	099005 CBS-901	181,-	226:-
GSX 750 Naked	AE	98>	099005 CBS-901	181,-	226:-
GSX-R 750	GR75A	85-87	099005 CBS-901	181,-	226:-
GSX-R 750	GR77B/GR7FRA	88-89	099005 CBS-901	181,-	226:-
GSX-R 750 W	GR7BB	92-95	099005 CBS-901	181,-	226:-
GSX 1100 F	GV72C	89-97	099005 CBS-901	181,-	226:-
GSX 1100 G	GV74A	91>	099005 CBS-901	181,-	226:-
GSX-R 1100	GU74C	86-88	099005 CBS-901	181,-	226:-
GSX-R 1100	GV73C	89-92	099005 CBS-901	181,-	226:-
GSX-R 1100 W	GU75C	93>	099005 CBS-901	181,-	226:-
GSF 1200 Bandit	GV75A/A9	96>	099005 CBS-901	181,-	226:-
GSX 1200 Inazuma	A3	99>	099005 CBS-901	181,-	226:-
GSX 1400	BN	01>	099005 CBS-901	181,-	226:-

099005

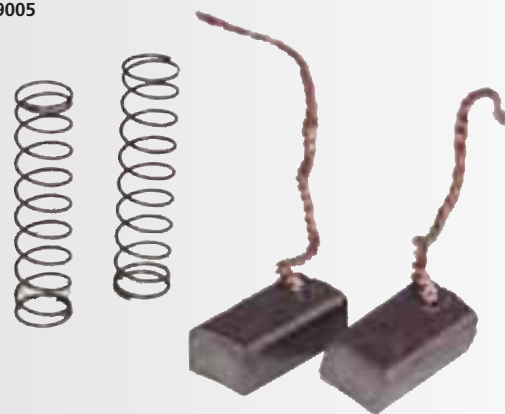

Mærke/ model	Type beteg.	Prod. årg.	Kul til generator Varenr. Ref.nr.	DKK	SEK
YAMAHA					
FZ 750	1FN/2KK/3KT	85-93	099005 CBS-901	181,-	226:-
FZR 750 R	2TT	87-88	099005 CBS-901	181,-	226:-
FZR 750 R OW01	3PG/3PH/3PJ	89-92	099005 CBS-901	181,-	226:-
FZS 750	2JE	86-89	099005 CBS-901	181,-	226:-
YZF 750 R/SP	4HN/4HT	93-98	099005 CBS-901	181,-	226:-
XJ 900 Diversion	4KM	95>	099005 CBS-901	181,-	226:-
FZR 1000 Genesis	2LA/2GH	87-88	099005 CBS-901	181,-	226:-
FZR 1000 Exup	3LE/3GM	89-95	099005 CBS-901	181,-	226:-
GTS 1000	4BH	93-98	099005 CBS-901	181,-	226:-
YZF 1000 R Thunderace	4VD/4SV	96>	099005 CBS-901	181,-	226:-
FJ 1200	1XJ/3CW/3YA	86-96	099005 CBS-901	181,-	226:-
XJR 1200/SP	4PU	95-98	099005 CBS-901	181,-	226:-
XJR 1300/SP	RP02/RP06	99>	099005 CBS-901	181,-	226:-

Starter-koblings rep.kit
Startkoppling-rep.sats

HONDA

Varenr./Art.nr.: 099020

Ref.nr.: SCK 901



Märke/mod.	Årg.	DKK	SEK
CX 500	78-79	217,-	271,-
CX 500 C	79-82	217,-	271,-
CX 500 D	79-81	217,-	271,-
CX 500 TC	82	217,-	271,-
GL 500 /I	81-82	217,-	271,-
CX 650	83	217,-	271,-
CX 650 C	83	217,-	271,-
GL 650 /I	83	217,-	271,-
CB 750 F/K	76-78	217,-	271,-
CB 750 F/K	79-82	217,-	271,-
CB 750 L	79	217,-	271,-
CB 750 C	80-82	217,-	271,-
CB 750 SC	82-83	217,-	271,-
VF 700 F	84-85	217,-	271,-
VF 700 C	84-86	217,-	271,-
VFR 700 F/F2	86-87	217,-	271,-
VF 700 S	84-85	217,-	271,-
VF 750 C	82-83	217,-	271,-
VF 750 F	83-84	217,-	271,-
VF 750 S	82-83	217,-	271,-
VF 750 C	88	217,-	271,-
VFR 750	86	217,-	271,-
CB 900 C	80-82	217,-	271,-
CB 900 F	81-82	217,-	271,-
CB 1000 C	83	217,-	271,-
GL 1000	76-79	217,-	271,-
GL 1100 L	76	217,-	271,-
GL 1100 /IL	80-83	217,-	271,-
GL 1100 A	82-83	217,-	271,-
CB 1100 F	83	217,-	271,-
VF 1100 C	83-86	217,-	271,-
VF 1100 S	84-85	217,-	271,-
GL 1200	84-87	217,-	271,-

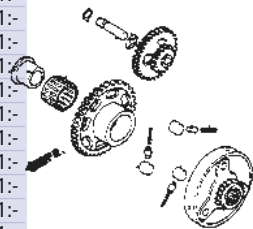

KAWASAKI

Varenr./Art.nr.: 099020

Ref.nr.: SCK 901



Märke/mod.	Årg.	DKK	SEK
KZ 440 B1/B2	80-81	217,-	271,-
KZ 440 G1	82	217,-	271,-
KZ 440 D1-D5 LTD	80-83	217,-	271,-
EN 500 A1-A6	90-96	217,-	271,-
EN 500 A1-A7	90-96	217,-	271,-
EX 500 A1-A7	87-93	217,-	271,-
EX 500 D5	94-98	217,-	271,-
KZ 650, alle	77-82	217,-	271,-
KZ 700 A1	84	217,-	271,-
ZN 700 A1-A2	84-85	217,-	271,-
KZ 750 B1-B4	76-79	217,-	271,-
KZ 750 LTD	80	217,-	271,-
KZ 750 F1 LTD	83	217,-	271,-
KZ 750 H1-H4 LTD	81-83	217,-	271,-
KZ 750 E, 4 cyl.	81-84	217,-	271,-
KZ 750 E1-E3	80-82	217,-	271,-
KZ 750 K1/K2	83-84	217,-	271,-
KZ 750 L3	83	217,-	271,-
KZ 750 N1/N2	82-83	217,-	271,-
KZ 750 R1 GP	82	217,-	271,-
KZ 750 M1 CSR	82	217,-	271,-
ZR 750 C1-C3	91-93	217,-	271,-
ZX 750 A1/A2 GPZ	83-84	217,-	271,-
ZX 750 E1/E2 Turbo	84-85	217,-	271,-
ZX 900 A1-A3	84-86	217,-	271,-
ZL 900 A1/A2 Eliminator	85-86	217,-	271,-
KZ 1300, alle	79-80	217,-	271,-
ZN 1300 A1-A6	83-88	217,-	271,-

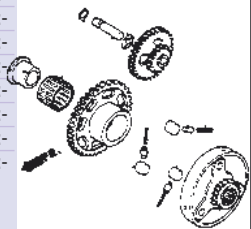

KAWASAKI

Varenr./Art.nr.: 099021

Ref.nr.: SCK 902



Märke/mod.	Årg.	DKK	SEK
KZ 900 Z1 A/B	73-75	217,-	271,-
KZ 900 A4/A5	76-77	217,-	271,-
KZ 900 B1 LTD	76	217,-	271,-
KZ 1000 B1-B3 LTD	77-79	217,-	271,-
KZ 1000 D1-D3 Z1R	78-80	217,-	271,-
KZ 1000 A1-A4	77-80	217,-	271,-
Kz 1000 C1-C4	78-81	217,-	271,-
KZ 1000 E1/E2 ST	79-80	217,-	271,-
KZ 1000 G1	80	217,-	271,-
KZ 1000 J1-J3	81-83	217,-	271,-
KZ 1000 K1/K2	81-82	217,-	271,-
KZ 1000 M1/M2 CSR	81-82	217,-	271,-
KZ 1000 R1/R2 Replica	82-83	217,-	271,-
KZ 1000 P1-P15	82-96	217,-	271,-
KZ 1100 A1-A3	81-83	217,-	271,-
KZ 1100 B1/B2 GP	81-82	217,-	271,-
KZ 1100 D1/D2 Spectre	82-83	217,-	271,-
KZ 1100 L1 LTD	83	217,-	271,-
ZN 1100 B1/B2 LTD	84-85	217,-	271,-
ZX 1100 A1/A2 GPZ	83-84	217,-	271,-

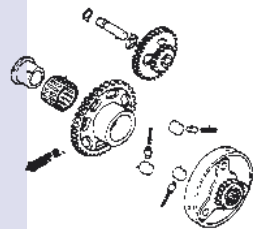

SUZUKI

Varenr./Art.nr.: 099020

Ref.nr.: SCK 901



Märke/mod.	Årg.	DKK	SEK
GSF 400 M/N/P	91-93	217,-	271,-
GS 425	79	217,-	271,-
GS 450, alle	80-83	217,-	271,-
GS 450 F/LG/LH/LJ	85-88	217,-	271,-
GS 500 E, alle	89-96	217,-	271,-
GS 500 EV/EW	97-98	217,-	271,-
GS 550 E, alle	77-82	217,-	271,-
GS 650 E, alle	81-83	217,-	271,-
GS 750, alle	77-83	217,-	271,-
GS 850, alle	79-83	217,-	271,-
GS 1000, alle	78-82	217,-	271,-
GS 1100, alle	80-83	217,-	271,-
GSX-R 1100 G/H/J	86-88	217,-	271,-

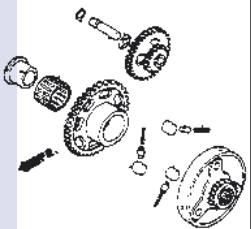

- Stikord Sökord s. 2-5
- Forhandlere Aterforsäljare s. 6-9
- Tøj/hjelme Kläder/hjälmar s. 11
- Dæk Däck s. 83
- Oljeolja s. 115
- Kæde/tandhjul Kedjor/drev s. 145
- Bremser Broms s. 187
- Låse Lås s. 347
- Batteri Batterier s. 355
- Pakninger Packningar s. 377
- Motordele Motordelar s. 411
- Lejer Lager s. 435
- Karburator Förgasare s. 467
- El-dele/Tænding Elektriskt/Tænding s. 509
- Blinklygter Baglygter Belysning Baklygter s. 611
- Lyddæmper Avgassystem s. 651
- Støddæmper Støtdåmpare s. 681
- Luft-/oliefilter Luft-/oljefilter s. 711
- Kobling Koppling s. 769
- Kabler Wire s. 803
- Styr/greb Styre/handtag s. 829
- Spejle og diverse Speglar och diverse s. 867
- Bøjer/værktøj Bøker/verktøy s. 893

Starter-koblings rep.kit
Startkoppling-rep.sats

YAMAHA

Varenr./Art.nr.: 099023
Ref.nr.: SCK 904



Mærke/mod.	Årg.	DKK	SEK
XS 400 J/K Maxim	82-83	217,-	271,-
XS 400 RJ/RK Seca	82-83	217,-	271,-
XV 535 T/TC/U/			
UC Virago	87-88	217,-	271,-
XV 535 W/WC/A/AC	89-91	217,-	271,-
XV 535 B/BC Virago	89-91	217,-	271,-
XV 535 D/DC/E/			
EC/F Virago	92-94	217,-	271,-
XV 535 FC/SF/			
SFC Virago	92-94	217,-	271,-
XV 535 G/GC/			
SG/SCG Virago	95	217,-	271,-
XJ 550 H/J/K Maxim	81-83	217,-	271,-
XJ 550 RH/RJ/RK Seca	81-83	217,-	271,-
FJ 600 L/LC/N/NC	84-85	217,-	271,-
XZ 550 RJ/RK Vision	82-83	217,-	271,-
FZ 600 SSC/T/TC/U/UC	86-88	217,-	271,-
YZF 750 RF/RFC/			
RG/RGF	94-97	217,-	271,-
YZF 750 RH/RHC/			
RJ/RJC	94-97	217,-	271,-
FZR 1000 W/WC/			
A/AC/B	89-92	217,-	271,-
FZR 1000 BC/D/DC	89-92	217,-	271,-
FZR 1000 E/EC/			
F/FC/G/GC	93-95	217,-	271,-
YZF 1000 RJ/RJC	97	217,-	271,-
VMX 12 U/UC/			
W/WC V-MAX	85-89	217,-	271,-
VMX 12 A/AC/			
B/BC/D V-MAX	90-93	217,-	271,-
VMX 12 DC/			
E/EC V-MAX	90-93	217,-	271,-
VMX 12 F/FC/			
G/GC V-MAX	94-97	217,-	271,-
VMX 12 H/HC/			
J/JC V-MAX	94-97	217,-	271,-
VMX 12 K/KC V-MAX	98	217,-	271,-
XVZ 12 TK Venture	83	217,-	271,-
XVZ 12 TDK Vent. Roy.	83	217,-	271,-
XVZ 12 L/KC2 Venture	84	217,-	271,-
XV 12 DL/DKC2 V. R.	84	217,-	271,-
XVZ 13 DN/DS/			
DSC V. Royale	85-87	217,-	271,-
XVZ 13 DT/DTC V.R.	85-87	217,-	271,-
XVZ 1300 T/TC/			
U/UC Venture	87-88	217,-	271,-
XVZ 13 DU/D/C/			
DW V. Royale	88-90	217,-	271,-
XVZ 13 DW/DA/			
DAC V. Royale	88-90	217,-	271,-
XVZ 13 DB/DBC/			
DDC V. Royale	91-93	217,-	271,-
XVZ 13 DE/DEC			
Venture Royale	91-93	217,-	271,-

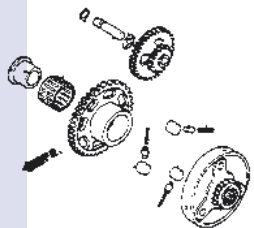

YAMAHA

Varenr./Art.nr.: 099022
Ref.nr.: SCK 903



Mærke/mod.	Årg.	DKK	SEK
XS 850 G /SG/LG	80	217,-	271,-
XS 850 H /LH/SH	81	217,-	271,-
XJ 650 LH Midnight	81>	217,-	271,-
XS 1100 E /F/G/H	78-81	217,-	271,-
XJ 650 RJ Seca	82	217,-	271,-
XS 1100 SF/SG/SH	79-81	217,-	271,-
XJ 650 J/K/L	82-83	217,-	271,-
XS 1100 LG/LH			
Midnight S.	80-81	217,-	271,-
XJ 650 Seca/Turbo	82-83	217,-	271,-
FJ 1100 SZ	84-85	217,-	271,-
XJ 750 J/K Maxim	82-83	217,-	271,-
FJ 1200 S/SC/T/TC/			
W/WC/AC	86-90	217,-	271,-
FJ 1200 B/BC/D/DC/AD	91-93	217,-	271,-
FJ 1200 ADC/AE/AEC	91-93	217,-	271,-

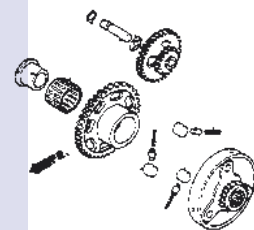

YAMAHA

Varenr./Art.nr.: 099024
Ref.nr.: SCK 905



Mærke/mod.	Årg.	DKK	SEK
XJ 650 G/H/J/K	80-83	217,-	271,-
XJ 650 LH Midnight	81	217,-	271,-
XJ 650 RJ Seca	82	217,-	271,-
XJ 650 LJ/LK			
Seca Turbo	82-83	217,-	271,-
XJ 750 J/K Maxim	82-83	217,-	271,-
XJ 750 RH/RJ/RK Seca	81-83	217,-	271,-
XJ 750 MK Midnight	83	217,-	271,-



Stator
Stator lindning



Mærke/ model	Prod. årg.	Stator Varenr.	Ref.nr.		
Mærke/ modell	Prod. årg.	Stator lindning Art.nr.	Ref.nr.	DKK	SEK
KAWASAKI					
ZX 600 F1/F3	95-99	097700	STA-401	1030,-	1288:-
ZX 600 D1/D3	ZZR 90-92	097700	STA-401	1030,-	1288:-
ZX 600 E1/E2	ZZR 93-03	097700	STA-401	1030,-	1288:-
ZX 600 E12/E13H	ZZR 04-05	097700	STA-401	1030,-	1288:-
ZX 600 E6F	ZZR 06	097700	STA-401	1030,-	1288:-
ZX 600 NIH	ZX-6RR 05	097701	STA-402	1175,-	1469:-
ZX 636 CIH	ZX-6R 05	097701	STA-402	1175,-	1469:-
ZX 600 KIH	ZX-6RR 03	097702	STA-403	1306,-	1633:-
ZX 600 M1H	ZX-6RR 04	097702	STA-403	1306,-	1633:-
ZX 600 B1H/B2H	ZX-6R 03-04	097702	STA-403	1306,-	1633:-
ZR 750 J1H/H2H	Z750 04-05	097702	STA-403	1306,-	1633:-
ZR 750 J6F	Z750 06	097702	STA-403	1306,-	1633:-
ZR 750 K1H	Z750S 05	097702	STA-403	1306,-	1633:-
ZR 750 K6F	Z750S 06	097702	STA-403	1306,-	1633:-
ZR 1000 A1H-A3H	Z1000 03-05	097702	STA-403	1306,-	1633:-
ZR 1000 A6F	Z1000 06	097702	STA-403	1306,-	1633:-
VN 800 A1-A4	95-98	097703	STA-404	1071,-	1339:-
VN 800 B1-B8	Classic 96-03	097703	STA-404	1071,-	1339:-
VN 800 B9P-B10P	Classic 04-05	097703	STA-404	1071,-	1339:-
VN 800 B6P	Classic 06	097703	STA-404	1071,-	1339:-
VN 800 C1-C2	Drifter 99-02	097703	STA-404	1071,-	1339:-
VN 1500 D1-D2	Classic 96-97	097704	STA-405	1124,-	1405:-
VN 1500 E1	Classic 98	097704	STA-405	1124,-	1405:-

SUZUKI

DR-Z 400 E K5-K7	05-07	097800	STA-301	1442,-	1803:-
DR-Z 400 S Y-K8	00-08	097800	STA-301	1442,-	1803:-
DR-Z 400 Y-K3	00-03	097800	STA-301	1442,-	1803:-
DR-Z 400 K5-K8	05-08	097800	STA-301	1442,-	1803:-
AN 600 K3-K7 Burgman	03-08	097801	STA-302	1677,-	2096:-
GSX-R600 K1	01	097802	STA-303	1289,-	1611:-
GSX-R600 K2-K3	02-03	097806	STA 307	1148,-	1435:-
GSX-R 750 Y-K1	00-01	097802	STA-303	1289,-	1611:-
GSX-R 750 K2-K3	02-03	097806	STA-307	1148,-	1435:-
GSX-R 1000 K5-K6	05-06	097803	STA-304	1455,-	1819:-
GSX-R 1000 K7-K8	07-08	097804	STA-305	1455,-	1819:-
VS 1400 GI H-S Intruder	87-95	097807	STA-308	1607,-	2009:-
VS 1400 GLP T-W Intruder	96-98	097807	STA-308	1607,-	2009:-
VL 1500 W-K3	98-03	097805	STA-306	1148,-	1435:-

YAMAHA

XV 535 Virago	89-98	097914	STA-218	1736,-	2170:-
XV 535 SE Virago	88	097914	STA-218	1736,-	2170:-
XV 535 DX Virago	88	097914	STA-218	1736,-	2170:-
XV 535 DX Virago	88	097900	STA-201	1030,-	1288:-
XV 535 SE Virago	98	097900	STA-201	1030,-	1288:-
XV 535 Virago	89-02	097900	STA-201	1030,-	1288:-
FZS Fazer / FSZ 600 S	00-01	097902	STA-204	1354,-	1693:-
FZS 600 Fazer	98-99	097902	STA-204	1354,-	1693:-
YZF 600 R Thundercat	96-04	097903	STA-205	1306,-	1633:-
YZF-R6	99-02	097904	STA-206	1306,-	1633:-
XVS 650 A Dragstar	98-02	097905	STA-207	1112,-	1390:-
XVS 650 Dragstar	97-02	097905	STA-207	1112,-	1390:-
XV 750 Virago	92->	097901	STA-202	1306,-	1633:-
XV 1000 SE	88->	097901	STA-202	1306,-	1633:-
FZS 1000 Fazer	01-05	097906	STA-209	1306,-	1633:-
YZF-R1	98-01	097907	STA-210	1354,-	1693:-
YZF-R1	02-03	097908	STA-211	1677,-	2096:-
YZF-R1 / SP	04-06	097909	STA-212	1736,-	2170:-
XV 1100 Virago	89-97	097901	STA-202	1306,-	1633:-
XVS 1100 A Dragstar	00-02	097910	STA-213	1736,-	2170:-
XVS 1100 Dragstar	99-02	097910	STA-213	1736,-	2170:-
XVS 1100 AT/AW	03-05	097912	STA-215	1736,-	2170:-
XVS 11/AW/A	04-05	097912	STA-215	1736,-	2170:-
XV 17 A/AM/ATM/AT	06-07	097913	STA-217	1736,-	2170:-

Svinghjul
Svænghjul



Mærke/ model	Prod. årg.	Svinghjul Varenr.	Ref.nr.		
Mærke/ modell	Prod. årg.	Svænghjul Art.nr.	Ref.nr.	DKK	SEK
KAWASAKI					
ZX 600 F	ZX-6R 01-03	096100	ROT-401	953,-	1191:-
ZX 600	ZZR 90-92	096100	ROT-401	953,-	1191:-
ZX 600 E	ZZR 93-06	096100	ROT-401	953,-	1191:-
ZX 600 N	ZX-6RR 05	096101	ROT-402	1795,-	2244:-
ZX 600 C	ZX-6R 05-06	096101	ROT-402	1795,-	2244:-
ZR 750 J	Z 750 04-06	096102	ROT-403	1971,-	2464:-
ZR 750 L	Z 750 07	096102	ROT-403	1971,-	2464:-
ZR 750 K	Z 750 S 05-06	096102	ROT-403	1971,-	2464:-
ZR 750 M	Z750 ABS 07-08	096102	ROT-403	1971,-	2464:-
ZR 750 C	07	096102	ROT-403	1971,-	2464:-
ZR 100 A	03-06	096102	ROT-403	1971,-	2464:-
ZR 1000 B	07	096102	ROT-403	1971,-	2464:-
Z 1000 ABS	07	096102	ROT-403	1971,-	2464:-

SUZUKI

DR-Z 400 E	05-07	096200	ROT-301	1324,-	1655:-
DR-Z 400 S	00-08	096200	ROT-301	1324,-	1655:-
DR-Z 400	00-03	096201	ROT-302	1395,-	1744:-
GSX-R600	01	096202	ROT-303	2395,-	2994:-
GSX-R 600	02-03	096203	ROT-304	2576,-	3220:-
AN 650	03-05	096204	ROT-305	3502,-	4378:-
GSX-R 750	00-01	096202	ROT-303	2395,-	2994:-
GSX-R 750	02-03	096203	ROT-304	2576,-	3220:-
GSX-R 1000	05-08	096205	ROT-306	1834,-	2293:-
VI 1500	98-03	096206	ROT-307	2576,-	3220:-

YAMAHA

XV 535	97-98	096300	ROT-201	1571,-	1964:-
YZF 600 R Thundercat	96-02	096301	ROT-202	1465,-	1831:-
FZS 1000 Fazer	01-05	096302	ROT-203	1748,-	2185:-
YZF-R1	98-01	096302	ROT-203	1748,-	2185:-
YZF-R1	02-03	096303	ROT-204	2576,-	3220:-
XVS 1100 Dragstar	00-02	096304	ROT-205	2160,-	2700:-

Generator dæksel Kawasaki
Generator lock Kawasaki
Passer til Z1/Z11/Z900/Z1000A



Ref.nr.: 18-18890
OEM nr. 21076-023
Varenr./art.nr. 174300

DKK 598,- **SEK 748,-**

Stator til Kawasaki
Stator til Kawasaki

Passer til
Z1/Z11/Z900/Z1000A



Ref.nr.: 48-98630
OEM nr. 14031-053/14031-1020
Varenr./art.nr. 174301

DKK 799,- **SEK 999,-**

- Stikord Søkdord s. 2-5
- Forhandlere Aterforsaljere s. 6-9
- Tøj/hjelme Klæder/hjælmar s. 11
- Dæk Dækk s. 83
- Olje Olja s. 115
- Kæde/tandhjul Kedjor/drev s. 145
- Bremser Broms s. 187
- Låse Lås s. 347
- Batteri Batterier s. 355
- Pakninger Packningar s. 377
- Motordele Motordelar s. 411
- Lejer Lager s. 435
- Karburator Förgasare s. 467
- El-dele/Tænding Elektriskt/Tænding s. 509
- Blinklygter Baglygter Belysning Baklygter s. 611
- Lyddæmper Avgassystem s. 651
- Støddæmper Støtdämpare s. 681
- Luft/oliefilter Luft/oljefilter s. 711
- Kobling Koppling s. 769
- Kabler Wire s. 803
- Styr/greb Styre/handtag s. 829
- Spejle og diverse Speglar och diverse s. 867
- Bøger/værktøj Bøcker/verktyg s. 893

Stator
Stator lindning

Made in EU

Mærke/ model	Prod. årg.	Stator Varenr.	Ref.nr.		
Mærke/ modell	Prod. årg.	Stator lindning Art.nr.	Ref.nr.	DKK	SEK
APRILIA					
RS 125	02-04	097405	G811	1170,-	1463:-
RS 250	02-04	097405	G811	1170,-	1463:-
Pegaso 650	94-96	097406	G96	1544,-	1930:-
ETV 1000 Caponord	02-05	097403	G814	1544,-	1930:-
RST 1000 Futura	01-04	097403	G814	1544,-	1930:-
RSV 1000 Mille	99-04	097403	G814	1544,-	1930:-
SL 1000 Falco	99-04	097403	G814	1544,-	1930:-

BMW					
F 650	94-02	097300*/097	G7/G14	1141,-	1426:-

CAGIVA					
750 Elefant	94-97	097400	G92	2734,-	3418:-
900 Elefant	93-97	097400	G92	2734,-	3418:-

DUCATI					
Tidlige Ducati'er	>85	097404	G93	2238,-	2798:-
350SS/400SS		097400	G92	2734,-	3418:-
500 Pantah	80->	097400	G92	2734,-	3418:-
600 SL Pantah		097404	G93	2238,-	2798:-
600 Monster	93-97	097400	G92	2734,-	3418:-
600 SS		097400	G92	2734,-	3418:-
M 620 Monster		097400	G92	2734,-	3418:-
620 Multistrada	05-06	097014	G52	1227,-	1534:-
620 Sport	03->	097014	G52	1227,-	1534:-
650 Indiana		097014	G52	1227,-	1534:-
650 SL Pantah	78-86	097404	G93	2238,-	2798:-
748/749/748S	95->	097400	G92	2734,-	3418:-
750 GT	74-76	097404	G93	2238,-	2798:-
750 Indiana		097022	G52	1213,-	1516:-
750 F1/Paso	86->	097400	G92	2734,-	3418:-
750 Monster	94->	097400	G92	2734,-	3418:-
750 Sport	74-76	097400	G92	2734,-	3418:-
750 Sport	01->	097022	G52	1213,-	1516:-
750 SS		097400	G92	2734,-	3418:-
750 SS	99->	097022	G52	1213,-	1516:-
800 Sport/Supersport/ Monster	03->	097014	G52	1227,-	1534:-
851 SS		097400	G92	2734,-	3418:-
860 GTS		097400	G92	2734,-	3418:-
888 Strada	89->	097400	G92	2734,-	3418:-
900 Darmah		097400	G92	2734,-	3418:-
900 Monster	94->	097400	G92	2734,-	3418:-
900 SS		097400	G92	2734,-	3418:-
900 Hailwood Replica		097404	G93	2238,-	2798:-
900 FE, S2 Replica	98	097022	G52	1213,-	1516:-
900 SS	98-02	097022	G52	1213,-	1516:-
900 Sport Desmo/SL		097014	G52	1227,-	1534:-
907 i.e. Paso	92->	097400	G92	2734,-	3418:-
916 Strada	98-99	097400	G92	2734,-	3418:-
ST 2	98	097400	G92	2734,-	3418:-
996	99->	097014	G52	1227,-	1534:-
996 ST3/ST4/ST4S	00->	097014	G52	1227,-	1534:-
998	02->	097014	G52	1227,-	1534:-
999	03-05	097014	G52	1227,-	1534:-
1000 DS/Monster/ Multistrada/SS	03->	097014	G52	1227,-	1534:-
1098, 1100 DS					
Multistr., Hypermot.		097022	G52	1213,-	1516:-
ST2	98->	097	G22		
ST3, ST4, ST4S		097022	G52	1213,-	1516:-

HONDA					
CB 250 RS (el-start)	77->	097013	G47	1761,-	2201:-
XR 350		097018	G74	1544,-	1930:-
CB1-400	89-90	097005	G17	1255,-	1569:-
CBR 400	85-87	097005	G17	1255,-	1569:-
CBR 400 RR (NC23)	88	097005*/097008*	G17/G74	1255,-	1569:-
VF 400 F	85	097008	G74	1213,-	1516:-
VFR 400 (NC24)	86	097016*/097005*	G72/G17	1141,-	1426:-
VFR 400 (NC30)	87	097016	G72	1141,-	1426:-
VFR 400 UK-model	86	097016	G72	1141,-	1426:-
VFR 400 R (NC21)	86	097016	G72	1141,-	1426:-
CX 500 A/B	79-81	097013	G47	1761,-	2201:-



* Der kan være tale om to typer ! Se venligst illustrations-tegning.

Stator
Stator lindning

Made in EU

Mærke/ model	Prod. årg.	Stator Varenr.	Ref.nr.		
Mærke/ modell	Prod. årg.	Stator lindning Art.nr.	Ref.nr.	DKK	SEK
HONDA					
CX 500 E/					
Prolink/Turbo	82-83	097000	G8	1227,-	1534:-
GL 500	82->	097000	G8	1227,-	1534:-
VF 500 F/F2	84-86	097008	G74	1213,-	1516:-
VT 500 C Shadow	83-86	097300	G7	1141,-	1426:-
VT 500 E/FT	83-84	097300	G7	1141,-	1426:-
CB 500	94-97	097019	G53	1213,-	1516:-
XL 500 R	82->	097012*/097018*	G41/G46	1544,-	1930:-
XR 500 R	83-97	097012/097018*	G41/G46	1544,-	1930:-
XBR 500		097018	G74	1544,-	1930:-
CBR 600 FJ	87-90	097008	G74	1213,-	1516:-
CBR 600 (PC25/31)	91-95	097015	G54	1213,-	1516:-
NTV 600	88->	097003	G12	1238,-	1548:-
VT 600 C Shadow	88->	097300	G7	1141,-	1426:-
XL 600	85	097012/097018*	G41/G46	1544,-	1930:-
XL 600 R	83-87	097012*/097018*	G41/G46	1544,-	1930:-
XL 600 V Transalp	87	097300	G7	1141,-	1426:-
XR 600 R	83-97	097012/097018*	G41/G46	1544,-	1930:-
XL 650 V		097300	G7	1141,-	1426:-
CB 650 SC/Z	78-85	097017	G19	1227,-	1534:-
CB 650 Z	79-82	097001	G21	1227,-	1534:-
CX 650 E/C/Turbo	83	097000	G8	1227,-	1534:-
GL 650	83	097000	G8	1227,-	1534:-
NT 650 Nighthawk	88-91	097000	G8	1227,-	1534:-
NTV 650 Deauville	94	097000	G8	1227,-	1534:-
NTV 650 Réveré	88-93	097000	G8	1227,-	1534:-
NX 650 Dominator	86-89	097300	G7	1141,-	1426:-
VT 700 C Shadow	84	097000	G8	1227,-	1534:-
VF 700 Sabre/Magna	84-87	097004	G14	1141,-	1426:-
CB 750	76-78	097001	G21	1227,-	1534:-
CB 750 C	82	097001	G21	1227,-	1534:-
CB 750 F/F2	85	097001	G21	1227,-	1534:-
CB 750 KZ (Dohc)	79-83	097001	G21	1227,-	1534:-
CB 750 FA/FB	80-82	097001	G21	1227,-	1534:-
CB 750 F2 (Dohc)	77-79	097001	G21	1227,-	1534:-
VF 750 F	83	097004	G14	1141,-	1426:-
VF 750 F Interceptor	83-85	097004	G14	1141,-	1426:-
VF 750 S V 45	82-95	097004	G14	1141,-	1426:-
Sabre/Magna	82-99	097004	G14	1141,-	1426:-
VFR 750 F G/H	88-89	097004	G14	1141,-	1426:-
VFR 750 F/J/K	90-91	097011	G75	1213,-	1516:-
VFR 750 F/L	92	097014	G52	1227,-	1534:-
NV 750 C Shadow	86	097000	G8	1227,-	1534:-
VT 750 C Shadow	83-87	097000	G8	1227,-	1534:-
VT 750 CL ACE	97->	097000	G8	1227,-	1534:-
XRV 750/Africa Twin	89-00	097300	G7	1141,-	1426:-
PC 800 Pacific Coast	89-97	097000	G8	1227,-	1534:-
VFR 800/V-tec	98-00	097014	G52	1227,-	1534:-
VFR 800	98-00	097022	G521	1213,-	1516:-
VFR 800 V-tec	00->	097020	G89	3148,-	3935:-
VT 800	88	097000	G8	1227,-	1534:-
CB 900 F/F2/C	79-83	097001	G21	1227,-	1534:-
CBR 900 RR Fireblade	92-01	097014	G52	1227,-	1534:-
CBR 900 RR Fireblade	02->	097020	G89	3148,-	3935:-
CBR 929 RR	02->	097020	G89	3148,-	3935:-
GL 1000	75	097002	G6	1227,-	1534:-
VF 1000 F/F2/R	84-85	097004	G14	1141,-	1426:-
VF 1000 Interceptor	85	097004	G14	1141,-	1426:-
VTR 1000 Firestorm	97	097014	G52	1227,-	1534:-
CBR 1000 RR	04->	097023	G111	1653,-	2066:-
VTR 1000 Firestorm	97	097004	G14	1141,-	1426:-
XLV 1000 Varadero	99	097024	G97		
CBR 1100 XX Bl.bird	96-98	097021	G522	1213,-	1516:-
CBR 1100 XX Bl.bird	99-05	097022	G52	1213,-	1516:-
GL 1100	80-83	097002	G6	1227,-	1534:-
VF 1100	83-86	097004	G14	1141,-	1426:-
VT 1100 Shadow	85-04	097000	G8	1227,-	1534:-
VT 1100 C Shadow	85-94	097000	G8	1227,-	1534:-
VT 1100 C Shadow	02->	097000	G8	1227,-	1534:-
GL 1200	84-87	097002	G6	1227,-	1534:-

* Der kan være tale om to typer ! Se venligst illustrations-tegning.

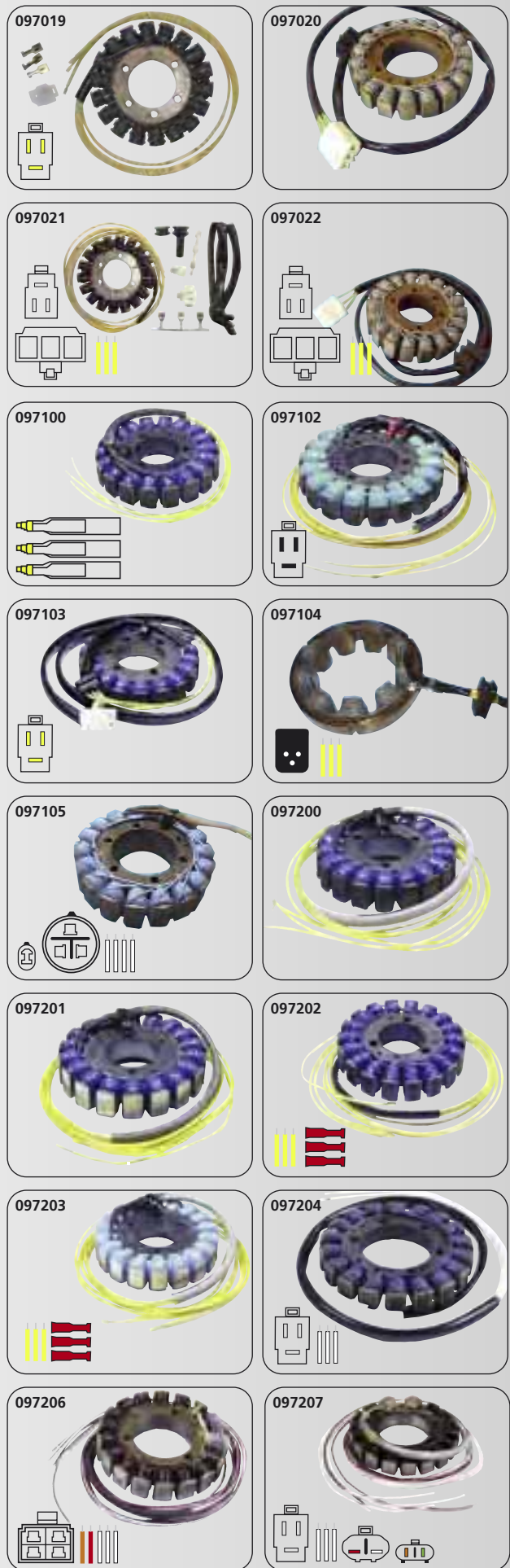

- Stikord
Søikord
s. 2-5
- Forhandlere
Aterforsäljare
s. 6-9
- Tøj/hjelme
Kläder/
hjälmnar
s. 11
- Dæk
Däck
s. 83
- Olje
Olja
s. 115
- Kæde/
tandhjul
Kedjor/
drev
s. 145
- Bremser
Broms
s. 187
- Låse
Lås
s. 347
- Batteri
Batterier
s. 355
- Pakninger
Packingar
s. 377
- Motordele
Motordelar
s. 411
- Lejer
Lager
s. 435
- Karburator
Förgasare
s. 467
- El-dele/
Tænding
Elektriskt/
Tänding
s. 509**
- Blinklygter
Baglygter
Belysning
Baklygter
s. 611
- Lyddæmper
Avgassystem
s. 651
- Støddæmper
Støtdämpare
s. 681
- Luft/
oliefilter
Luft/
oljefilter
s. 711
- Kobling
Koppling
s. 769
- Kabler
Wire
s. 803
- Styr/greb
Styre/
handtag
s. 829
- Spejle
og diverse
Speglar
och diverse
s. 867
- Bøger/
værktøj
Böcker/
verktyg
s. 893

Stator
Stator lindning

Made in EU

Mærke/ model	Prod. årg.	Stator Varenr.	Ref.nr.		
Märke/ modell	Prod. årg.	Stator lindning Art.nr.	Ref.nr.	DKK	SEK
KAWASAKI					
KLR 250	84-93	097206	G45	1544,-	1930,-
EN 400	86	097102	G11	1020,-	1275,-
Z 400/LTD.	79-83	097201*/097102*	G2/G11	814,-	1018,-
KZ 440	80-83	097102	G11	1020,-	1275,-
Z 440 Ltd.	79-83	097201*/097102*	G2/G11	814,-	1018,-
ZXR 400	89	097200	G1	932,-	1165,-
ZZR 400	90	097103	G73	1141,-	1426,-
EN 450	85-90	097102	G11	1020,-	1275,-
EN 454	85-90	097102	G11	1020,-	1275,-
EN 500	90-97	097102	G11	1020,-	1275,-
EX 500	87-97	097102	G11	1020,-	1275,-
GPZ 500 S	88-92	097102	G11	1020,-	1275,-
KLE 500		097102	G11	1020,-	1275,-
Z 500	79-83	097201	G2	814,-	1018,-
GPZ 550	82->	097201	G2	814,-	1018,-
GPZ 550 A1		097201	G2	814,-	1018,-
KZ 550	80-84	097102	G11	1020,-	1275,-
Z 550 A2		097102	G11	1020,-	1275,-
ZR 550 F Unitrack	83-84	097201	G2	814,-	1018,-
GPZ 550 Uni Track	84	097201	G2	814,-	1018,-
GPZ 550 A1		097201	G2	814,-	1018,-
Z 550/LTD.	80	097201	G2	814,-	1018,-
Z 550 Zephyr	90-96	097201	G2	814,-	1018,-
GPX 600 R	87->	097103	G73	1141,-	1426,-
GPZ 600 R	86	097013	G73	1761,-	2201,-
KL 600	84-86	097206	G45	1544,-	1930,-
KLR 600	84	097206	G45	1544,-	1930,-
ZZR 600	89-96	097103	G73	1141,-	1426,-
ZX 600	98->	097204	G9	1141,-	1426,-
ZX6R Ninja	98->	097200	G1	932,-	1165,-
ZL 600 Eliminator	95-98	097103	G73	1141,-	1426,-
KLR 650/R	84->	097206	G45	1544,-	1930,-
KLR 650 Tengai	89-92	097206	G45	1544,-	1930,-
KLX 650 R	93-96	097206	G45	1544,-	1930,-
KZ 650 E1/F1	83-84	097200	G1	932,-	1165,-
Z 650/SR/LTD.	79-84	097200	G1	932,-	1165,-
GPZ 750 Turbo	85	097202	G4	1020,-	1275,-
GPZ 750 Ninja/Turbo	85	097202	G4	1020,-	1275,-
GPZ 750 Uni Tr. A1/A3	83	097200	G1	932,-	1165,-
GT 750	86	097200*/097201*	G1/G2	932,-	1165,-
VN 750 Vulcan	86	097203	G5	1141,-	1426,-
Z 750 E/E1	80	097200	G1	932,-	1165,-
Z 750 L	84	097201*/097202*	G2/G4	814,-	1018,-
Z 750 Zephyr	91->	097200*/097201*	G1/G2	932,-	1165,-
VN 800 Classic/Vulc.	96-97	097203	G5	1141,-	1426,-
ZL 900 Eliminator	85-86	097100	G3	1020,-	1275,-
Z 900	73-76	097104	G90	1141,-	1426,-
ZX9-R	94-03	097106	G94	1544,-	1930,-
Z 1000/Z1R	77-80	097104	G90	1141,-	1426,-
Z 1000 Injection	79-80	097100	G3	1020,-	1275,-
Z 1000 J	79	097100	G3	1020,-	1275,-
Z 1000 LTD.	81	097100	G3	1020,-	1275,-
Z 1000 MK II	79-80	097200	G1	932,-	1165,-
Z 1000 R	78	097100	G3	1020,-	1275,-
Z 1000 ST	79-81	097200	G1	932,-	1165,-
ZL 1000 Eliminator	85-86	097100	G3	1020,-	1275,-
GPZ 1100	95-97	097100	G3	1020,-	1275,-
GPZ 1100 Uni Track	83-85	097100	G3	1020,-	1275,-
Z 1100 Zephyr	92	097201*/097202*	G2/G4	814,-	1018,-
ZX12-R	00-06	097105	G800	1968,-	2460,-
ZX12R		097011	G75	1213,-	1516,-
Z 1300	79-81	097200	G1	932,-	1165,-
Z 1300 DFI/Injection	84		G60	1020,-	1275,-
Z 1300 EFI	85-89	097100	G3	1020,-	1275,-
VN 1500 Classic	97	097204	G9	1141,-	1426,-
VN 1500 Vulcan	87	097204	G9	1141,-	1426,-
VN 1500 SE	88-93	097204	G9	1141,-	1426,-



* Der kan være tale om to typer! Se venligst illustrations-tegning.
* Der kan være tale om to typer ! Se venligst illustrations-tegning.

Stator
Stator lindning

Made in EU

Märke/ modell	Prod. årg.	Stator Varenr.	Ref.nr.		
------------------	---------------	-------------------	---------	--	--

Märke/ modell	Prod. årg.	Stator Art.nr.	Ref.nr.	DKK	SEK
------------------	---------------	-------------------	---------	-----	-----

KTM

250 EXC		097402	G144	1227,-	1534:-
400 EXC		097402	G144	1227,-	1534:-
525 EXC		097402	G144	1227,-	1534:-
400 SX		097402	G144	1227,-	1534:-
450 SX		097402	G144	1227,-	1534:-
525 MXC		097402	G144	1227,-	1534:-
125 EXC		097401	G146	1544,-	1930:-
200 EXC		097401	G146	1544,-	1930:-
300 EXC		097401	G146	1544,-	1930:-

MOTO GUZZI

1000 Daytona	91	097400	G92	2734,-	3418:-
1100 California/Sport		097400	G92	2734,-	3418:-
1100 California/Sport	96	097400	G92	2734,-	3418:-

SUZUKI

GN 250	86-92	097203	G5	1141,-	1426:-
GSX 250	80-81	097200	G1	932,-	1165:-
DR 350 S	90-98	097211	G285	1761,-	2201:-
GN 400	80-83	097203	G5	1141,-	1426:-
GS 400 E	89-96	097200	G1	932,-	1165:-
GSX 400 F	81-84	097200	G1	932,-	1165:-
GSX 400 T		097200	G1	932,-	1165:-
GSXR 400 (Import)		097208	G78	1544,-	1930:-
GSF 400 Bandit	91	097208	G78	1544,-	1930:-
GS 425	79	097200	G1	932,-	1165:-
GN 450		097203	G5	1141,-	1426:-
GS 450 E/L	80	097200	G1	932,-	1165:-
GS 500 E	89-97	097200	G1	932,-	1165:-
GS 500	04->	097200	G1	932,-	1165:-
GSF 500		097305	G77	1544,-	1930:-
GS 550	77-83	097200	G1	932,-	1165:-
GS 550 Katana	81-83	097200	G1	932,-	1165:-
GS 550 L (16 Valve)	83	097200	G1	932,-	1165:-
GS 550 L (8 Valve)	79-82	097200	G1	932,-	1165:-
GSX 550	83-88	097202	G4	1020,-	1275:-
VS 600 Intruder	95-96	097300	G7	1141,-	1426:-
GSX-R 600 K1		097209	G95	1544,-	1930:-
DR 650 R/RE/RS/S	90-95	097207	G43	1544,-	1930:-
GS 650 GL/GT	81-86	097200	G1	932,-	1165:-
GS 650 Katana	81-86	097200	G1	932,-	1165:-
LS 650	86-98	097301	G9	1141,-	1426:-
LS 650 Savage	95-98	097301	G9	1141,-	1426:-
SV 650/S	98-08	097203	G5	1141,-	1426:-
XF 650 Freewind	97	097207	G43	1544,-	1930:-
VS 700 Intruder	86-91	097300	G7	1141,-	1426:-
GSX 750 E/ES	83-85	097201	G2	814,-	1018:-
GSX 750 E/L	81-82	097200	G1	932,-	1165:-
GSX 750 EF	84-85	097201	G2	814,-	1018:-
GSX 750 ET		097200	G1	932,-	1165:-
GSX-R 750 K1		097209	G95	1544,-	1930:-
VS 750 Intruder	86-91	097300	G7	1141,-	1426:-
VS 800 Intruder	90-96	097300	G7	1141,-	1426:-
VX 800	90-96	097008	G74	1213,-	1516:-
DR 800 S	90-96	097207	G43	1544,-	1930:-
GS 850/G	79-88	097200	G1	932,-	1165:-
GS 1000	78-84	097201	G2	814,-	1018:-
GS 1000 Katana	82-84	097200	G1	932,-	1165:-
GSX 1000 E	82-84	097201	G2	814,-	1018:-
GS 1100 G (16 Valve)	84-89	097201	G2	814,-	1018:-
GSX 1100 E/EF/ES	86	097201	G2	814,-	1018:-
GSX 1100 Katana	93	097200	G1	932,-	1165:-
GSX 1300 Hayabusa		097210	G213	1968,-	2460:-
GSX 1400		097204	G9	1141,-	1426:-
VS 1400 Intruder	87-97	097301	G9	1141,-	1426:-

TRIUMPH

Tiger	96	097011	G75	1213,-	1516:-
Bonneville		097300	G7	1141,-	1426:-
Speed 4		097107	G660	1761,-	2201:-
600/650 Daytona		097107	G660	1761,-	2201:-
TT 600		097107	G660	1761,-	2201:-
675		097408	G690	1761,-	2201:-
Speedtriple 1050	06	097011	G75	1213,-	1516:-

Märke/ modell	Prod. årg.	Stator Varenr.	Ref.nr.		
------------------	---------------	-------------------	---------	--	--

Märke/ modell	Prod. årg.	Stator Art.nr.	Ref.nr.	DKK	SEK
------------------	---------------	-------------------	---------	-----	-----

YAMAHA

RD 250 YPVS	84	097304	G86	1227,-	1534:-
XV 250 Virago	88->	097103	G73	1141,-	1426:-
RD 350 LCF/N/F	88-90	097304	G86	1227,-	1534:-
RD 350 YPVS	83-85	097304	G86	1227,-	1534:-
RD 350 YPVS	83-85	097308	ST4384	1968,-	2460:-
XV 535	88-96	097204	G9	1141,-	1426:-
XZ 550	82-84	097300	G7	1141,-	1426:-
FZR 600	89-99	097306	G76	1213,-	1516:-
FZF 600/FZS600		097008	G74	1213,-	1516:-
XJ 600	80-91	097306	G76	1213,-	1516:-
XJ 600 Diversion	92->	097306	G76	1213,-	1516:-
XT 600 (el-start)	84-90	097206	G45	1544,-	1930:-
XT 600 (el-start)	95->	097103	G73	1141,-	1426:-
XT 600 (el-start)	01-03	097103	G73	1141,-	1426:-
XS 650		097007	G62	1438,-	1798:-
XS 650 TC1	81	097007	G62	1438,-	1798:-
XS 650 SE	80	097007	G62	1438,-	1798:-
SRX 600	86-92	097206	G45	1544,-	1930:-
YZF R6	94-99	097008	G74	1213,-	1516:-
YZF R6	00->	097305	G77	1544,-	1930:-
FZS 600	98-03	097008	G74	1213,-	1516:-
XJ 650	80-83	097302	G32	1227,-	1534:-
XJ 650 (udv. stator)		097007	G62	1438,-	1798:-
SZR 660	96	097300*/097008*	G7/G74	1141,-	1426:-
XTZ 660	89-96	097204*/097103*	G9/G73	1141,-	1426:-
XJ 700 Maxim	80->	097302	G32	1227,-	1534:-
XJ 750/J	80-83	097302	G32	1227,-	1534:-
XV 750	81-85	097300	G7	1141,-	1426:-
XV 750 Virago	86-96	097300	G7	1141,-	1426:-
XTZ 750	89-96	097103	G9/G73	1141,-	1426:-
TDM 850	92-01	097300	G7	1141,-	1426:-
TRX 850	95	097301	G9	1141,-	1426:-
XJ 900	83-94	097302	G32	1227,-	1534:-
XV 920	81-85	097307	G13	1544,-	1930:-
XV 1000 (TR1)	81-85	097307	G13	1544,-	1930:-
XV 1000 Virago	86-97	097300	G7	1141,-	1426:-
XV 1100 Virago	87-97	097300	G7	1141,-	1426:-
V-MAX 1200	85-95	097000	G8	1227,-	1534:-
XVZ 1200	84-87	097000	G8	1227,-	1534:-
XVZ 1300	89-91	097000	G8	1227,-	1534:-
XVZ 1300 Royal Star	96-97	097000	G8	1227,-	1534:-
FJR 1300	03-05	097300	G7	1141,-	1426:-
XV 1600 Roadstar	98->	097309	G175	1761,-	2201:-

Stikord
Sökord
s. 2-5

Forhandlere
Återförsäljare
s. 6-9

Töj/hjelm
Kläder/
hjälm
s. 11

Däck
Däck
s. 83

Olje
Olja
s. 115

Käde/
tandhjul
Kedjor/
drev
s. 145

Bremser
Broms
s. 187

Låse
Lås
s. 347

Batteri
Batterier
s. 355

Pakningar
Packningar
s. 377

Motordele
Motordelar
s. 411

Lejer
Lager
s. 435

Karburator
Förgasare
s. 467

El-dele/
Tänding
Elektriskt/
Tänding
s. 509

Blinklygter
Baglygter
Belysning
Baklygter
s. 611

Lyddämp
Avgassystem
s. 651

Stöddämp
Stötdämpare
s. 681

Luft/
oljefilter
Luft/
oljefilter
s. 711

Kobling
Koppling
s. 769

Kabler
Wire
s. 803

Styr/gre
Styre/
handtag
s. 829

Spejle
Speglar
och diverse
s. 867

Böjer/
værkto
Böcker/
værktyg
s. 893

 Tændingslåse
 Tändningslås



Mærke/ model	Prod. årg.	Varenr.	Ref.nr.		
Mærke/ modell	Prod. årg.	Art.nr.	Ref.nr.	DKK	SEK
HONDA					
CB 250 K	68-75	171000	40-37600	295,-	369,-
CB 250 N/ND Euro	79-82	171003	40-71130	295,-	369,-
CB 250 T	77-78	171003	40-71130	295,-	369,-
XL 250 R	82-88	171014	40-71214	185,-	231,-
XL 250 S	79-81	171015	40-71110	75,-	94,-
CB 250/400 N/T/CM.		171003	40-71130	295,-	369,-
CB 350 F	73-74	171000	40-37600	295,-	369,-
CB 360 G	75	171000	40-37600	295,-	369,-
CB 400 F		171001	40-15820	295,-	369,-
VF 400 F		171002	40-15840	338,-	423,-
CB 400 Four	77-79	171001	40-15820	295,-	369,-
CB 400 N Eurosport	79-84	171003	40-71130	295,-	369,-
CB 400 T	77-78	171003	40-71130	295,-	369,-
CM 400 T	80-84	171003	40-71130	295,-	369,-
CB 450 K	68-75	171000	40-37600	295,-	369,-
CB 450 N	85-88	171003	40-71130	295,-	369,-
CB 500 F		171000	40-37600	295,-	369,-
CB 500 K3		171001	40-15820	295,-	369,-
CB 500 F		171002	40-15840	338,-	423,-
CX 500	Alle	171012	40-15860	319,-	399,-
CB 500 Four	71-77	171000	40-37600	295,-	369,-
CX 500	77-83	171010	40-15830	295,-	369,-
CX 500 C Custom	80-84	171010	40-15830	295,-	369,-
VF 500 F/II	84-86	171002	40-15840	338,-	423,-
XL 500 R	82-84	171014	40-71214	185,-	231,-
CB 550 F1/F2 Supersport	75-78	171000	40-37600	295,-	369,-
CB 550 FOUR	77-78	171001	40-15820	295,-	369,-
CB 550 F/K		171001	40-15820	295,-	369,-
CBR 600 F	87-90	171002	40-15840	338,-	423,-
CBR 600 F2/F3	91-98	171011	40-15870	319,-	399,-
CBR 600 F	87-90	171002	40-15840	338,-	423,-
CBR 600 F	91-96	171011	40-15870	319,-	399,-
CB 650 /C	78-82	171001	40-15820	295,-	369,-
CB 650	79-83	171001	40-15820	295,-	369,-
CB 750 C	81-83	171001	40-15820	295,-	369,-
CB 750 Four K0-6	69-76	171000	40-37600	295,-	369,-
CB 750 Four K7	77-78	171001	40-15820	295,-	369,-
CB 750 F1 Sport	75-76	171000	40-37600	295,-	369,-
CB 750 K1-K6.		171000	40-37600	295,-	369,-
CB 750 F1/F2/K6/K7		171001	40-15820	295,-	369,-
CB 750 KZ		171001	40-15820	295,-	369,-
CB 750 F/FA/FB/FC		171001	40-15820	295,-	369,-
VF 750 S/C/F		171002	40-15840	338,-	423,-
VFR 750 FG/FH/FJ/FK		171002	40-15840	338,-	423,-
CB 750 F2 Super-Sport	77-78	171001	40-15820	295,-	369,-
CB 750 F/II Bol d'Or	79-84	171001	40-15820	295,-	369,-
CB 750 K	79-82	171001	40-15820	295,-	369,-
VF 750 C Magna	82-92	171002	40-15840	338,-	423,-
VF 750 F Interceptor	83-86	171002	40-15840	338,-	423,-
CB 900 F/FZ/C		171001	40-15820	295,-	369,-
CB 900 F/II Bol D'Or	79-84	171001	40-15820	295,-	369,-
CBR 900 RR	94-97	171013	40-15880	335,-	419,-
CBR 900	93-97	171013	40-15880	335,-	419,-
CBR 1000	87-97	171002	40-15840	338,-	423,-
CBX 1000	79-81	171001	40-15820	295,-	369,-
CBX 1000 Pro Link	81-82	171010	40-15830	295,-	369,-
GL 1000	78-79	171010	40-15830	295,-	369,-
VF 1000 F		171002	40-15840	338,-	423,-
GL 1100	80-81	171010	40-15830	295,-	369,-
CBR 1000 F	87-88	171002	40-15840	338,-	423,-
CBX 1000	78-80	171001	40-15820	295,-	369,-

171000 HONDA

OEM nr.:
35100-341-700
35100-324-672
35100-323-672



171001 HONDA

OEM nr.:
35100-422-017
35100-438-007



171002 HONDA

OEM nr.:
OEM nr. 35100-MN4-672



171003 HONDA

OEM nr.:
35100-413-007
35100-465-007
35100-465-770



Tændingslåse
Tændningslås



Mærke/ model	Prod. årg.	Varenr.	Ref.nr.		
Märke/ modell	Prod. årg.	Art.nr.	Ref.nr.	DKK	SEK

HONDA					
CBX 1000 Pro Link	81-82	171010	40-15830	295,-	369,-
GL 1000 Gold-Wing	76-77	171001	40-15820	295,-	369,-
GL 1000 Gold-Wing	78-79	171010	40-15830	295,-	369,-
VF 1000 F/ FI/ Interceptor	84-86	171002	40-15840	338,-	423,-
GL 1100 Gold-Wing	80-83	171010	40-15830	295,-	369,-

KAWASAKI					
Z 200	77-83	171105	40-80642	125,-	156,-
KLR 250	84-93	171106	40-80630	168,-	210,-
Z 250 C/ LTD (1 cyl.)	79-82	171105	40-80642	125,-	156,-
Z 250 (2 cyl.)	79-82	171105	40-80642	125,-	156,-
Z 400 (2 cyl.)	74-80	171105	40-80642	125,-	156,-
Z 400 C (2 cyl.)	79	171105	40-80642	125,-	156,-
Z 400 J		171101	40-80640	338,-	423,-
GPZ 500 S	87-96	171101	40-80640	338,-	423,-
GPZ 550/ Z 550 GP	82-83	171101	40-80640	338,-	423,-
GPZ 550 Unitrak	84-89	171101	40-80640	338,-	423,-
GT 550/ Z 550 GT	83-94	171101	40-80640	338,-	423,-
KZ 550	82-86	171101	40-80640	338,-	423,-
Z 550 F Unitrak	83-84	171101	40-80640	338,-	423,-
Z 550 LTD	82-83	171101	40-80640	338,-	423,-
ZR 550	82-83	171101	40-80640	338,-	423,-
ZR 550/750 Zephyr		171101	40-80640	338,-	423,-
ZX 550	84-86	171101	40-80640	338,-	423,-
GPZ 600 R		171101	40-80640	338,-	423,-
GPZ 600 R	85-90	171107	40-80610	98,-	123,-
GPX 600		171101	40-80640	338,-	423,-
GPX 600 R	88>	171107	40-80610	98,-	123,-
ZZR 600	90-92	171103	40-80626	373,-	466,-
ZZR 600	93-04	171102	40-80622	338,-	423,-
ZX 600	85-86	171101	40-80640	338,-	423,-
ZX-6R	93-00	171104	40-80624	396,-	495,-
ZX 600 E1-E5	93-01	171102	40-80622	338,-	423,-
Z 650 B	77-79	171100	40-80600	295,-	369,-
Z 650 F/LTD	80	171100	40-80600	295,-	369,-
Z 650 F	81-83	171101	40-80640	338,-	423,-
Z 650 CSR	81-83	171101	40-80640	338,-	423,-
Z 650 LTD	81-83	171101	40-80640	338,-	423,-
Z 650 SR	79-80	171100	40-80600	295,-	369,-
Z 650/750/900/1000	73-80	171100	40-80600	295,-	369,-
ZX 7R M1-M2		171102	40-80622	338,-	423,-
ZX 7 R M1-M2	96-99	171102	40-80622	338,-	423,-
GPX 750		171101	40-80640	338,-	423,-
GPX 750 R	87-90	171107	40-80610	98,-	123,-
GPZ 750	82	171101	40-80640	338,-	423,-
GPZ 750 Unitrak	83-89	171101	40-80640	338,-	423,-
GPZ 750 R	84-91	171107	40-80610	98,-	123,-
GPZ 750 Turbo	84-85	171101	40-80640	338,-	423,-
KZ 750 2 cyl	76-80	171100	40-80600	295,-	369,-
KZ 750	80-88	171101	40-80640	338,-	423,-
VN 750 Vulcan	86-93	171107	40-80610	98,-	123,-
Z 750 B (2 cyl.)	76-78	171100	40-80600	295,-	369,-
Z 750 E	80-82	171101	40-80640	338,-	423,-
Z 750 GP (R1)	82	171101	40-80640	338,-	423,-
Z 750 GT Kardan	82-85	171101	40-80640	338,-	423,-
Z 750 (L3/L4)	83-84	171101	40-80640	338,-	423,-
Z 750 LTD (4 cyl.)	80-82	171101	40-80640	338,-	423,-
ZX 750	83-89	171101	40-80640	338,-	423,-
ZX 750 L1-L2		171102	40-80622	338,-	423,-
ZX 750 M1-M2		171102	40-80622	338,-	423,-
ZXR 750		171102	40-80622	338,-	423,-
ZXR 750	93-95	171102	40-80622	338,-	423,-
ZXR 750 R	93-95	171102	40-80622	338,-	423,-
GPZ 900 R	84-88	171101	40-80640	338,-	423,-
GPZ 900 R	84-90		40-80610		
GPZ 900 R	91-94	171103	40-80626	373,-	466,-
Z 900/ Z1/ Z1A/ Z1B	73-76	171100	40-80600	295,-	369,-
ZX 9 R Ninja	94-97	171104	40-80624	396,-	495,-
GPZ 1000 RX	85-88	171101	40-80640	338,-	423,-
GTR 1000	86-96	171101	40-80640	338,-	423,-
Z 1000 J/R		171101	40-80640	338,-	423,-
Z 1000 ST		171101	40-80640	338,-	423,-
Z 1000 A1/A2	77-78	171100	40-80600	295,-	369,-

171010 HONDA

OEM nr.:
35100-431-037



171011 HONDA

OEM nr.:
OEM nr. 35010-MV9-601
OEM nr. 35010-MV9-630
OEM nr. 35010-MAL-600



171012 HONDA

OEM nr.:
35100-415-007/017



171013 HONDA

OEM nr.:
35100-MAE-601

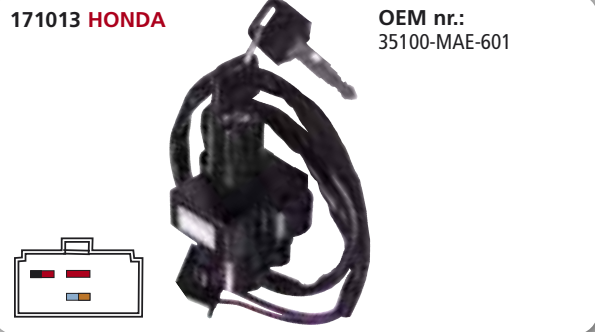

171100 KAWA

OEM nr.:
27005-083/5007



- Stikord Sökord s. 2-5
- Forhandlere Aterforsäljare s. 6-9
- Tøj/hjelme Kläder/hjälmor s. 11
- Dæk Däck s. 83
- Olie Olja s. 115
- Kæde/ tandhjul Kedjor/drev s. 145
- Bremser Broms s. 187
- Låse Lås s. 347
- Batteri Batterier s. 355
- Pakninger Packningar s. 377
- Motordele Motordelar s. 411
- Lejer Lager s. 435
- Karburator Förgasare s. 467
- El-dele/ Tænding Elektriskt/ Tänding s. 509
- Blinklygter Baglygter Belysning Baklygter s. 611
- Lyddæmper Avgassystem s. 651
- Støddæmper Støtdåmpare s. 681
- Luft-/ oliefilter Luft-/ oljefilter s. 711
- Kobling Koppling s. 769
- Kabler Wire s. 803
- Styr/greb Styre/handtag s. 829
- Spejle og diverse Speglar och diverse s. 867
- Bøger/ værktøj Böcker/ verktyg s. 893

Tændingslåse
Tändningslås



Mærke/ model	Prod. årg.	Varenr.	Ref.nr.		
Märke/ modell	Prod. årg.	Art.nr.	Ref.nr.	DKK	SEK
KAWASAKI					
Z 1000 MKII	79-80	171100	40-80600	295,-	369,-
Z 1000 H1 (Einspritzer)	80	171100	40-80600	295,-	369,-
Z 1000 J	81-82	171101	40-80640	338,-	423,-
Z 1000 LTD	77-80	171100	40-80600	295,-	369,-
Z 1000 LTD	81-83	171101	40-80640	338,-	423,-
Z 1000 Police	82-96	171101	40-80640	338,-	423,-
Z 1000 R1/R2	82-83	171101	40-80640	338,-	423,-
Z 1000 ST	79-80	171100	40-80600	295,-	369,-
Z 1000 Z1R	78-80	171100	40-80600	295,-	369,-
ZX 10	88-91	171101	40-80640	338,-	423,-
GPZ 1100 Pre-Unitrak	81-82	171101	40-80640	338,-	423,-
GPZ 1100 Unitrak	83-85	171101	40-80640	338,-	423,-
GPZ 1100	95-97	171101	40-80640	338,-	423,-
GPZ 1100 Uni Trak		171101	40-80640	338,-	423,-
KZ 1100		171101	40-80640	338,-	423,-
Z 1100 GP	81-82	171101	40-80640	338,-	423,-
Z 1100 ST	81-83	171101	40-80640	338,-	423,-
ZZR 1100	90-96	171101	40-80640	338,-	423,-
L1-L3/M1-M2	93-96	171102	40-80622	338,-	423,-
SUZUKI					
AN 125	95-99	171209	40-69999	278,-	348,-
GT 200	79-81	171210	40-71066	98,-	123,-
GN 250	87-95	171200	40-71010	295,-	369,-
GT 250	73-78	171210	40-71066	98,-	123,-
GT 250 E	79-83	171210	40-71066	98,-	123,-
GSX 250/400		171200	40-71010	295,-	369,-
SP 370	78-80	171210	40-71066	98,-	123,-
GS 400 /E	77-83	171200	40-71010	295,-	369,-
GSF 400 Bandit	91-95	171202	40-71030	338,-	423,-
GSX R 400		171202	40-71030	338,-	423,-
GSX 400 E/ L/ S	80-81	171200	40-71010	295,-	369,-
GSX 400 E/ S	82-87	171200	40-71010	295,-	369,-
GSX 400 FE Katana	81-83	171200	40-71010	295,-	369,-
GS 450 E/L/S/T	80-83	171200	40-71010	295,-	369,-
GS 450 L	85-87	171200	40-71010	295,-	369,-
GS 450 S/ SU/ E/ EU	85-89	171200	40-71010	295,-	369,-
GS 500 E (2 Zyl.)	89-99	171202	40-71030	338,-	423,-
GS 500 E (2 Zyl.)	fra 00	171202	40-71030	338,-	423,-
GS 500 F	fra 04	171202	40-71030	338,-	423,-
GT 500	71-75	171210	40-71066	98,-	123,-
GS 500 E	89>	171208	40-71032	335,-	419,-
GS 500 E	97-98	171202	40-71030	338,-	423,-
GS 550 /D/E/L/T/M	77-82	171200	40-71010	295,-	369,-
GS 550 M Katana	81-83	171200	40-71010	295,-	369,-
GSX 550/650/1100		171200	40-71010	295,-	369,-
GSF 600 Bandit	96-99	171207	40-71082	378,-	473,-
GSF 600 Bandit		171202	40-71030	338,-	423,-
GSF 600 N/S Bandit	95-99	171207	40-71082	378,-	473,-
GSX 600 F	88-97	171202	40-71030	338,-	423,-
GSX 600 F	88-97	171202	40-71030	338,-	423,-
RF 600	93-97	171202	40-71030	338,-	423,-
RF 600 R	93-96	171202	40-71030	338,-	423,-
GS 650 G Katana	81-83	171200	40-71010	295,-	369,-
GS 750 D/E/L	77-79	171200	40-71010	295,-	369,-
GSX 750 E/L	80-82	171200	40-71010	295,-	369,-
GSX 750 ESD/ES/ESF		171200	40-71010	295,-	369,-
GSX 750 F	89-97	171202	40-71030	338,-	423,-
GSX 750 S Katana	82-83	171200	40-71010	295,-	369,-
GSX 750 F	89-97	171202	40-71030	338,-	423,-
GSX R 750	93-98	171207	40-71082	378,-	473,-
GSX-R 750	88-89	171202	40-71030	338,-	423,-
GSX-R 750	90-91	171202	40-71030	338,-	423,-
GSX-R 750 W	92-95	171207	40-71082	378,-	473,-
GSX R 750					
Alle karburatormodeller					
Alle förgasaremodeller	Alle	171202	40-71030	338,-	423,-
VX 800	90-96	171202	40-71030	338,-	423,-
GS 850 G/ GL	79-81	171200	40-71010	295,-	369,-
GS 850 G/ GL	82-86	171200	40-71010	295,-	369,-
RF 900 R/ RS2	94-97	171202	40-71030	338,-	423,-
RF 900	94-97	171202	40-71030	338,-	423,-
GS 1000/1100		171200	40-71010	295,-	369,-

171101 KAWA **OEM nr.**
27005-5009/5024/
5036/5061/5019

171102 KAWA **OEM nr.**
27005-1169/1179

171103 KAWA **OEM nr.**
27005-5051

171104 KAWA **OEM nr.**
27005-1180

171200 SUZUKI **OEM nr.**
37100-47010/11
37100-49012
37100-40011
37100-43451
37100-47001

Tændingslåse
Tændningslås



Mærke/ modell	Prod. årg.	Varenr.	Ref.nr.		
Märke/ modell	Prod. årg.	Art.nr.	Ref.nr.	DKK	SEK
SUZUKI					
GS 1000 E/H/L/S	78-80	171200	40-71010	295,-	369,-
GS 1000 G/ GL Kardan	80-81	171200	40-71010	295,-	369,-
GS 1100 G Kardan	84-86	171200	40-71010	295,-	369,-
GSX 1100					
FJ/FK/FL/FM/FN/FR/FS		171202	40-71030	338,-	423,-
GSX R modeller ALLE		171202	40-71030	338,-	423,-
GSX R 1100	89-94	171200	40-71010	295,-	369,-
GSX R 1100	95-98	171207	40-71082	378,-	473,-
GSX 1100 E/L	80-81	171200	40-71010	295,-	369,-
GSX 1100 E	82-83	171200	40-71010	295,-	369,-
GSX 1100 F	89-97	171202	40-71030	338,-	423,-
GSX 1100 G	fra 91	171202	40-71030	338,-	423,-
GSX-R 1100	86-88	171202	40-71030	338,-	423,-
GSX-R 1100	89-92	171202	40-71030	338,-	423,-
GSX-R 1100 W	fra 93	171207	40-71082	378,-	473,-
GSX 1100 SZ Katana	80-85	171200	40-71010	295,-	369,-
GSF 1200 Bandit		171202	40-71030	338,-	423,-
GSF 1200 Bandit	96-00	171207	40-71082	378,-	473,-
TS-modeller ALLE	79-87	171201	40-71000	185,-	231,-

YAMAHA					
DT 125 LC	82-85	171317	40-71460	98,-	123,-
DT 125 R	Fra 91	171310	40-71492	220,-	275,-
RD 125 LC		171301	40-71410	310,-	388,-
TZR 125	97-99	171318	40-71436	98,-	123,-
DT 175 MX	78-81	171319	40-71450	98,-	123,-
RD 250 LC	80-82	171320	40-71310	150,-	188,-
SR 250 SE	80-82	171307	40-71340	240,-	300,-
SR 250 SE	80-82	171300	40-71360	240,-	300,-
TZR 250	87-92	171310	40-71492	220,-	275,-
XS 250 C		171300	40-71360	240,-	300,-
XT 250	80-90	171320	40-71310	150,-	188,-
XT 250/500/550-600		171301	40-71410	310,-	388,-
XV 250 Virago	88-00	171321	40-71370	210,-	263,-
RD 350 LC YPVS	83-84	171315	40-71382	295,-	369,-
RD 350 LC	80-82	171320	40-71310	150,-	188,-
XT 350	85-86	171318	40-71436	98,-	123,-
XT 350	87-90	171323	40-71494	175,-	219,-
XS 400 SE Special	81-82	171307	40-71340	240,-	300,-
XS 400 SE Special	81-82	171300	40-71360	240,-	300,-
XS 400 DOHC	82-87	171307	40-71340	240,-	300,-
XS 400 DOHC	82-87	171300	40-71360	240,-	300,-
XS 400 DOHC		171300	40-71360	240,-	300,-
XT 500	76-89	171319	40-71450	98,-	123,-
XV 500	83-87	171307	40-71340	240,-	300,-
XV 500	83-87	171300	40-71360	240,-	300,-
XV 535 S/SE Virago		171324	40-71372	275,-	344,-
XV 535 S/SE Virago	88-03	171325	40-71376	210,-	263,-
XV 535 /SE/S/DX	88-00	171311	40-71376	295,-	369,-
XJ 550	81-83	171307	40-71340	240,-	300,-
XJ 550	81-83	171300	40-71360	240,-	300,-
XJ 550		171300	40-71360	240,-	300,-
XJ 550 R		171307	40-71340	240,-	300,-
XT 550	82-83	171326	40-71410	175,-	219,-
FJ 600		171307	40-71340	240,-	300,-
FZ 600		171307	40-71340	240,-	300,-
FZ 600		171300	40-71360	240,-	300,-
FZR 600	89-99	171307	40-71340	240,-	300,-
FZR 600	89-93	171309	40-71320	233,-	291,-
XJ 600		171300	40-71360	240,-	300,-
XJ 600	92-96	171307	40-71340	240,-	300,-
XJ 600	90	171308	40-71464	338,-	423,-
XJ 600 N/S Diversion	92-97	171308	40-71464	338,-	423,-
XJ/FJ 600	84-88	171307	40-71340	240,-	300,-
XJ 600	85-88	171300	40-71360	240,-	300,-
XJ 600	89-91	171327	40-71464	250,-	313,-
XT 600	84-89	171326	40-71410	175,-	219,-
XT 600 K	91-95	171310	40-71492	240,-	300,-
XT 600 Z Tenere	83-87	171326	40-71410	175,-	219,-
XT 600	87	171310	40-71492	240,-	300,-
XJ 650	80-83	171307	40-71340	240,-	300,-
XJ 650	80-83	171300	40-71360	240,-	300,-
XS 650 US-Custom	80	171307	40-71340	240,-	300,-

171201 SUZUKI **OEM nr.**
37110-25318

171202 SUZUKI **OEM nr.**
37100-47011
37100-17C02
37100-17C00
37100-01D02
37100-06800
37100-26D02
37100-33E00
37100-33D00

Ref.nr.
40-71030 / 41-71032

171207 SUZUKI **OEM nr.**
40-71082

171208 SUZUKI **OEM nr.**
37100-26D02

171300 YAMAHA
4 polet stik **OEM nr.**
41Y-82501-81
3Y6-82501-81
2K1-82508-80

- Stikord Sökord s. 2-5
- Forhandlere Aterforsäljare s. 6-9
- Tøj/hjelme Kläder/hjälmor s. 11
- Dæk Däck s. 83
- Olie Olja s. 115
- Kæde/tandhjul Kedjor/drev s. 145
- Bremser Broms s. 187
- Låse Lås s. 347
- Batteri Batterier s. 355
- Pakninger Packningar s. 377
- Motordele Motordelar s. 411
- Lejer Lager s. 435
- Karburator Förgasare s. 467
- El-dele/ Tænding Elektriskt/ Tänding s. 509
- Blinklygter Baglygter Belysning Baklykter s. 611
- Lyddæmper Avgassystem s. 651
- Støddæmper Støtdåmpere s. 681
- Luft-/oliefilter Luft-/oljefilter s. 711
- Kobling Koppling s. 769
- Kabler Wire s. 803
- Styr/greb Styre/handtag s. 829
- Spejle og diverse Speglar och diverse s. 867
- Bøger/værktøj Böcker/verktyg s. 893

Tændingslåse
Tändningslås



Mærke/ model	Prod. årg.	Varenr.	Ref.nr.		
Märke/ modell	Prod. årg.	Art.nr.	Ref.nr.	DKK	SEK
YAMAHA					
XS 650 SE	81-83	171300	40-71360	240,-	300,-
XJ 650		171307	40-71340	240,-	300,-
XJ 650		171300	40-71360	240,-	300,-
XS 650		171307	40-71340	240,-	300,-
XS 650 SE		171300	40-71360	240,-	300,-
FZ 750	85-88	171300	40-71360	240,-	300,-
FZ 750	85-88	171307	40-71340	240,-	300,-
FZ 750	89-94	171308	40-71464	338,-	423,-
FZR 750		171307	40-71340	240,-	300,-
FZR 750 R	87-88	171307	40-71340	240,-	300,-
FZR 750 R	87-88	171300	40-71360	240,-	300,-
XJ 750 Seca	82-84	171307	40-71340	240,-	300,-
XJ 750 Seca	82-84	171300	40-71360	240,-	300,-
XJ 750		171300	40-71360	240,-	300,-
XJ 750 M		171307	40-71340	240,-	300,-
XS 750 U.S. Custom	80-82	171307	40-71340	240,-	300,-
XS 750 SE	80-82	171300	40-71360	240,-	300,-
XS 750 S		171307	40-71340	240,-	300,-
XV 750	92-96	171312	40-71380	295,-	369,-
XV 750 M		171307	40-71340	240,-	300,-
XV 750 SE		171300	40-71360	240,-	300,-
XV 750 SE Special	81-83	171307	40-71340	240,-	300,-
XV 750 SE Special	81-83	171300	40-71360	240,-	300,-
XV 750 Virago	92-97	171312	40-71380	295,-	369,-
TDM 850	91-96	171308	40-71464	338,-	423,-
XS 850 L/S		171307	40-71340	240,-	300,-
XS 850	80-81	171307	40-71340	240,-	300,-
XS 850	80-81	171300	40-71360	240,-	300,-
XJ 900	83-94	171307	40-71340	240,-	300,-
XJ 900	83-94	171300	40-71360	240,-	300,-
XJ 900 Diversion		171308	40-71464	338,-	423,-
XV 920		171307	40-71340	240,-	300,-
XV 920 SE Special	81-83	171307	40-71340	240,-	300,-
FZR 1000		171307	40-71340	240,-	300,-
FZR 1000 Exup	89-93	171308	40-71464	338,-	423,-
FZR 1000 Genesis	87-88	171307	40-71340	240,-	300,-
FZR 1000 Genesis	87-88	171300	40-71360	240,-	300,-
XV 1000	86-88	171312	40-71380	295,-	369,-
XV 1000 SE	88	171312	40-71380	295,-	369,-
XV 1000 Virago	86-88	171312	40-71380	295,-	369,-
FJ 1100	84-85	171307	40-71340	240,-	300,-
FJ 1100	84-85	171300	40-71360	240,-	300,-
XS 1100		171300	40-71360	240,-	300,-
XS 1100/ XS 1100 S	78-82	171307	40-71340	240,-	300,-
XS 1100/ XS 1100 S	80-82	171300	40-71360	240,-	300,-
XV 1100 Virago	89>	171312	40-71380	295,-	369,-
XV 1100		171300	40-71360	240,-	300,-
XV 1100	94-98	171312	40-71380	295,-	369,-
XV 1100 SE	91-92	171312	40-71380	295,-	369,-
FJ 1200	86-90	171300	40-71360	240,-	300,-
FJ 1200	86-87	171307	40-71340	240,-	300,-
FJ 1200	91-97	171308	40-71464	295,-	369,-

171301 YAMAHA **OEM nr.**
5Y3-82508-80

171307 YAMAHA
3 polet stik **OEM nr.**
47M-82501-50
3JV-82501-00

171308 YAMAHA **OEM nr.**
3KS-82501-00
3GM-82501-50

171309 YAMAHA **OEM nr.**
3Y6-82501-81

171310 YAMAHA **OEM nr.**
3YL-82501-00
2MA-82501-00

 Tændingslåse
 Tändningslås



171311 YAMAHA



OEM nr.
2NT-82510-01



171315 YAMAHA



OEM nr.
31K-82501-30

171312 YAMAHA



OEM nr.
2AE-82510-00
2AE-82501-00



Beta
the play bike

MADE IN ITALY!

Læs mere på www.betamotor.dk

RR 4T ENDURO 400/450/525

- STEL:** Stålstel.
- MOTOR:** Betamotor. En 398/448/510 cc cylinder. Væskekolet. 4-takt. Keihin karburator. 6 gear.
- HJUL:** For: 21" / 260 mm. bremseskive. Bag: 18" / 240 mm. bremseskive.
- LÆNGDE:** 2270 mm.
- BREDDE:** 820 mm.
- SÆDEHØJDE:** 930 mm.
- TØRVÆGT:** 116,5 kg.
- FORGAFFEL:** 45 mm. hydraulisk USD. Monodæmper bag.



Beta anbefaler
Silkolene
olie!

400-450: **139.995,- / 59.992,-**

525: **145.845,- / 62.095,-**
Ekskl. leveringsomkostninger

Importør: **SCANMI** Tlf. +45 73 15 11 00

Design og produktion  100 % italiensk!

Stikord
Søkd
s. 2-5

Forhandlere
Aterforsäljare
s. 6-9

Tøj/hjelme
Kläder/
hjälm
s. 11

Dæk
Däck
s. 83

Olie
Olja
s. 115

Kæde/
tandhjul
Kedjor/
drev
s. 145

Bremser
Broms
s. 187

Låse
Lås
s. 347

Batteri
Batterier
s. 355

Pakninger
Packingar
s. 377

Motordele
Motordelar
s. 411

Lejer
Lager
s. 435

Karburator
Förgasare
s. 467

El-dele/
Tænding
Elektrisk/
Tänding
s. 509

Blinklygter
Baglygter
Belysning
Baklygter
s. 611

Lyddæmper
Avgassystem
s. 651

Støddæmper
Støtdämpare
s. 681

Luft/
oliefilter
Luft/
oljefilter
s. 711

Kobling
Koppling
s. 769

Kabler
Wire
s. 803

Styr/greb
Styre/
handtag
s. 829

Spejle
og diverse
Speglar
och diverse
s. 867

Bøger/
værktøj
Böcker/
verktyg
s. 893

 Tændingslåse universal / Harley D.
 Tändningslås universal / Harley D.



111084 Universal



 Universal tændingslås, der også passer til Harley Davidson Fat Bob.
 Ref. nr. 07-64020 (40-64020)

Varenr. 111084211,-

 Universaltyp som passar dom flesta hojar men också till Harley Davidson Fat Bob.
 Ref. nr. 07-64020 (40-64020)

Art. nr. 111084264,-

111132 Universal



 Universal tændingslå, med tre poler. En pol monteres med batteriledning, en udgående til tænding og den tredje til tilbehør.
 Ref. nr. 40-64000

Varenr. 111132126,-

 Universaltyp med tre poler. En pol kopplas till batteriet, en utgående till tändningen och den tredje till extra tillbehör.
 Ref. nr. 40-64000

Art. nr. 111132158,-

111131 Universal

 Universal tændingslås, der også passer til Harley Davidson: FX/FXB/FXE/FXEF 78-85, FXLR/FXR/FXS 77, FXSB 85, XLCH/XLH/XLS/XLX 78.

Alle låse har Harley Davidson OEM nr.: 71425-77

Ref. nr. 07-64040

Varenr. 111131126,-

 Universal lås som också passar Harley Davidson: aFX/FXB/FXE/FXEF 78-85 FXLR/FXR/FXS 1977, FXSB 1985 XLCH/XLH/XLSXLX 1978. Alla Harley lås har OEM nr. 71425-77

Ref. nr. 07-64040

Art. nr. 111131158,-



Startrelä

Startrelä

Med et starter relæ fra japanske Tourmax er du godt kørende! Du er sikret kvalitet, stabilitet samt en rigtig god pris.

Med ett startrelä från japanska Tourmax är du gott körande! Du får bra kvalitet, stabilitet samt ett mycket bra pris.



Made in Japan

Mærke/ model	Prod. årg.	Varenr.	Ref.nr.				
Märke/ modell	Prod. årg.	Art.nr.	Ref.nr.	Type	Volt	DKK	SEK
HONDA							
De fleste CB-Honda	71-90	171522	240-412	35850-431007	12 V	319,-	399,-
NES 125	00-06	171519	SSR-101		12 V	425,-	531,-
SES 125	02-04	171519	SSR-101		12 V	425,-	531,-
SH 125	01-04	171519	SSR-101		12 V	425,-	531,-
XL 125 V	07-08	171519	SSR-101		12 V	425,-	531,-
NES 150	00-06	171519	SSR-101		12 V	425,-	531,-
SES 150	02-04	171519	SSR-101		12 V	425,-	531,-
SH 150	03-04	171519	SSR-101		12 V	425,-	531,-
CN 250 R	94-99	171519	SSR-101		12 V	425,-	531,-
CB 600 F	03-06	171519	SSR-101		12 V	425,-	531,-
CBF 600 S	04-06	171519	SSR-101		12 V	425,-	531,-
CBF 600 SA	04-06	171519	SSR-101		12 V	425,-	531,-
CBR 600 F	94	171519	SSR-101		12 V	425,-	531,-
VT 600 C	93-95	171519	SSR-101		12 V	425,-	531,-
XL 650 V	93-04	171519	SSR-101		12 V	425,-	531,-
NTV 650	93-96	171519	SSR-101		12 V	425,-	531,-
CB 750 F2	04-05	171519	SSR-101		12 V	425,-	531,-
RVF 750 R	94-95	171519	SSR-101		12 V	425,-	531,-
VF 750 C	93-97	171519	SSR-101		12 V	425,-	531,-
VFR 750 F	93-97	171519	SSR-101		12 V	425,-	531,-
XR 750	93-00	171519	SSR-101		12 V	425,-	531,-
VRF 800	02-08	171519	SSR-101		12 V	425,-	531,-
VFR 800 A	02-08	171519	SSR-101		12 V	425,-	531,-
VFR 800 F1	98-01	171519	SSR-101		12 V	425,-	531,-
CB 900 F Hornet	02-07	171519	SSR-101		12 V	425,-	531,-
CBR 900 RE	01	171519	SSR-101		12 V	425,-	531,-
CBR 900 RR	93-03	171519	SSR-101		12 V	425,-	531,-
CBR 1000 F	96-99	171519	SSR-101		12 V	425,-	531,-
XL 1000 V	99-08	171519	SSR-101		12 V	425,-	531,-
XL 1000 VA	04-08	171519	SSR-101		12 V	425,-	531,-
CB 1100 SF	00-01	171519	SSR-101		12 V	425,-	531,-
CBR 1100 XX	97-06	171519	SSR-101		12 V	425,-	531,-
ST 1100	94-02	171519	SSR-101		12 V	425,-	531,-
ST 1100 A	93-02	171519	SSR-101		12 V	425,-	531,-
ST 1100 P	03-04	171519	SSR-101		12 V	425,-	531,-
VT 1100 C	94-95	171519	SSR-101		12 V	425,-	531,-
VTR 1100 SP	00-06	171519	SSR-101		12 V	425,-	531,-
CB 1300	05-07	171519	SSR-101		12 V	425,-	531,-
CB 1300 A	05-07	171519	SSR-101		12 V	425,-	531,-
CB 1300 F1	03	171519	SSR-101		12 V	425,-	531,-
CB 1300 F	03	171519	SSR-101		12 V	425,-	531,-
CB 1300 S	05-07	171519	SSR-101		12 V	425,-	531,-
CB 1300 SA	05-07	171519	SSR-101		12 V	425,-	531,-
GL 1500 C	97-03	171519	SSR-101		12 V	425,-	531,-
GL 1500 CD	01-03	171519	SSR-101		12 V	425,-	531,-
GL 1500 CT	97-00	171519	SSR-101		12 V	425,-	531,-
VTX 1800 C1	05-08	171519	SSR-101		12 V	425,-	531,-
VTX 1800 C	02-04	171519	SSR-101		12 V	425,-	531,-

SUZUKI

GS 125 S	Fra 99	171523	SSR-301	AW	12 V	422,-	528,-
GT 185	73-78	171523	SSR-301	GT185	12 V	422,-	528,-
AN 250 Burgmann	98-99	171524	SSR-302	AN	12 V	604,-	755,-
GN 250	82-96	171523	SSR-301	NJ42A	12 V	422,-	528,-
GS 250 TT/TX	80-81	171523	SSR-301		12 V	422,-	528,-
GZ 250 Marauder	Fra 99	171524	SSR-302	AR	12 V	604,-	755,-
GSX 250	80-83	171523	SSR-301	GS25X/GJ53B	12 V	422,-	528,-
GS 300 LZ	82	171523	SSR-301		12 V	422,-	528,-
AN 400 Burgmann	Fra 99	171524	SSR-302	AU	12 V	604,-	755,-
GN 400 /L /TD	80-83	171523	SSR-301	GN400	12 V	422,-	528,-
GS 400 B/C	77-78	171523	SSR-301		12 V	422,-	528,-
GS 400 /E	77-83	171523	SSR-301	GS400	12 V	422,-	528,-
GSX 400 E/ L/ S	80-87	171523	SSR-301	GS40X/GK53C	12 V	422,-	528,-

171519 HONDA

OEM nr.:
SSR-101



171522 HONDA

OEM nr.:
35850-431-007
OEM nr.:
31800-37020



171523 SUZUKI

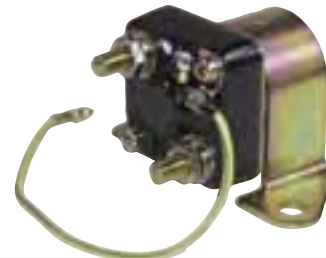

171524 SUZUKI

OEM nr.:
31800-21E20



171550 SUZUKI

OEM nr.:
31800-06G00



Stikord
Sökord
s. 2-5

Forhandlere
Aterforsaljare
s. 6-9

Tøj/hjelme
Klæder/
hjelmar
s. 11

Dæk
Dæk
s. 83

Olie
Olja
s. 115

Kæde/
tandhjul
Kedjor/
drev
s. 145

Bremser
Broms
s. 187

Låse
Lås
s. 347

Batteri
Batterier
s. 355

Pakninger
Packingar
s. 377

Motordele
Motordelar
s. 411

Lejer
Lager
s. 435

Karburator
Förgasare
s. 467

El-dele/
Tænding
Elektrisk/
Tænding
s. 509

Blinklygter
Baglygter
Belysning
Baklygter
s. 611

Lyddæmper
Avgassystem
s. 651

Støddæmper
Støtdåmpare
s. 681

Luft/
oliefilter
Luft/
oljefilter
s. 711

Kobling
Koppling
s. 769

Kabler
Wire
s. 803

Styr/greb
Styre/
handtag
s. 829

Spejle
og diverse
Speglar
och diverse
s. 867

Bøger/
værktøj
Böcker/
verktyg
s. 893

Starter relæ
Startrelä



Mærke/ modell	Prod. årg.	Varenr.	Ref.nr.	Type	Volt	DKK	SEK
------------------	---------------	---------	---------	------	------	-----	-----

Mærke/ modell	Prod. årg.	Art.nr.	Ref.nr.	Type	Volt	DKK	SEK
SUZUKI							
GSX 400 FE Katana	81-83	171523	SSR-301	GS40XF	12 V	422,-	528,-
GS 425 N/EN/LN	79	171523	SSR-301		12 V	422,-	528,-
GS 450 LT/LX/LZ	80-82	171523	SSR-301		12 V	422,-	528,-
GS 450 TX/TZ/TXZ/TXD	81-83	171523	SSR-301		12 V	422,-	528,-
GS 450 ED	83	171523	SSR-301		12 V	422,-	528,-
GS 450 ET/ST/EX/SX/EZ	80-82	171523	SSR-301		12 V	422,-	528,-
GS 450 E/L/S/T	80-83	171523	SSR-301	GS450	12 V	422,-	528,-
GS 450 LD	83	171523	SSR-301		12 V	422,-	528,-
GSX 400 E/L/S GS40X/	80-87	171523	SSR-301	GK53C	12 V	422,-	528,-
GSX 400 FE Katana	81-83	171523	SSR-301	GS40XF	12 V	422,-	528,-
GS 500 E (4 cyl.)	78-79	171523	SSR-301	GS500	12 V	422,-	528,-
S 500 E (2 cyl.)	Fra 00	171524	SSR-302	BK	12 V	604,-	755,-
GS 550 B/C/EC/N/EN	77-79	171523	SSR-301		12 V	422,-	528,-
GS 550 E/L/T	79-82	171523	SSR-301	GS550	12 V	422,-	528,-
GS 550 LN	79	171523	SSR-301		12 V	422,-	528,-
GS 550 ET/TL	80	171523	SSR-301		12 V	422,-	528,-
GS 550 TX	81	171523	SSR-301		12 V	422,-	528,-
GS 550 LX/LZ/MZ	81-82	171523	SSR-301		12 V	422,-	528,-
GS 550 M Katana	81-83	171523	SSR-301	GS550M	12 V	422,-	528,-
GSX 550 E/EF/ES	83-87	171523	SSR-301	GN71D	12 V	422,-	528,-
GT 550	73-77	171523	SSR-301	GT550	12 V	422,-	528,-
GSF 600 N/S Bandit	95-99	171524	SSR-302	GN77B	12 V	604,-	755,-
GSF 600 N/S Bandit	00-04	171524	SSR-302	A8	12 V	604,-	755,-
GSX 600 F	Fra 98	171524	SSR-302	AJ	12 V	604,-	755,-
GSX 600 FW/FX/FY Katana	98-05	171524	SSR-302		12 V	604,-	755,-
RF 600 R	93-96	171524	SSR-302	GN76B	12 V	604,-	755,-
DL 650 V-Strom	04-10	172550	SSR-303	B1	12 V	37,-	46,-
GS 650 EX/EZ	81-82	171523	SSR-301		12 V	422,-	528,-
GS 650 GX/GZ	81-82	171523	SSR-301		12 V	422,-	528,-
GS 650 GLX/GLZ/GLD	81-83	171523	SSR-301		12 V	422,-	528,-
GS 650 MD Katana	83	171523	SSR-301		12 V	422,-	528,-
GS 650 G/Katana	81-83	171523	SSR-301	GS650G	12 V	422,-	528,-
SV 650 N/S	99-02	171524	SSR-302	AV	12 V	604,-	755,-
SV 650 X/Y	99-02	171524	SSR-302		12 V	604,-	755,-
SV 650 N/S	03-10	172550	SSR-303	BY	12 V	37,-	46,-
SX 750 F	Fra 99	171524	SSR-302	AK	12 V	604,-	755,-
GS 750 B/C/EC/N/EN	77-79	171523	SSR-301		12 V	422,-	528,-
GS 750 D/E/L	77-79	171523	SSR-301	GS750	12 V	422,-	528,-
GS 750 LN/LT/LX	79-81	171523	SSR-301		12 V	422,-	528,-
GS 750 ET/EX/EZ	80-82	171523	SSR-301		12 V	422,-	528,-
GS 750 TZ/TD	82-83	171523	SSR-301		12 V	422,-	528,-
GSX 750 E/L	80-82	171523	SSR-301	GS75X	12 V	422,-	528,-
GSX 750 F	Fra 99	171524	SSR-302	AK	12 V	604,-	755,-
GSX 750 S Katana	82-83	171523	SSR-301	GR71A	12 V	422,-	528,-
GSX 750 FW/FX/FY	98-05	171524	SSR-302		12 V	604,-	755,-
GSX 750 Naked	Fra 98	171524	SSR-302	AE	12 V	604,-	755,-
GT 750	73-77	171523	SSR-301	GT750	12 V	422,-	528,-
VL 800 LC Volusia	Fra 01	171524	SSR-302	BM	12 V	604,-	755,-
VZ 800 Marauder	Fra 97	171524	SSR-302	AF	12 V	604,-	755,-
VZ 800 V/W/X/Y	97-05	171524	SSR-302		12 V	604,-	755,-
GS 850 G/GL	79-86	171523	SSR-301	GS72A	12 V	422,-	528,-
GS 850 GN/GT/GX	79-81	171523	SSR-301		12 V	422,-	528,-
GS 850 GLT/GLX	80-81	171523	SSR-301		12 V	422,-	528,-
GS 850 GZ/GD	82-83	171523	SSR-301		12 V	422,-	528,-
GS 850 GLZ/GLD	82-83	171523	SSR-301		12 V	422,-	528,-
RF 900 R/ RS2	94-97	171524	SSR-302	GT73B	12 V	604,-	755,-
RF 900 RT/RV	96-97	171524	SSR-302		12 V	604,-	755,-
DL 1000 V-Strom	02-10	172550	SSR-303	BS	12 V	37,-	46,-
GS 1000 C/EC/N/EN	78-79	171523	SSR-301		12 V	422,-	528,-
GS 1000 E/H/L/S	78-80	171523	SSR-301	GS1000	12 V	422,-	528,-
GS 1000 G/ GL Kardan	80-81	171523	SSR-301	GS100G	12 V	422,-	528,-
GS 1000 ST/ET	80	171523	SSR-301		12 V	422,-	528,-
GS 1000 LN/SN	79	171523	SSR-301		12 V	422,-	528,-
GS 1000 GT/GX	80-81	171523	SSR-301		12 V	422,-	528,-
GS 1000 GLT/GLX	80-81	171523	SSR-301		12 V	422,-	528,-
SV 1000 N/S	03-09	172550	SSR-303	BX	12 V	37,-	46,-
TL 1000 R	Fra 98	171524	SSR-302	AM	12 V	604,-	755,-
TL 1000 RW/RX/RV	98-02	171524	SSR-302		12 V	604,-	755,-
TL 1000 S	Fra 97	171524	SSR-302	AG	12 V	604,-	755,-

171520 YAMAHA

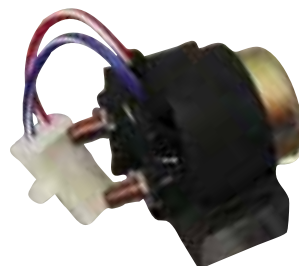

OEM nr.:
4K0-81940-00
3AY-81490-00
22U-82940-10
3H5-81490-00

171521 YAMAHA



OEM nr.:
36Y-81940-00

171525 YAMAHA



OEM nr.:
1J7-81940-10

171551 YAMAHA



OEM nr.:
5JW-81940-02

171552 YAMAHA



OEM nr.:
4KM-81940-00

Startrelä
Startrelä



Märke/ modell	Prod. årg.	Varenr.	Ref.nr.				
Märke/ modell	Prod. årg.	Art.nr.	Ref.nr.	Type	Volt	DKK	SEK
SUZUKI							
TL 1000 SV/SW/SX/SY	97-01	171524	SSR-302		12 V	604,-	755,-
GS 1100 LT	80	171523	SSR-301		12 V	422,-	528,-
GS 1100 ET/EX	80-81	171523	SSR-301		12 V	422,-	528,-
GS 1100 GZ	82	171523	SSR-301		12 V	422,-	528,-
GS 1100 G Kardan	84-86	171523	SSR-301	GU73A	12 V	422,-	528,-
GS 1100 EZ/ED	82-83	171523	SSR-301		12 V	422,-	528,-
GS 1100 GLZ/GLD	82-83	171523	SSR-301		12 V	422,-	528,-
GSX 1100 E/L	80-81	171523	SSR-301	GS110X /GU71B	12 V	422,-	528,-
GSX 1100 SZ Katana	80-85	171523	SSR-301	GS110XS	12 V	422,-	528,-
GSX-R 1100W	Fra 93	171524	SSR-302	GU75C	12 V	604,-	755,-
GSF 1200 Bandit	96-00	171524	SSR-302	GV75A	12 V	604,-	755,-
GSF 1200 Bandit	Fra 01	171524	SSR-302	A9	12 V	604,-	755,-
GSX 1200 Inazuma	Fra 99	171524	SSR-302	A3	12 V	604,-	755,-
GSX-R 1300 Hayabusa	Fra 99	171524	SSR-302	A1	12 V	604,-	755,-
GSX 1400	Fra 01	171524	SSR-302	BN	12 V	604,-	755,-
VL 1500 LC	Fra 98	171524	SSR-302	A	12 V	604,-	755,-
YAMAHA							
SR 125	Fra 96	171520	SSR-201	10F/3MW	12 V	361,-	451,-
XV 125 Virago	97-01	171521	SSR-202	5AJ	12 V	544,-	680,-
XVS 125 Dragstar	Fra 00	171554	SSR-208	VE01	12 V	446,-	558,-
SR 250 SE	80-82	171525	SSR-203	3Y8	12 V	544,-	680,-
SR 250 TH Exciter	81	171525	SSR-203		12 V	544,-	680,-
XS 250	78-80	171525	SSR-203	1U5/3N6/4A2	12 V	544,-	680,-
XV 250 Virago	88-98	171521	SSR-202	3LS/3LW	12 V	544,-	680,-
XVS 250 Drag Star	Fra 01	171554	SSR-208	VG031	12 V	446,-	558,-
YP 250 Majesty	Fra 96	171556	SSR-206	4UC/5DF	12 V	532,-	665,-
XS 360	76-77	171525	SSR-203	1U4	12 V	544,-	680,-
XS 400 OHC	77-82	171525	SSR-203	2A2/4A3	12 V	544,-	680,-
XS 400 SE Special	81-82	171525	SSR-203	4G5	12 V	544,-	680,-
XS 400 DOHC	82-87	171525	SSR-203	12E/12F	12 V	544,-	680,-
ZR 400							
U/SUCW/SWC/A/SAC	88-90	171521	SSR-202		12 V	544,-	680,-
XP 500 T-MAX	01-07	171554	SSR-208	SJ011	12 V	446,-	558,-
XS 500	76-79	171525	SSR-203	1H2	12 V	544,-	680,-
XV 500	83-87	171520	SSR-201	26R	12 V	361,-	451,-
XV 535 Virago T/TC/U	87-88	171520	SSR-201		12 V	361,-	451,-
XV 535 Virago A/AC	90	171520	SSR-201		12 V	361,-	451,-
XV 535 Virago	93-99	171520	SSR-201		12 V	361,-	451,-
XV 535 S Virago	96-97	171520	SSR-201		12 V	361,-	451,-
XV 535 S/SE Virago	88-95	171520	SSR-201	2YL/3BT/3BR	12 V	361,-	451,-
XV 535 S/SE Virago	Fra 96	171520	SSR-201	4MC	12 V	361,-	451,-
XJ 550	81-83	171520	SSR-201	4U8/4V8/27A	12 V	361,-	451,-
XJ 550 H/RJ/RK/Seca	81-83	171520	SSR-201		12 V	361,-	451,-
XZ 550	82-84	171520	SSR-201	11U/11V	12 V	361,-	451,-
FZ 600 S/SC/T/TC/UC	86-88	171521	SSR-202		12 V	544,-	680,-
FZ 6 /S Fazer	04-09	171553	SSR-209	RJ07	12 V	423,-	529,-
XJ 6 F Diversion	10	171554	SSR-208			446,-	558,-
XJ 6 N/S	09-10	171554	SSR-208			446,-	558,-
FZR 600	89-93	171521	SSR-202	3HE/3RG/3RH	12 V	544,-	680,-
FZR 600 RF/RG/RH/RJ/RK	94-98	171521	SSR-202		12 V	544,-	680,-
FZR 600 R	94-95	171556	SSR-206	4JH/4MH	12 V	532,-	665,-
FZS 600 Fazer	98-03	171555	SSR-207	RJ02/5DM	12 V	544,-	680,-
FZS 600 M	00	171555	SSR-207		12 V	544,-	680,-
TT 600 E	94-01	171520	SSR-201		12 V	361,-	451,-
YZF 600 R Thundercat	Fra 96	171556	SSR-206	4TV/4WD	12 V	532,-	665,-
XJ 600 L/LC/N/NC	84-85	171520	SSR-201		12 V	361,-	451,-
XJ 600	84-91	171520	SSR-201	51J/3KM/3KN	12 V	361,-	451,-
XJ 600 N/S Diversion	92-97	171552	SSR-210	4BR/4EB/4LX	12 V	361,-	451,-
XJ 600 N/S Diversion	98-02	171552	SSR-210	RJ01	12 V	361,-	451,-
XT 600							
EA/EAC/EB/EBC/ED/EDC	90-92	171520	SSR-201		12 V	361,-	451,-
XT 600							
EEC/EF/EG/EG/EGC/EH/E	93-02	171520	SSR-201		12 V	361,-	451,-
XT 600 E	90-98	171520	SSR-201	3TB/3UW/4PT	12 V	361,-	451,-
YZF - R6	99-03	171555	SSR-207	5EB/RJ03	12 V	544,-	680,-
YZF - R6	Fra 04	171555	SSR-207	5SL/RJ05	12 V	544,-	680,-
XJ 650	80-83	171520	SSR-201	4K0	12 V	361,-	451,-
XJ 650 Turbo	82-84	171520	SSR-201	11T	12 V	361,-	451,-
XVS 650 Dragstar, 4VR	Fra 97	171553	SSR-209		12 V	423,-	529,-

171553 YAMAHA

OEM nr.:
4BH-81940-00



171554 YAMAHA

OEM nr.:
45V-81940-00



171555 YAMAHA

OEM nr.:
4YR-81940-00



171556 YAMAHA

OEM nr.:
4DN-81940-00



171557 YAMAHA

OEM nr.:
4KG-81940-00



- Stikord Sökord s. 2-5
- Forhandlere Aterforsäljare s. 6-9
- Töj/hjelme Kläder/hjälmor s. 11
- Däck Däck s. 83
- Olje Olja s. 115
- Kæde/ tandhjul Kedjor/ drev s. 145
- Bremser Broms s. 187
- Låse Lås s. 347
- Batteri Batterier s. 355
- Pakninger Packningar s. 377
- Motordele Motordelar s. 411
- Lejer Lager s. 435
- Karburator Förgasare s. 467
- El-dele/ Tænding Elektriskt/ Tänding s. 509
- Blinklygter Baglygter Belysning Baklygter s. 611
- Lyddæmper Avgassystem s. 651
- Støddæmper Støtdåmpare s. 681
- Luft-/ oliefilter Luft-/ oljefilter s. 711
- Kobling Koppling s. 769
- Kabler Wire s. 803
- Styr/greb Styre/ handtag s. 829
- Spejle og diverse Speglar och diverse s. 867
- Bøjer/ værktøj Bøcker/ værktøj s. 893

Starter relæ
Startrelä

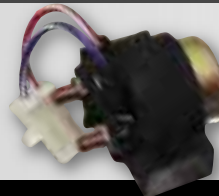

Mærke/ model	Prod. årg.	Varenr.	Ref.nr.				
Märke/ modell	Prod. årg.	Art.nr.	Ref.nr.	Type	Volt	DKK	SEK
YAMAHA							
XVS 650 Dragstar Classic	Fra 98	171553	SSR-209	VM02/VM03	12 V	423,-	529,-
XTZ 660 Tenere	Fra 91	171520	SSR-201	3YF/4MY/4MD	12 V	361,-	451,-
XT 660 R/ X	04-10	171554	SSR-208		12 V	446,-	558,-
MT-03	06-09	171556	SSR-206		12 V	532,-	665,-
FZ 750 N/S/SC	85-86	171521	SSR-202		12 V	544,-	680,-
FZ 750 T/TC/U/UC	87-88	171521	SSR-202		12 V	544,-	680,-
FZ 750	85-93	171521	SSR-202	1FN/2KK/3KT	12 V	544,-	680,-
FZR 750 R	87-88	171521	SSR-202	2TT	12 V	544,-	680,-
FZR 750 R OW01	89-92	171521	SSR-202	3PG/3PH/3PJ	12 V	544,-	680,-
FZX 750	86-89	171521	SSR-202	2JE	12 V	544,-	680,-
XJ 750 J/K/Maxim	82-83	171520	SSR-201		12 V	361,-	451,-
XJ 750 MK Midn. Max.	83	171520	SSR-201		12 V	361,-	451,-
XJ 750 RH/RJ/RK/Seca	81-82	171520	SSR-201		12 V	361,-	451,-
XJ 750	Fra 84	171520	SSR-201	41Y	12 V	361,-	451,-
XJ 750 Seca	82-84	171520	SSR-201	11M	12 V	361,-	451,-
XS 750	77-79	171525	SSR-203	1T5	12 V	544,-	680,-
XS 750 SE/ U.S. Custom	80-82	171525	SSR-203	3L3	12 V	544,-	680,-
XS 750 D/2D/E/F	77-79	171525	SSR-203		12 V	544,-	680,-
XTZ 750 Super Tenere	89-95	171520	SSR-201		12 V	361,-	451,-
XTZ 750 Super tenere	89-97	171520	SSR-201	3LD/3WM	12 V	361,-	451,-
YZF 750 R/ SP	93-98	171556	SSR-206	4HN/4HT	12 V	532,-	665,-
XS 850	80-81	171525	SSR-203	4E2	12 V	544,-	680,-
XS 850 LG/LH Special	80-81	171525	SSR-203		12 V	544,-	680,-
XS 850 SG/SH							
Midnight Special	80-81	171525	SSR-203		12 V	544,-	680,-
TDM 850	91-95	171521	SSR-202	3VD/4CM	12 V	544,-	680,-
TDM 850	96-01	171556	SSR-206	4TX	12 V	532,-	665,-
TRX 850	Fra 96	171556	SSR-206	4UN	12 V	532,-	665,-
TDM 900	Fra 02	171555	SSR-207	5PS/RN08	12 V	544,-	680,-
XJ 900	83-94	171520	SSR-201	31A/58L/4BB	12 V	361,-	451,-
XJ 900 S Diversion	Fra 95	171552	SSR-210	4KM	12 V	361,-	451,-
FZR 1000 Genesis	87-88	171521	SSR-202	2LA/2GH	12 V	544,-	680,-
FZR 1000 B/BC/A/AC/W/MC	89-91	171521	SSR-202		12 V	544,-	680,-
FZR 1000							
D/DC/E/EC/F/FC/G/GC	92-95	171521	SSR-202		12 V	544,-	680,-
FZR 1000 Exup	89-95	171521	SSR-202	3LE/3GM	12 V	544,-	680,-
FZS 1000 Fazer	Fra 01	171555	SSR-207	5LV/RN06	12 V	544,-	680,-
GTS 1000	93-98	171553	SSR-209	4BH	12 V	423,-	529,-
YZF 1000 R Thunderace	Fra 96	171554	SSR-208	4VD/4SV	12 V	446,-	558,-
YZF - R1	98-99	171555	SSR-207	RN01/4XV	12 V	544,-	680,-
YZF - R1	00-01	171555	SSR-207	RN04/5JJ	12 V	544,-	680,-
YZF - R1	02-03	171551	SSR-211	RN09/5PW	12 V	593,-	741,-
YZF - R1	Fra 04	171551	SSR-211	RN12/5VY	12 V	593,-	741,-
BT 1100 Bulldog	Fra 02	171556	SSR-206	RP051	12 V	532,-	665,-
FJ 1100	84-85	171521	SSR-202	47E	12 V	544,-	680,-
XJ 1100 Maxim	82	171520	SSR-201		12 V	361,-	451,-
XJ 1100 J Maxim	82	171525	SSR-203		12 V	544,-	680,-
XS 1100/ XS 1100 S	78-82	171525	SSR-203	2H9/5K7	12 V	544,-	680,-
XS 1100 SF/SG/SH							
Midnight Special	79-81	171525	SSR-203		12 V	544,-	680,-
XVS 1100 Dragstar	Fra 99	171556	SSR-206	5EL/VP05	12 V	532,-	665,-
XVS 1100 A							
Dragstar Classic	Fra 01	171556	SSR-206	5PB/VP16	12 V	532,-	665,-
FJ 1200	86-96	171521	SSR-202	1XJ/3CW/3YA	12 V	544,-	680,-
XJR 1200 /SP	95-98	171557	SSR-204	4PU	12 V	604,-	755,-
XVZ 12 T Venture	83	171520	SSR-201		12 V	361,-	451,-
XVZ 12 TDK Venture R.	83	171520	SSR-201		12 V	361,-	451,-
XVZ 12 L/KC2 Venture	84	171520	SSR-201		12 V	361,-	451,-
XVZ 1200 T							
Venture Royal	84-87	171520	SSR-201	47G	12 V	361,-	451,-
V-Max 1200	85-95	171521	SSR-202	1FK/2WE	12 V	544,-	680,-
V-Max 1200	96-98	171553	SSR-209	2EN/3LR9	12 V	423,-	529,-
V-Max 1200	Fra 99	171553	SSR-209	VP031	12 V	423,-	529,-
XVZ 1200 T/TC/U/UC							
Venture	87-88	171521	SSR-202		12 V	544,-	680,-
NTX 1200 Super Tenere	10	171555	SSR-207		12 V	544,-	680,-
FJR 1300	01-05	171551	SSR-211		12 V	593,-	741,-
FJR 1300 QA	06	171557	SSR-204		12 V	604,-	755,-
FJR 1300 A/VAS ABS	06-09	171555	SSR-207		12 V	544,-	680,-
XJR 1300 /SP	99-01	171557	SSR-204	RP02/RP06	12 V	604,-	755,-
XJR 1300 M	00	171557	SSR-204		12 V	604,-	755,-
XJR 1300 SP	99-01	171557	SSR-204		12 V	604,-	755,-

 Starter relæ
 Startrelä

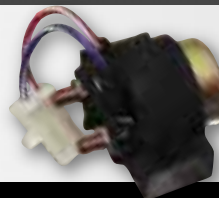

Mærke/ model	Prod. årg.	Varenr.	Ref.nr.				
Märke/ modell	Prod. årg.	Art.nr.	Ref.nr.	Type	Volt	DKK	SEK
YAMAHA							
XVZ 1300 DS/DSC/DT/DTC Venture Royale	86-87	171521	SSR-202		12 V	544,-	680:-
XVZ 1300 TD Venture Royal	88-96	171521	SSR-202	3JS/3JT	12 V	544,-	680:-
XVZ 1300 A Royal Star	Fra 96	171553	SSR-209	4YP	12 V	423,-	529:-
XVZ 1300 AT Tour Classic	Fra 99	171553	SSR-209	4NK/4NL	12 V	423,-	529:-
XVZ 1300 TF Royal Star Vent.	Fra 99	171553	SSR-209	5JC	12 V	423,-	529:-
XV 1600 Wild Star	Fra 99	171553	SSR-209	5JA/VP08	12 V	423,-	529:-
XV 1700 Warrior	03-04	171555	SSR-207		12 V	544,-	680:-
XV 1700 Road Star Warrior	Fra 03	171553	SSR-209		12 V	423,-	529:-
V-Max 1700	09-10	171554	SSR-208		12 V	446,-	558:-
XV 1900 Midnight Star		171551	SSR-211		12 V	593,-	741:-

Stikord
Sökord
s. 2-5

Forhandlere
Aterforsäljare
s. 6-9

Tøj/hjelme
Kläder/
hjälmår
s. 11

Dæk
Däck
s. 83

Olje
Olja
s. 115

Kæde/
tandhjul
Kedjor/
drev
s. 145

Bremser
Broms
s. 187

Låse
Lås
s. 347

Batteri
Batterier
s. 355

Pakninger
Packningar
s. 377

Motordele
Motordelar
s. 411

Lejer
Lager
s. 435

Karburator
Förgasare
s. 467

El-dele/
Tænding
Elektrisk/
Tänding
s. 509

Blinklygter
Baglygter
Belysning
Baklygter
s. 611

Lyddæmper
Avgassystem
s. 651

Støddæmper
Støtdämpare
s. 681

Luft/
oliefilter
Luft/
oljefilter
s. 711

Kobling
Koppling
s. 769

Kabler
Wire
s. 803

Styr/greb
Styre/
handtag
s. 829

Spejle
og diverse
Speglar
och diverse
s. 867

Bøger/
værktøj
Böcker/
verktyg
s. 893



Beta
the play bike

URBAN 200

STEL: Stålstel.
MOTOR: Minarellmotor.
Luftkølet. En 199 cc cylinder.
4-takt. Mikuni karburator.
5 gear.
HJUL: For: 19" / 245 mm. bremseskive.
Bag: 16" / 220 mm. bremseskive.
LÆNGDE: 2010 mm.
BREDDE: 800 mm.
SÆDEHØJDE: 830 mm.
TØRVÆGT: 110 kg.
FORGAFFEL: 38 mm. hydraulisk.
Monodæmper bag.

54.993,-
Ekskl. leveringsomkostninger

Importør: **SCANMI** Tlf. +45 73 15 11 00

MADE IN ITALY!

Læs mere på www.betamotor.dk



Beta anbefaler **Silkolene** olie!

Design og produktion  100 % italiensk!



HYOSUNG

made in Korea

GT 250 racer



8001039 Vit

Motor: Luft/oljakyld, DOHC, 8 ventiler, 75° V-twin.
Slagvolym: 249 cc.
Borrning/Slag: 57 x 48,8.
Kompression: 10,3 : 1.
Max effekt: 29 HK.
Max vridmoment: 21 Nm vid 6750 rpm.
Bränslesystem: Insprutning.
Smöring: Våtsump.
Koppling: Våt, flerskivig.
Växlar: 5.
Broms: Fram: Dubbla 300 mm skivor. Bak: Enkel 230 mm skiva.
Fjädring: Fram: 41 mm Upside down.
Bak: Justerbar monodämpare.
Däck: Fram: 110/70-17. Bak: 150/70-17.
LxBxH: 2090 x 700 x 1130 mm.
Hjulbas: 1435 mm.
Markfrigång: 155 mm.
Sadelhöjd: 830 mm.
Sluttransmission: Kedja.
Vikt: 188 kg.

Hyosung använder olja från
Silkolene



46.900:-



Hitta din närmaste återförsäljare och läs mer på

www.hyosung.se 

Mycket mer motorcykel för pengarna! ...

Ensretter/voltregulatorer

Nye ensrettere, med samme spesifikationer som de originale. Fremstillet på samme fabrik i Japan. Alle stik passer på det originale ledningsnet. High quality - Made in Japan.

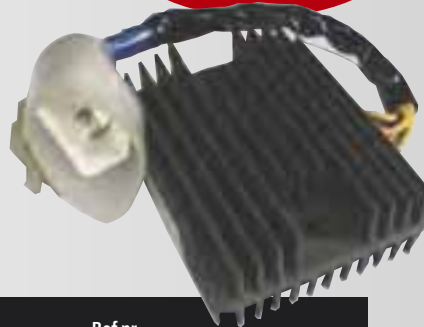

Likriktare/voltregulator

Nya likriktare med samma specifikationer som originalet eftersom de är utvecklade på samma japanska fabrik. Alla kontakter/stik passar på motorcykelns originalkablar.

Märke/model	Type	Prod. årg.	Ensrettere/Regulator Varenr.	Regulator OEM nr.	Ref.nr.		
Märke/modell	Typ	Prod. årg.	Likriktare/Regulator Art.nr.	Regulator OEM nr.	Ref.nr.	DKK	SEK
HONDA							
CB 250 T1/T2		78-80	098610		RGU-101	733,-	916:-
CB 250 (Two Fifty)			098620		RGU-130	746,-	933:-
CB 250 T/N Eurosport	CB250N/T	77-82	098610	31600-413/MC9-008/740	RGU-101	733,-	916:-
CB 250 RS	MC02	80-83	098610	31600-413/MC9-008/740	RGU-101	733,-	916:-
CJ 250 T	CJ250T	77-79	098610	31600-413/MC9-008/740	RGU-101	733,-	916:-
CL 250 S	MD04	82-84	098610	31600-413/MC9-008/740	RGU-101	733,-	916:-
CM/CMX 250 C/Rebell	MC06/13	80-87	098610	31600-413/MC9-008/740	RGU-101	733,-	916:-
CMX 250 Rebell	MC13/32	96-99	098654	31600-KR3-980	RGU-160	685,-	856:-
FES 250 Foresight	MF04A	Fra 98	098605	31600-MV4-000	RGU-107	835,-	1044:-
NX 250	MD21	88-90					
CB 350 Four	CB350F	73-74	098606	31700-333-008	RGU-112	636,-	795:-
TRX 350 FE/FM/TE/TM		00-03	098632	31600-HN5-671	RGU-146	770,-	963:-
CB 400 Four	CB400F	75-79	098606	31700-333-008	RGU-112	636,-	795:-
CB 400 F (CB1)	NC27	Fra 89	098604	31600-KY2-703	RGU-106R	810,-	1013:-
CB 400 T/N Eurosport	CB400T/N	77-84	098610	31600-413/MC9-008/740	RGU-101	733,-	916:-
CB 400 T Hawk	US-VERSION			31600-413-008 (6 PINS)			
CB 400 Super Four	NC31		098605		RGU-107	835,-	1044:-
CB 450 SC Nighthawk		85-88	098610		RGU-101	733,-	916:-
CB 450 Hawk		82>	098610		RGU-101	733,-	916:-
CM 450 C Custom		82>	098610		RGU-101	733,-	916:-
CBR 400 RR	NC23		098604	31600-KY2-703	RGU-106R	810,-	1013:-
CBR 400 RR/RRN/RRR	NC29		098605		RGU-107	835,-	1044:-
CM 400 T	NC01	80-84	098610	31600-413/MC9-008/740	RGU-101	733,-	916:-
TRX 400 FW		01-03	098632	31600-HN5-671	RGU-146	770,-	963:-
VFR 400 R	NC30	90-92	098604	31600-KY2-703	RGU-106R	810,-	1013:-
CB 450 N/S	PC14/17	85-88	098610	31600-413/MC9-008/740	RGU-101	733,-	916:-
TRX 450 ES/S		01-03	098632	31600-HN5-671	RGU-146	770,-	963:-
CB 500/ CB 500 S	PC26/PC32	93-03	098605	31600-MV4-000	RGU-107	835,-	1044:-
CBF 500	PC39	Fra 04	098633	31600-KFG-861	RGU-150	703,-	879:-
CB 500 Four	CB500F	70-76	098606	31700-333-008	RGU-112	636,-	795:-
CX 500 DA		80	098618		RGU-128	831,-	1039:-
CX 500	CX500	77-83	098618	31600-415-008	RGU-128	831,-	1039:-
CX 500 C Custom	PC01	80-84	098618	31600-415-008	RGU-128	831,-	1039:-
CX 500 E Euro	PC06	82-86	098601	31600-MB0/MB3-000/008	RGU-103	1018,-	1273:-
CX 500 T Turbo	PC03	81-82	098601	31600-MB0/MB3-000/008	RGU-103	1018,-	1273:-
FT 500	PC07	82-85	098610	31600-413/MC9-008/740	RGU-101	733,-	916:-
GB 500 Clubman	PC16	Fra 88	098610	31600-413/MC9-008/740	RGU-101	733,-	916:-
GL 500 D Silverwing	PC02	80-84	098601	31600-MB0/MB3-000/008	RGU-103	1018,-	1273:-
VF 500 F/FII	PC12	84-86	098623	31600-MF2-000	RGU-133	964,-	1205:-
VT 500 C/E	PC08/11	83-86	098601	31600-MB0/MB3-000/008	RGU-103	1018,-	1273:-
XBR 500	PC15	85-91	098610	31600-413/MC9-008/740	RGU-101	733,-	916:-
CB 550 F Supersport	CB550F	75-80	098606	31700-333-008	RGU-112	636,-	795:-
CB 550 K3	CB550K3	77-78	098606	31700-333-008	RGU-112	636,-	795:-
CBX 550 F/FII	PC04	82-86	098602	31600-461/MA6-771/000	RGU-104	1000,-	1250:-
CB 600 F/S Hornet	PC34	98-01	098605	31600-MV4-000	RGU-107	835,-	1044:-
CB 600 F/S Hornet	PC36	02-07	098633	31600-KFG-861	RGU-150	703,-	879:-
CB 600 F/FA		07-08	098652		RGU-166	1060,-	1325:-
CBF 600 N/S	PC38	Fra 04	098633	31600-KFG-861	RGU-150	703,-	879:-
CBF 600 N/NA/S/SA		08-09	098652		RGU-166	1060,-	1325:-
CBR 600 F	PC19/PC23	87-90	098640	31600-MN4-018	RGU-122	824,-	1030:-
CBR 600 F	PC25/PC31	91-98	098605	31600-MV4-000	RGU-107	835,-	1044:-
CBR 600 F	PC35	99-00	098605	31600-MV4-000	RGU-107	835,-	1044:-
CBR 600 F/ FS	PC35	01-04	098616	31600-MBW-D21	RGU-126	1135,-	1419:-
CBR 600 F4		01	098617		RGU-127	1087,-	1359:-
CBR 600 RR	PC37	Fra 03	098636	31600-MEE-003	RGU-154	1089,-	1361:-
FJS 600 Silverwing	PF01	Fra 02	098643	31600-MEF-003	RGU-163	1210,-	1513:-
VT 600 C Shadow	PC21	Fra 88	098609	31600-MY0-771	RGU-115	879,-	1099:-
VT 600 CD Shadow de Luxe		93-98	098609		RGU-115	879,-	1099:-
XL 600 V Transalp	PD06	87-90	098624	31600-MM9-000	RGU-138	835,-	1044:-
XL 600 V Transalp	PD06	Fra 91	098625	31600-MS6-921	RGU-144	879,-	1099:-
CB 650 J/C/SC	RC03/05/08	78-82	098644	31600-460-731	RGU-136	1085,-	1356:-
CB 650		83-86	098645	31600-ME5-013	RGU-116	1061,-	1326:-

- Stikord Sökord s. 2-5
- Forhandlere Aterforsaljare s. 6-9
- Tøj/hjelme Klæder/hjælmar s. 11
- Dæk Däck s. 83
- Olje Olja s. 115
- Kæde/tandhjul Kedjor/drev s. 145
- Bremser Broms s. 187
- Låse Lås s. 347
- Batteri Batterier s. 355
- Pakninger Packningar s. 377
- Motordele Motordelar s. 411
- Lejer Lager s. 435
- Karburator Förgasare s. 467
- El-dele/Tænding Elektriskt/Tænding s. 509
- Blinklygter Baglygter Belysning Baklygter s. 611
- Lyddæmper Avgassystem s. 651
- Støddæmper Støtdæmpare s. 681
- Luft-/oliefilter Luft-/oljefilter s. 711
- Kobling Koppling s. 769
- Kabler Wire s. 803
- Styr/greb Styre/håndtag s. 829
- Spejle og diverse Speglar och diverse s. 867
- Bøger/værktøj Bøcker/verktøy s. 893

Ensretter/voltregulatorer
Likriktare/voltregulator



Mærke/ model	Type	Prod. årg.	Ensrettere/Regulator Varenr.	OEM nr.	Ref.nr.		
Märke/ modell	Typ	Prod. årg.	Likriktare/Regulator Art.nr.	OEM nr.	Ref.nr.	DKK	SEK
HONDA							
CBX 650 E	RC13	Fra 83	098602	31600-461/MA6-771/000	RGU-104	1000,-	1250:-
CX 650 C/E/T	RC11/12/16	Fra 82	098601	31600-MB0/MB3-000/008	RGU-103	1018,-	1273:-
FX 650		99-00	098635		RGU-152	736,-	920:-
GL 650 D Silverwing	RC10	83-84	098601	31600-MB0/MB3-000/008	RGU-103	1018,-	1273:-
NT 650 Hawk	RC31	88-91	098609	31600-MY0-771	RGU-115	879,-	1099:-
NT 650 V Deauville	RC47	98-04	098605	31600-MV4-000	RGU-107	835,-	1044:-
NTV 650 Revere	RC33	88-97	098634	31600-MS9-003	RGU-151	1013,-	1266:-
NX 650 Dominator	RD08	95-00	098646	31600-MAN-621	RGU-158	733,-	916:-
SLR/FX 650 Vigor	RD09	97-00	098635	31600-MAK-000	RGU-152	736,-	920:-
XL 650 V Transalp	RD10	00-01	098632	31600-HN5-671	RGU-146	770,-	963:-
XR 650 R	RE01	01-06	098647	31600-MBN-651	RGU-161	714,-	893:-
XRV 650 Africa-Twin	RD03	88-89	098613	31600-MS8-000	RGU-123	714,-	893:-
VF 700 F / Interceptor		84-86	098601		RGU-103	1018,-	1273:-
CB 750 Four KO-7	CB750K	69-78	098606	31700-333-008	RGU-112	636,-	795:-
CB 750 F2 Super-Sport	CB750G	77-78	098606	31700-333-008	RGU-112	636,-	795:-
CB 750 F/II Bol d'Or	RC04	79-80	098603	31600-425/MA6-008/910	RGU-105	1000,-	1250:-
CB 750 C/F/II Bol d'Or	RC04/06	81-84	098602	31600-461/MA6-771/000	RGU-104	1000,-	1250:-
CB 750 K	RC01	79-80	098603	31600-425/MA6-008/910	RGU-105	1000,-	1250:-
CB 750 K	RC01	81-82	098602	31600-461/MA6-771/000	RGU-104	1000,-	1250:-
CB 750 SC		82-84	098602		RGU-104	1000,-	1250:-
CB 750 Seven Fifty	RC42	Fra 92	098607	31600-MS2-604	RGU-113	661,-	826:-
CBX 750 F/ II	RC17	Fra 84	098644	31600-460-731	RGU-136	1085,-	1356:-
VF 750 Magna		94-00	098641		RGU-121	812,-	1015:-
VF 750 C/F/S	RC07/09/15	82-92	098601	31600-MB0/MB3-000/008	RGU-103	1018,-	1273:-
VF 750 C	RC43	93-99	098641	31600-MZ5-003	RGU-121	812,-	1015:-
VFR 750 F	RC36	90-97	098611	31600-MY7/MT4-600/008	RGU-118	940,-	1175:-
VT 750/700 C (US)	RC14	83-85	098649	31600-ME9-008	RGU-135	1210,-	1513:-
VT 750 C	RC29	87-89	098601	31600-MB0/MB3-000/008	RGU-103	1018,-	1273:-
VT 750 C2 Shadow ACE	RC44	97-00	098605	31600-MV4-000	RGU-107	835,-	1044:-
VT 750 C2 Shadow ACE	RC44	01-02	098633	31600-KFG-861	RGU-150	703,-	879:-
VT 750 DC Black Widow	RC48	00-02	098605	31600-MV4-000	RGU-107	835,-	1044:-
XRV 750 Africa-Twin	RD04	90-92	098614	31600-MV1-003	RGU-124	861,-	1076:-
XRV 750 Africa-Twin	RD07	93-00	098615	31600-MY1-003	RGU-125	847,-	1059:-
PC 800 Pacific Coast	RC34	Fra 89	098605	31600-MV4-000	RGU-107	835,-	1044:-
VFR 800 FI	RC46/1	00-01	098627	31600-MBG-D00	RGU-142	1210,-	1513:-
VFR 800 ABS	RC46/2	02-03	098629	31600-MCW-D01	RGU-143	1210,-	1513:-
VFR 800 ABS	RC46/2	04-09	098631	31600-MCW-D61	RGU-148	1210,-	1513:-
CB 900 F Bol d'Or	SC01	79-80	098603	31600-425/MA6-008/910	RGU-105	1000,-	1250:-
CB 900 C		81>	098602		RGU-104	1000,-	1250:-
CB 900 F/ II Bol D'Or	SC09	81-84	098602	31600-461/MA6-771/000	RGU-104	1000,-	1250:-
CB 900 Hornet	SC48	02-03	098637	31600-MCZ-003	RGU-155	1210,-	1513:-
CB 900 Hornet		04-08	098653		RGU-168	1480,-	1850:-
CBR 900 RR	SC28/SC33	92-99	098605	31600-MV4-000	RGU-107	835,-	1044:-
CBR 900 RR	SC44	00-01	098612	31600-MCJ-641	RGU-117	1121,-	1401:-
CBR 900 RR	SC50	02-03	098628	31600-MCJ-750	RGU-140	1061,-	1326:-
CB 1000 F Big One	SC30	93-96	098607	31600-MS2-604	RGU-113	661,-	826:-
CBR 1000 F	SC21	87-89	098644	31600-460-731	RGU-136	1085,-	1356:-
CBR 1000 F	SC24	90-99	098607	31600-MS2-604	RGU-113	661,-	826:-
CBR 1000 RR	SC57	Fra 04	098642	31600-MEL-013	RGU-164	830,-	1038:-
CBX 1000	CB1	78-79	098603	31600-425/MA6-008/910	RGU-105	1000,-	1250:-
CBX 1000 /Pro Link	SC03/06	80-82	098602	31600-461/MA6-771/000	RGU-104	1000,-	1250:-
GL 1000 Gold-Wing	GL1/GL2	75-79	098600	31600-463/MG9-008/010	RGU-102	1049,-	1311:-
VF 1000 F/ FII/ R	SC15/16	84-86	098601	31600-MB0/MB3-000/008	RGU-103	1018,-	1273:-
VTR 1000 F	SC36	Fra 97	098605	31600-MV4-000	RGU-107	835,-	1044:-
VTR 1000 SP1	SC45	00-01	098617	31600-MCF-003	RGU-127	1087,-	1359:-
VTR 1000 SP2	SC45	02-06	098650	31600-MCF-D30	RGU-162	1210,-	1513:-
XL 1000 V Varadero	SD01/02A	Fra 99	098605	31600-MV4-000	RGU-107	835,-	1044:-
XL 1000 V		03-04	098638		RGU-156	1210,-	1513:-
CB 1100 F	SC11	81-85	098602	31600-461/MA6-771/000	RGU-104	1000,-	1250:-
CB 1100 R	SC05/08	81-83	098602	31600-461/MA6-771/000	RGU-104	1000,-	1250:-
CB 1100 SF X-Eleven	SC42	Fra 00	098608	31600-MAT-E01	RGU-114	1121,-	1401:-
CBR 1100 XX	SC35	97-98	098611	31600-MY7/MT4-600/008	RGU-118	940,-	1175:-
CBR 1100 XX	SC35	99-00	098608	31600-MAT-E01	RGU-114	1121,-	1401:-
CBR 1100 XX	SC35	01-03	098630	31600-MAT-D51	RGU-147	1210,-	1513:-
GL 1100 Gold-Wing	SC02	80-83	098600	31600-463/MG9-008/010	RGU-102	1049,-	1311:-
GL 1100 A/C/D Aspencade		82-83	098600		RGU-102	1049,-	1311:-
GL 1100 A-D Interstate		80-83	098600		RGU-102	1049,-	1311:-
ST 1100 Pan European	SC26	Fra 90	098607	31600-MS2-604	RGU-113	661,-	826:-
VF 1100 C	SC12	83-86	098601	31600-MB0/MB3-000/008	RGU-103	1018,-	1273:-
VT 1100 C Shadow	SC23	88-95	098619	31600-MAA-000	RGU-129	895,-	1119:-
VT 1100 C2 ACE	SC32	95-97	098622	31600-MAH-008	RGU-132	899,-	1124:-

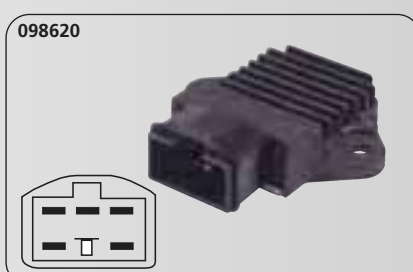
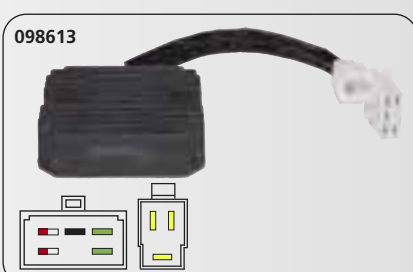
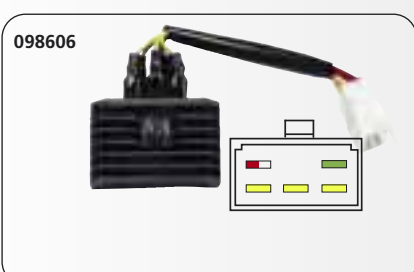
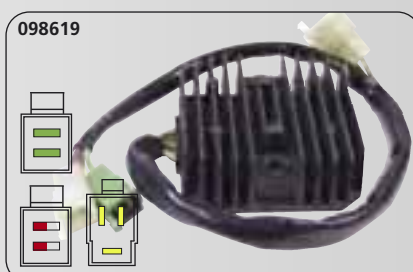
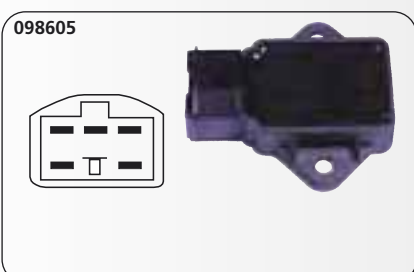
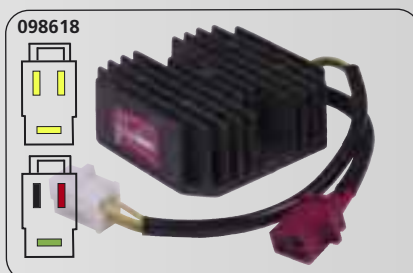
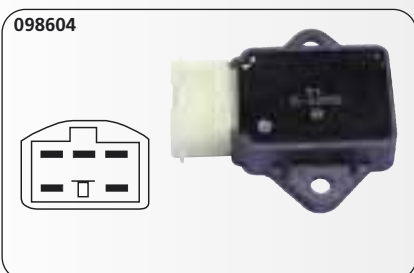
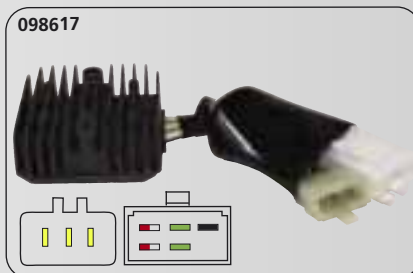
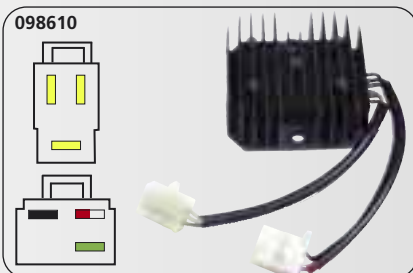
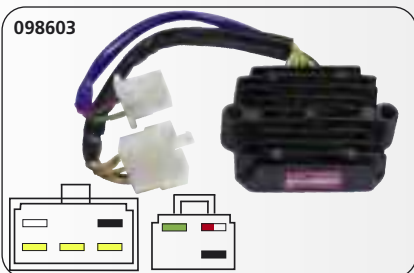
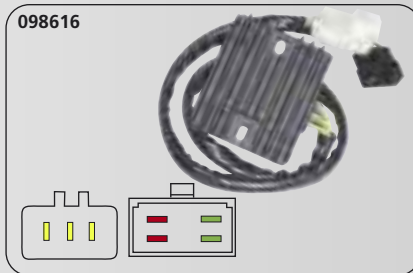
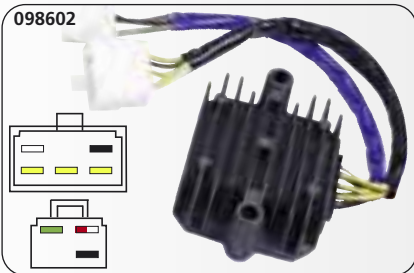
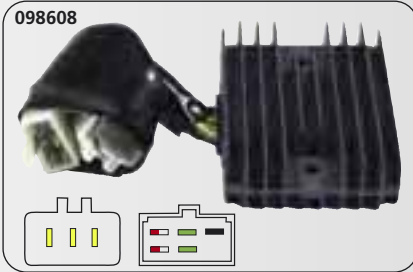
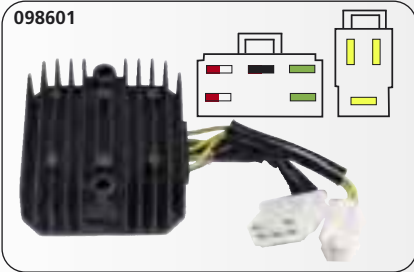
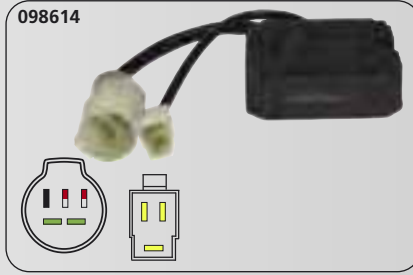
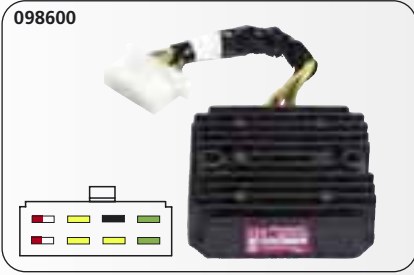

Stikord
Sökord
s. 2-5

Forhandlere
Aterforsäljare
s. 6-9

Tøj/hjelme
Kläder/
hjälmnar
s. 11

Dæk
Däck
s. 83

Olje
Olja
s. 115

Kæde/
tandhjul
Kedjor/
drev
s. 145

Bremser
Broms
s. 187

Låse
Lås
s. 347

Batteri
Batterier
s. 355

Pakninger
Packningar
s. 377

Motordele
Motordelar
s. 411

Lejer
Lager
s. 435

Karburator
Förgasare
s. 467

**El-dele/
Tænding
Elektriskt/
Tænding
s. 509**

Blinklygter
Baglygter
Belysning
Baklygter
s. 611

Lyddæmper
Avgassystem
s. 651

Støddæmper
Støtdämpare
s. 681

Luft-/
oliefilter
Luft-/
oljefilter
s. 711

Kobling
Koppling
s. 769

Kabler
Wire
s. 803

Styr/greb
Styre/
handtag
s. 829

Spejle
og diverse
Speglar
och diverse
s. 867

Bøger/
værktøj
Böcker/
verktyg
s. 893

Ensretter/voltregulatorer
Likriktare/voltregulator



Mærke/ model	Type	Prod. årg.	Ensrettere/Regulator Varenr.	OEM nr.	Ref.nr.		
Mærke/ modell	Typ	Prod. årg.	Likriktare/Regulator Art.nr.	OEM nr.	Ref.nr.	DKK	SEK
HONDA							
GL 1200 Gold Wing	SC14	84	098600	31600-463/MG9-008/010	RGU-102	1049,-	1311:-
GL 1200 Gold Wing	SC14	85-86	098626	31600-ML8-305	RGU-139	1210,-	1513:-
CB 1300 S		05-07	098651		RGU-165	1210,-	1513:-
KAWASAKI							
KL 250 D2-D6/KLR 250		85-89	098706		RGU-407	604,-	755:-
KL 250 D7-D11		90-93	098706		RGU-407	604,-	755:-
KL 250 D12-D15		93-98	098706		RGU-407	604,-	755:-
KDX 200		92-02	098717	21066-1072	RGU-416	750,-	938:-
KDX 220		Fra 00	098717	21066-1072	RGU-416	750,-	938:-
BJ 250 Estrella	BJ250A/C	91-96	098701	21066-1030	RGU-402	812,-	1015:-
EL 250 Eliminator	EL250B/E	88-95	098701	21066-1030	RGU-402	812,-	1015:-
GPZ 250	EX250E/F	86-00	098701	21066-1030	RGU-402	812,-	1015:-
KFX 250 Mojave	KSF250	00-04	098717	21066-1072	RGU-416	750,-	938:-
KLR 250	KL250D	84-93	098706	21066-1052	RGU-407	604,-	755:-
Z 250 C/ LTD (1 cyl.)	KZ250C/G	79-82	098715	21066-029	RGU-410	706,-	883:-
Z 250 (2 cyl.)	KZ250A	79-82	098715	21066-029	RGU-410	706,-	883:-
EL 252 Eliminator	EL250F	Fra 96	098701	21066-1030	RGU-402	812,-	1015:-
KLX 300		97-01	098717	21066-1072	RGU-416	750,-	938:-
GPZ 400 Unitrak	ZX400A	84-85	098701	21066-1030	RGU-402	812,-	1015:-
KH 400	S3	76-77	098715	21066-029	RGU-410	706,-	883:-
Z 400 B/C (2Zyl.)	K4/K4G	74-80	098715	21066-029	RGU-410	706,-	883:-
Z 400 GP (4 Zyl.)	KZ400M	83-84	098701	21066-1030	RGU-402	812,-	1015:-
Z 400 J (4 Zyl.)	KZ400J	82-83	098705	21066-1008	RGU-406	1121,-	1401:-
ZXR 400	ZX400L1-3	91-93	098702	21066-1055/-1101	RGU-403	725,-	906:-
ZXR 400	ZX400L4-L9	94-99	098703	21066-1089	RGU-404	812,-	1015:-
ZXR 400 H1/H2		89-90	098702		RGU-403	725,-	906:-
ZXR 400 J1/J2		89-90	098702		RGU-403	725,-	906:-
Z 440	KZ440C/H	80-83	098704	21066-1014	RGU-405	725,-	906:-
Z 440 LTD/ Custom	KZ440A/D	80-84	098704	21066-1014	RGU-405	725,-	906:-
Z 450 LTD	EN450A	85-89	098701	21066-1030	RGU-402	812,-	1015:-
EN 500	EN500A/B/C	Fra 90	098701	21066-1030	RGU-402	812,-	1015:-
ER 5 Twister	ER500A/D	97-03	098711	21066-1098	RGU-418	758,-	948:-
GPZ 500 S	EX500A/D	Fra 87	098701	21066-1030	RGU-402	812,-	1015:-
KH 500 MACH III	H1	69-77	098715	21066-029	RGU-410	706,-	883:-
KLE 500	LE500A	Fra 91	098701	21066-1030	RGU-402	812,-	1015:-
Z 500 B	KZ500B	79-80	098715	21066-029	RGU-410	706,-	883:-
GPZ 550/ Z 550 GP	KZ550H	82-83	098701	21066-1030	RGU-402	812,-	1015:-
GPZ 550 Unitrak	ZX550A	84-89	098707	21066-1038	RGU-408	1210,-	1513:-
GT 550/ Z 550 GT	KZ550G	83-94	098701	21066-1030	RGU-402	812,-	1015:-
Z 550 F Unitrak	KZ550B-B	83-84	098701	21066-1030	RGU-402	812,-	1015:-
Z 550 GP	KZ550D	81	098705	21066-1008	RGU-406	1121,-	1401:-
Z 550 LTD	KZ550C	80-89	098701	21066-1030	RGU-402	812,-	1015:-
ZR 550	KZ550A	80-83	098705	21066-1008	RGU-406	1121,-	1401:-
ZR 550 Zephyr	ZR550B	91-95	098707	21066-1038	RGU-408	1210,-	1513:-
ZR 550 Zephyr	ZR550B	96-99	098711	21066-1098	RGU-418	758,-	948:-
ZR 550 A		80-83	098705		RGU-406	1121,-	1401:-
ER 6 N/ F		Fra 05	098713	21066-1127	RGU-417	659,-	824:-
GPX 600 R	ZX600C1-6	88-93	098702	21066-1055/-1101	RGU-403	725,-	906:-
GPX 600 R	ZX600C7-10	94-97	098703	21066-1089	RGU-404	812,-	1015:-
GPZ 600 R	ZX600A	85-90	098702	21066-1055/-1101	RGU-403	725,-	906:-
KL 600 A1 / KLR 600		84	098706		RGU-407	604,-	755:-
KL 600 B1-B2 KLR		85-89	098707		RGU-408	1210,-	1513:-
KLR 600	KL600A	84	098706	21066-1052	RGU-407	604,-	755:-
KLR 600	KL600B	85-89	098707	21066-1038	RGU-408	1210,-	1513:-
ZL 600 Eliminator	ZL600A	86-88	098702	21066-1055/-1101	RGU-403	725,-	906:-
ZL 600 Eliminator	ZL600B	95-97	098703	21066-1089	RGU-404	812,-	1015:-
ZX 6 R	ZX600F	95-97	098703	21066-1089	RGU-404	812,-	1015:-
ZX 6 R	ZX600G	98-99	098708	21066-1099	RGU-413	917,-	1146:-
ZX 6 R	ZX600J	00-02	098709	21066-1125	RGU-415	1210,-	1513:-
ZX 6 RR	ZX600K	03-04	098712	21066-0002	RGU-419	918,-	1148:-
ZX 636 R	ZX636A	02	098709	21066-1125	RGU-415	1210,-	1513:-
ZX 636 R	ZX636B	03-04	098712	21066-0002	RGU-419	918,-	1148:-
ZZR 600	ZX600D1	90	098702	21066-1055/-1101	RGU-403	725,-	906:-
ZZR 600	ZX600D2-4	91-93	098716	21066-1083	RGU-411	957,-	1196:-
ZZR 600	ZX600E	93-04	098703	21066-1089	RGU-404	812,-	1015:-
ZZR 600	ZX600E	05-06	098709	21066-1125	RGU-415	1210,-	1513:-
KL 650 Tengai	KL650B	89-93	098707	21066-1038	RGU-408	1210,-	1513:-
KLR 650	KL650A	Fra 87	098707	21066-1038	RGU-408	1210,-	1513:-
Z 650 B	KZ650B/C	77-79	098715	21066-029	RGU-410	706,-	883:-
Z 650 F	KZ650F	80-83	098704	21066-1014	RGU-405	725,-	906:-
Z 650 CSR	KZ650H	81-83	098705	21066-1008	RGU-406	1121,-	1401:-
Z 650 LTD	KZ650E/L	80-83	098704	21066-1014	RGU-405	725,-	906:-
Z 650 SR	KZ650D	79-80	098715	21066-029	RGU-410	706,-	883:-

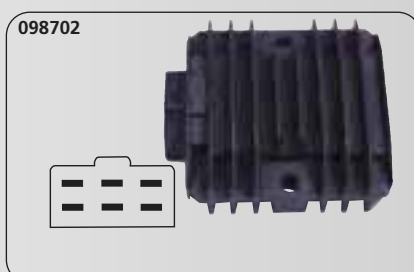
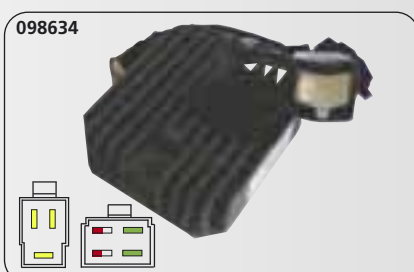
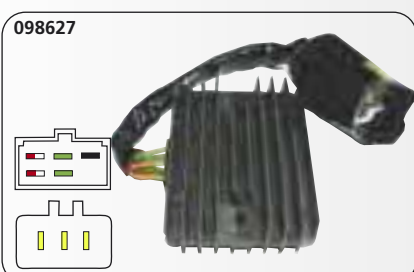
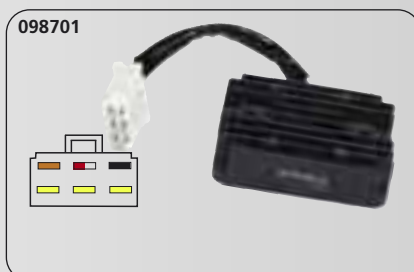
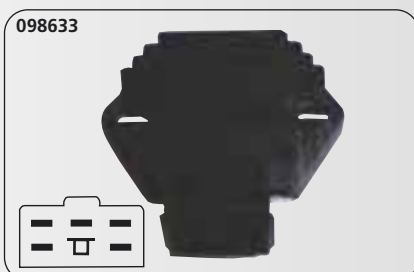
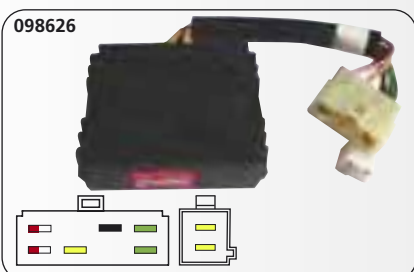
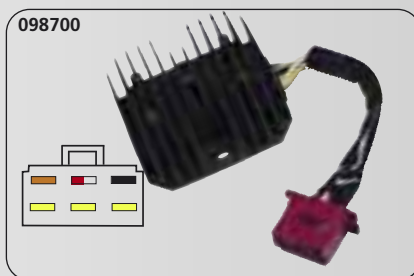
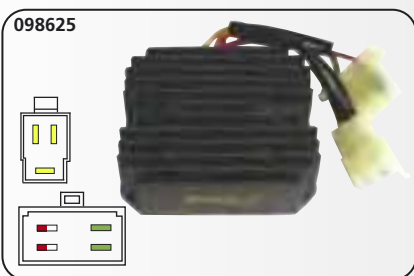
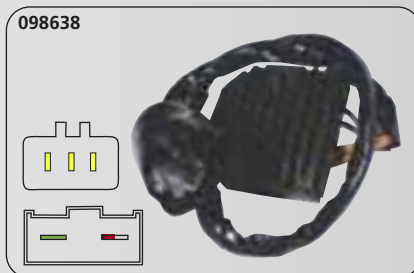
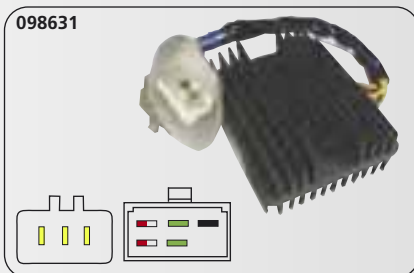
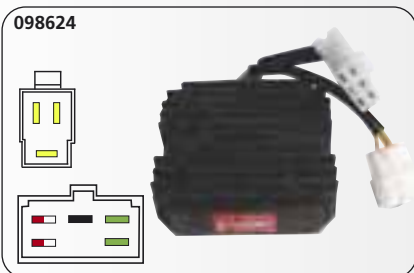
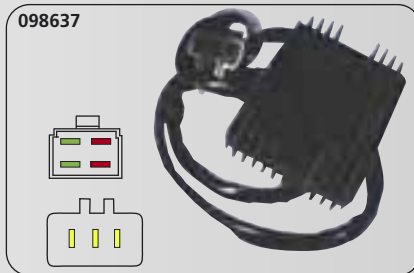
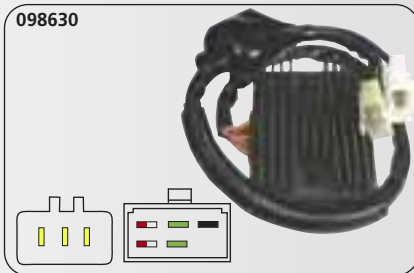
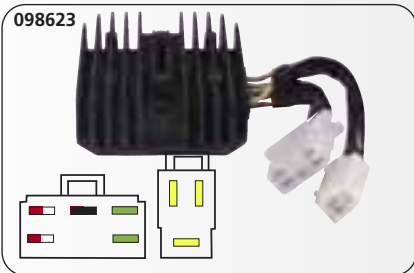
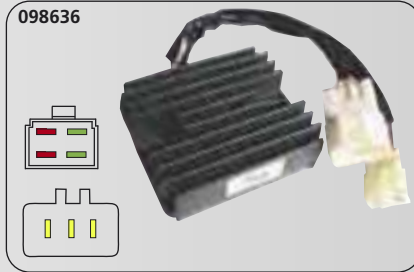
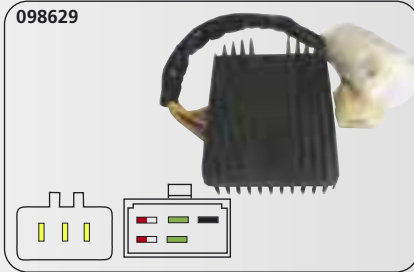
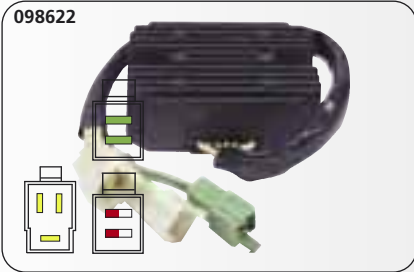
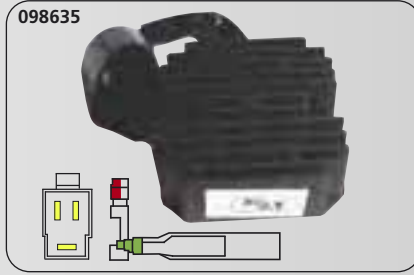
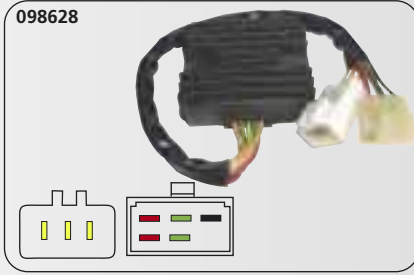
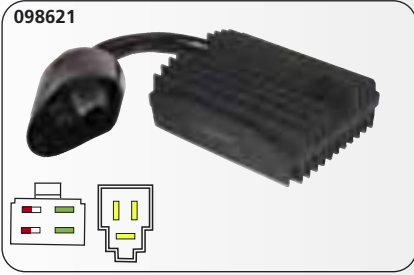

Stikord Sökord s. 2-5

Forhandlere Aterforsaljare s. 6-9

Toj/hjelme Kläder/hjälmar s. 11

Däck Däck s. 83

Olje Olja s. 115

Kæde/tandhjul Kedjor/drev s. 145

Bremser Broms s. 187

Låse Lås s. 347

Batteri Batterier s. 355

Pakninger Packningar s. 377

Motordele Motordelar s. 411

Lejer Lager s. 435

Karburator Förgasare s. 467

El-dele/ Tænding Elektriskt/ Tänding s. 509

Blinklygter Baglygter Belysning Baklygter s. 611

Lyddæmper Avgassystem s. 651

Støddæmper Støtdåmpere s. 681

Luft-/oliefilter Luft-/oljefilter s. 711

Kobling Koppling s. 769

Kabler Wire s. 803

Styr/greb Styre/handtag s. 829

Spejle og diverse Speglar och diverse s. 867

Bøger/værktøj Bøcker/verktyg s. 893

Ensretter/voltregulatorer
Likriktare/voltregulator



Mærke/ model	Type	Prod. årg.	Ensrettere/Regulator Varenr. OEM nr.	Ref.nr.		
Mærke/ modell	Typ	Prod. årg.	Likriktare/Regulator Art.nr. OEM. nr.	Ref.nr.	DKK	SEK
KAWASAKI						
GPZ 750 Unitrak	ZX750A	83-89	098707	21066-1038	RGU-408	1210,- 1513:-
GPZ 750 Turbo	ZX750E	84-85	098700	21066-1018	RGU-401	810,- 1013:-
GPX 750 F1-F4 Ninja		87-90	098951		ARC-901	1873,- 2341:-
GT 750 Kardan	KZ750P	82-85	098701	21066-1030	RGU-402	812,- 1015:-
H 2 750 MACH IV	H2	72-75	098701	21066-1030	RGU-402	812,- 1015:-
KZ 750 G1/M1 (2 cyl.)		80-82	098704		RGU-405	725,- 906:-
KZ 750 N1-N2		82-83	098701		RGU-402	812,- 1015:-
KVF 750		Fra 05	098713	21066-1127	RGU-417	659,- 824:-
VN 750 Vulcan	VN750A	86-93	098702	21066-1055/-1101	RGU-403	725,- 906:-
VN 750 Vulcan	VN750D	94-98	098703	21066-1089	RGU-404	812,- 1015:-
Z 750	ZR750J	Fra 04	098713	21066-1127	RGU-417	659,- 824:-
Z 750 B (2Zyl.)	KZ750B	76-78	098715	21066-029	RGU-410	706,- 883:-
Z 750 E	KZ750E	80-82	098705	21066-1008	RGU-406	1121,- 1401:-
Z 750 GT Kardan	KZ750P	82-85	098701	21066-1030	RGU-402	812,- 1015:-
Z 750 (L1/L2)	KZ750E	81-82	098705	21066-1008	RGU-406	1121,- 1401:-
Z 750 (L3/L4)	KZ750R	83-84	098701	21066-1030	RGU-402	812,- 1015:-
Z 750 LTD (4 cyl.)	KZ750H	80-82	098705	21066-1008	RGU-406	1121,- 1401:-
Z 750 LTD Belt Drive	KZ750Y/K	82-84	098704	21066-1014	RGU-405	725,- 906:-
ZR 7	ZR750F	Fra 99	098703	21066-1089	RGU-404	812,- 1015:-
ZR 7 S	ZR750H	Fra 01	098703	21066-1089	RGU-404	812,- 1015:-
ZR 750 Zephyr	ZR750C	91-93	098702	21066-1055/-1101	RGU-403	725,- 906:-
ZR 750 Zephyr	ZR750D	Fra 91	098703	21066-1089	RGU-404	812,- 1015:-
ZXR 750 R/RR		89-01	098951		ARC-901	1873,- 2341:-
VN 800 Classic	VN800B	Fra 96	098708	21066-1099	RGU-413	917,- 1146:-
VN 800 Drifter	VN800C/E	Fra 99	098708	21066-1099	RGU-413	917,- 1146:-
VN 800 Vulcan	VN800A	Fra 95	098708	21066-1099	RGU-413	917,- 1146:-
GPZ 900 A1-A3 Ninja		84-86	098951		ARC-901	1873,- 2341:-
GTR 1000 A1-A17		86-02	098951		ARC-901	1873,- 2341:-
VN 900 Classic		Fra 06	098713	21066-1127	RGU-417	659,- 824:-
Z 900/ Z1/ Z1A/ Z1B	Z1F	73-76	098700	21066-019	RGU-301	810,- 1013:-
ZL 900 A1/A2 Eliminator		85-86	098951		ARC-901	1873,- 2341:-
ZX-9R B1-B3		94-97	098951		ARC-901	1873,- 2341:-
ZX 9 R Ninja	ZX900C/D	98-99	098710	21066-1109	RGU-414	1210,- 1513:-
ZX 9 R Ninja	ZX900E/F	00-03	098714	21066-1119	RGU-420	1210,- 1513:-
Z 1000	ZR00A	Fra 03	098713	21066-1127	RGU-417	659,- 824:-
Z 1000 A1/A2	KZT00A1-2	77-78	098800	21066-019	RGU-301	1210,- 1513:-
Z 1000 MKII	KZT00A3-4	79-80	098705	21066-1008	RGU-406	1121,- 1401:-
Z 1000 H1 (Einspritzer)	KZT00H	80	098700	21066-1018	RGU-401	810,- 1013:-
Z 1000 J	KZT00J	81-82	098700	21066-1018	RGU-401	810,- 1013:-
Z 1000 LTD	KZT00B3-4	79-80	098705	21066-1008	RGU-406	1121,- 1401:-
Z 1000 LTD	KZT00K	81-83	098700	21066-1018	RGU-401	810,- 1013:-
Z 1000 Police	KZT00P	Fra 82	098700	21066-1018	RGU-401	810,- 1013:-
Z 1000 R1/R2	KZT00R	82-83	098700	21066-1018	RGU-401	810,- 1013:-
Z 1000 ST	KZT00E	79-80	098705	21066-1008	RGU-406	1121,- 1401:-
Z 1000 Z1R	KZT00D3	80	098705	21066-1008	RGU-406	1121,- 1401:-
Z 1000 A		03>	098713		RGU-417	659,- 824:-
ZL 1000 A1 Eliminator		87	098951		ARC-901	1873,- 2341:-
ZX 1000 A1/A2 Ninja		86-87	098951		ARC-901	1873,- 2341:-
ZX 10 R	ZXT10D	Fra 06	098713	21066-1127	RGU-417	659,- 824:-
GPZ 1100 Pre-Unitrak	KZT10B	81-82	098700	21066-1018	RGU-401	810,- 1013:-
GPZ 1100 Unitrak	ZXT10A	83-85	098700	21066-1018	RGU-401	810,- 1013:-
KZ 1100 D1-D2/L1/LTD		82-84	098700		RGU-401	810,- 1013:-
GPZ 1100 F1 (ABS)		96	098951		ARC-901	1873,- 2341:-
Z 1100 GP	KZT10B	81-82	098700	21066-1018	RGU-401	810,- 1013:-
Z 1100 ST	KZT10A	81-83	098700	21066-1018	RGU-401	810,- 1013:-
ZZR 1100 C1-C5/D4-D9		90-01	098951		ARC-901	1873,- 2341:-
ZRX 1200 R A1		01	098951		ARC-901	1873,- 2341:-
ZX 12 R	ZXT20A/B	00-03	098714	21066-1119	RGU-420	1210,- 1513:-
VN 1500 Vulcan/ SE	VNT50A1-5/B1-6	88-91	098702	21066-1055/-1101	RGU-403	725,- 906:-
VN 1500 Vulcan/ SE	VNT50A6-12/C1-4	92-98	098703	21066-1089	RGU-404	812,- 1015:-
SUZUKI						
GN 125	NF41A	Fra 94	098800	32800-49X50	RGU-301	1210,- 1513:-
GN 250	NJ42A	82-96	098800	32800-49X50	RGU-301	1210,- 1513:-
GSX 250	GS25X	80-81	098800	32800-49X50	RGU-301	1210,- 1513:-
GSX 250 E	GJ53B	82-83	098800	32800-49X50	RGU-301	1210,- 1513:-
GN 250		94>	098803		RGU-311	750,- 938:-
GZ 250 Marauder		99-09	098803		RGU-311	750,- 938:-
DR 350	DK41A	90-95	098804	32800-14D11	RGU-305	750,- 938:-
DR 350 S/ SE/ SH	SK42B	Fra 90	098804	32800-14D11	RGU-305	750,- 938:-
GN 400 /L /TD	GN400	80-83	098800	32800-49X50	RGU-301	1210,- 1513:-
GS 400 /E	GS400	77-83	098800	32800-49X50	RGU-301	1210,- 1513:-
GSX 400 E/ L/ S	GS40X	80-81	098800	32800-49X50	RGU-301	1210,- 1513:-
GSX 400 E/ S	GK53C	82-87	098800	32800-49X50	RGU-301	1210,- 1513:-

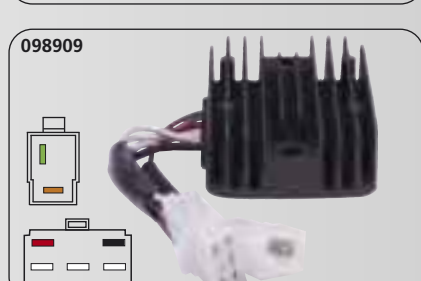
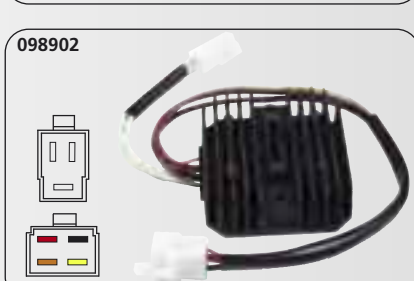
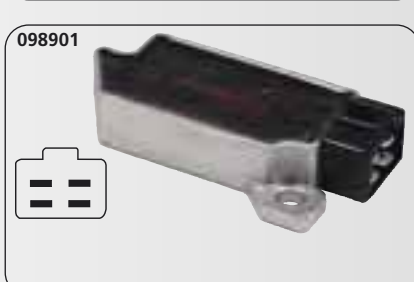
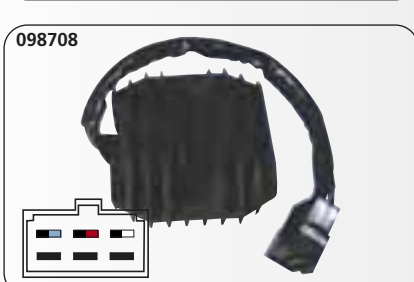
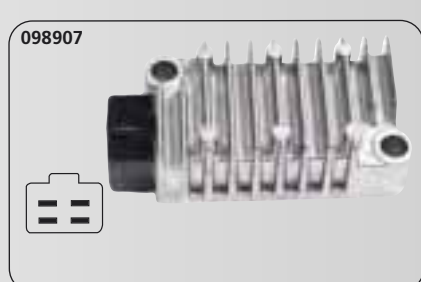
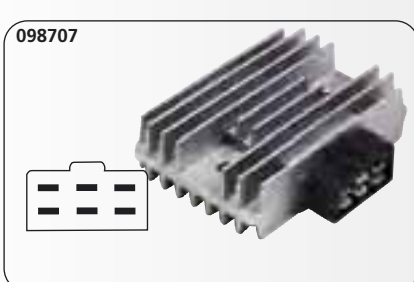
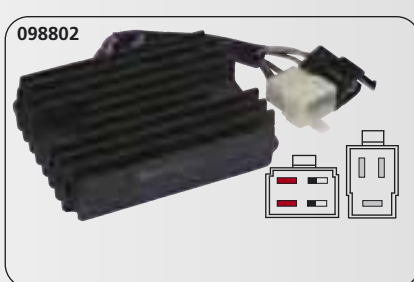
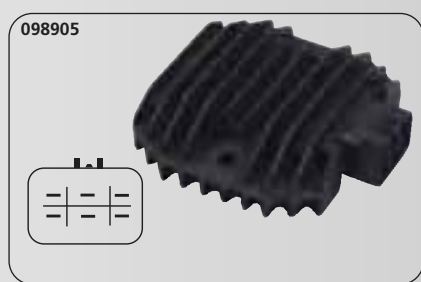
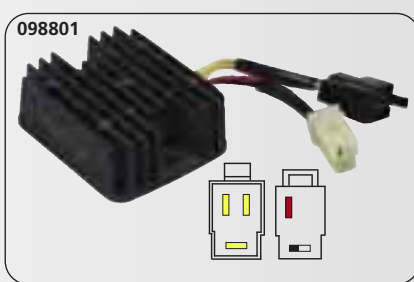
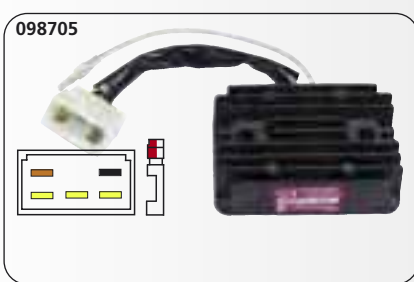
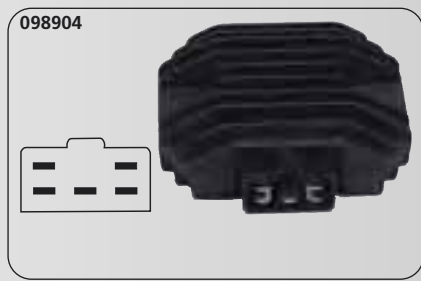
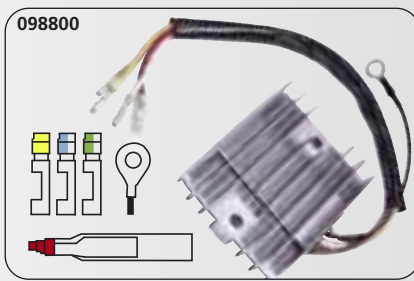
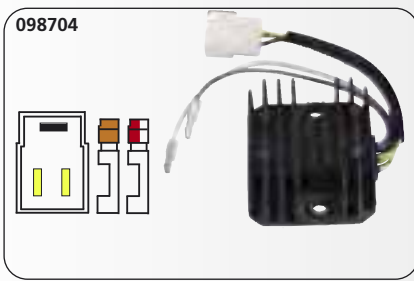
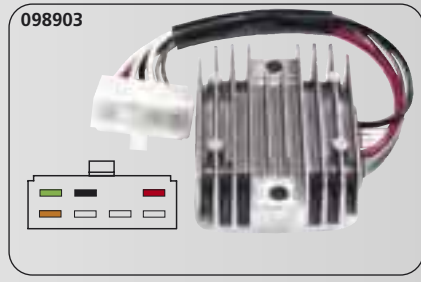
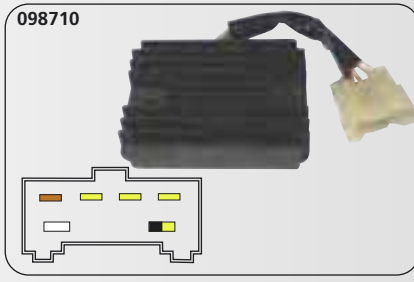
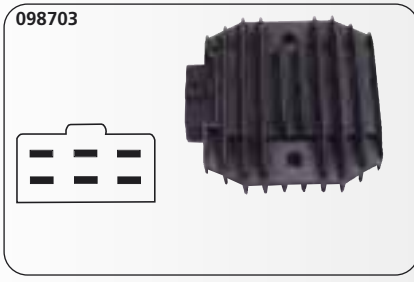

Stikord
Sökord
s. 2-5

Forhandlere
Aterforsaljare
s. 6-9

Toj/hjelme
Klader/
hjalmar
s. 11

Dæk
Dæk
s. 83

Olje
Olja
s. 115

Kæde/
tandhjul
Kedjor/
drev
s. 145

Bremser
Broms
s. 187

Låse
Lås
s. 347

Batteri
Batterier
s. 355

Pakninger
Packingar
s. 377

Motordele
Motordelar
s. 411

Lejer
Lager
s. 435

Karburator
Förgasare
s. 467

**El-dele/
Tænding
Elektrisk/
Tænding
s. 509**

Blinklygter
Baglygter
Belysning
Baklygter
s. 611

Lyddæmper
Avgassystem
s. 651

Støddæmper
Støtdæmpere
s. 681

Luft/
oliefilter
Luft/
oljefilter
s. 711

Kobling
Koppling
s. 769

Kabler
Wire
s. 803

Styr/greb
Styre/
handtag
s. 829

Spejle
og diverse
Speglar
och diverse
s. 867

Bøger/
værktøj
Böcker/
verktyg
s. 893

Ensretter/voltregulatorer
Likriktare/voltregulator



Mærke/ model	Type	Prod. årg.	Ensrettere/Regulator Varenr. OEM nr.	Ref.nr.	DKK	SEK
Märke/ modell	Typ	Prod. årg.	Likriktare/Regulator Art.nr. OEM. nr.	Ref.nr.	DKK	SEK
SUZUKI						
GSX 400 FE Katana	GS40XF	81-83	098800	32800-49X50	RGU-301	1210,- 1513:-
GS 425		78	098800		RGU-301	1210,- 1513:-
GS 450 E/L/S/T	GS450	80-83	098800	32800-49X50	RGU-301	1210,- 1513:-
GS 450 L	GL51D	85-87	098800	32800-49X50	RGU-301	1210,- 1513:-
GS 450 S/ SU/ E/ EU	GL51F	85-89	098800	32800-49X50	RGU-301	1210,- 1513:-
GS 550 /D	GS550	77-79	098800	32800-49X50	RGU-301	1210,- 1513:-
GS 550 E/L/T	GS550E	80-82	098800	32800-49X50	RGU-301	1210,- 1513:-
GS 550 M Katana	GS550M	81-83	098800	32800-49X50	RGU-301	1210,- 1513:-
DR 600 R/S	SN14A/AD	86-89	098800	32800-49X50	RGU-301	1210,- 1513:-
FR 600 RR/RS/RT		94-96	098951		ARC-901	1873,- 2341:-
GSF 600 ST/SV Bandit		96-97	098951		ARC-901	1873,- 2341:-
GSX 600 FJ/FK/FL/FM/FN Katana		88-92	098951		ARC-901	1873,- 2341:-
GSX 600 FP/FR/FS/FT/FV Katana		93-97	098951		ARC-901	1873,- 2341:-
GSX-R 600 WN/WP		92-93	098951		ARC-901	1873,- 2341:-
DR 650 R/RS	SP41/42/44B	90-94	098800	32800-49X50	RGU-301	1210,- 1513:-
DR 650 RE/RSE	SP43/45B	92-96	098800	32800-49X50	RGU-301	1210,- 1513:-
LS 650 Savage	NP41B	Fra 85	098801	32800-24B01	RGU-304	967,- 1209:-
SV 650 N/S	AV	99-02	098801	32800-24B01	RGU-304	967,- 1209:-
DR 750 S	SR41B	88-89	098800	32800-49X50	RGU-301	1210,- 1513:-
GS 750 D/E/L	GS750	77-79	098800	32800-49X50	RGU-301	1210,- 1513:-
GS 750 ET/EX/EZ		80-82	098800		RGU-301	1210,- 1513:-
GS 750 LN/LT/LX		79-81	098800		RGU-301	1210,- 1513:-
GSX 750 E/L	GS75X	80-82	098800	32800-49X50	RGU-301	1210,- 1513:-
GSX 750 ES/EF	GR72A	83-87	098800	32800-49X50	RGU-301	1210,- 1513:-
GSX 750 S Katana	GR71A	82-83	098800	32800-49X50	RGU-301	1210,- 1513:-
DR 800 S/ BIG	SR42/43B	Fra 90	098800	32800-49X50	RGU-301	1210,- 1513:-
GS 850 G/ GL	GS850/GS72A	79-86	098800	32800-49X50	RGU-301	1210,- 1513:-
RF 900 RR/RS/RT/RV/RZ S		94-99	098951		ARC-901	1873,- 2341:-
GS 1000 E/H/L/S	GS1000	78-80	098800	32800-49X50	RGU-301	1210,- 1513:-
GS 1000 G/ GL Kardan	GS100G	80-81	098800	32800-49X50	RGU-301	1210,- 1513:-
TL 1000 S/R	AG/AM	Fra 97	098802	32800-02F00	RGU-303	1210,- 1513:-
GS 1100 G Kardan	GU73A	84-86	098800	32800-49X50	RGU-301	1210,- 1513:-
GSX 1100 E/L	GS110X/GU71B	80-83	098800	32800-49X50	RGU-301	1210,- 1513:-
GSX 1100 SZ Katana	GS110XS	80-85	098800	32800-49X50	RGU-301	1210,- 1513:-
GSX 1100 ET/EX		80-81	098800		RGU-301	1210,- 1513:-
GSX 1100 FJ-FP Katana		88-93	098951		ARC-901	1873,- 2341:-
GSX 1100 GM/GN/GP Kardan		91-93	098951		ARC-901	1873,- 2341:-
GSX-R 1100 G-N/WP-WV		86-98	098951		ARC-901	1873,- 2341:-
GSF 1200 SV/SW/SX/SAV Bandit		97-99	098951		ARC-901	1873,- 2341:-
YAMAHA						
DT 125 R	DE031/032	99-03	098923	3LA-81960-01	RGU-230	385,- 481:-
TDR 125	4GW/5AN	Fra 93	098907	3TJ-81960-01	RGU-208	604,- 755:-
TW 125 Trailway	DE011/012	Fra 99	098907	3TJ-81960-01	RGU-208	604,- 755:-
TZR 125	4FL	97-98	098901	47X-81960-A1/A2/A3	RGU-202	636,- 795:-
XV 125 Virago	5AJ	97-02				
XVS 125 Dragstar	VE011/012	Fra 00	098905	5BN-81960-00	RGU-210	709,- 886:-
RD 250	1A2	78-79				
TZR/TDR 250	2MA/3CK	87-92	098901	47X-81960-A1/A2/A3	RGU-202	636,- 795:-
XV 250 Virago	3LS/3LW	88-98	098901	47X-81960-A1/A2/A3	RGU-202	636,- 795:-
XV 250		95>	098917		RGU-223	808,- 1010:-
XV 250 U/UC/W/WC/A/AC		88-91	098901		RGU-202	636,- 795:-
XVS 250 Drag Star	VG031	Fra 01	098905	5BN-81960-00	RGU-210	636,- 795:-
YP 250 Majesty	4UC/5DF	Fra 96	098904	4JH-81960-01	RGU-209	667,- 834:-
RD 350 LC YPVS	31K/31W/1WW	83-90	098901	47X-81960-A1/A2/A3	RGU-202	636,- 795:-
FZR 400	U/SUC/W/SWC/A/SAC	88>	098901		RGU-202	636,- 795:-
RD 400	1A3	78-79				
XS 400 DOHC	12E/12F	82-87	098903	12R/4H7-81960-A1/50	RGU-204	846,- 1058:-
RD 500 LC	47X/1GE	Fra 84	098901	47X-81960-A1/A2/A3	RGU-202	636,- 795:-
SR 500	2J4/48T	78-92				
XP 500 T-MAX		04-07	098916	5VX-81960-00	RGU-222	808,- 1010:-
XP 500 T-Max		01-03	098904		RGU-209	667,- 834:-
XV 500	26R	83-87	098902	4X7-81960-A0	RGU-203	798,- 998:-
XV 535 S/SE Virago	2YL/3BT/3BR	88-95	098900	42X-81960-A1	RGU-201	604,- 755:-
XV 535 S/SE Virago	4MC	96-03	098921	3JB-81960-01	RGU-228	794,- 993:-
XJ 550	4U8/4V8/27A	81-83	098910	3G1-81960-A1	RGU-216	1170,- 1463:-
XZ 550	11U/11V	82-84	098902	4X7-81960-A0	RGU-203	798,- 998:-
FJ 600 L/LC/N/NC		84-86	098903		RGU-204	846,- 1058:-
FZR 600	3HE/3RG/3RH	89-93	098901	47X-81960-A1/A2/A3	RGU-202	636,- 795:-
FZR 600 R	4JH/4MH	94-95	098904	4JH-81960-01	RGU-209	667,- 834:-
FZS 600 Fazer	RJ02/5DM	98-99	098917	3LS-81960-01	RGU-223	808,- 1010:-
FZS 600 Fazer	RJ02/5DM	02-03	098915	5RT-81960-00	RGU-221	808,- 1010:-
FZ 6 S		Fra 04	098918	5VX-81960-00	RGU-224	808,- 1010:-
FZ6		04-07	098916		RUG-222	808,- 1010:-

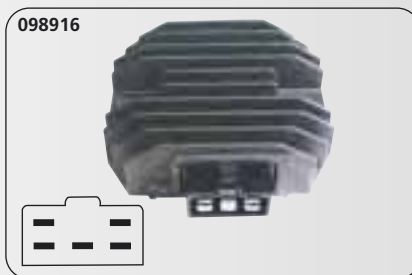
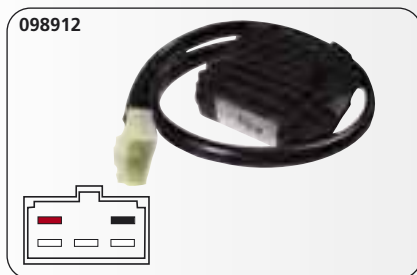
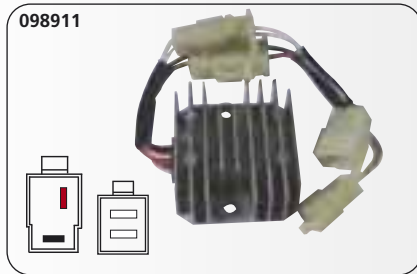
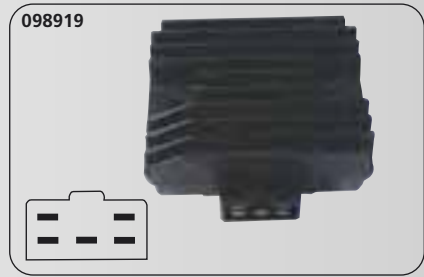
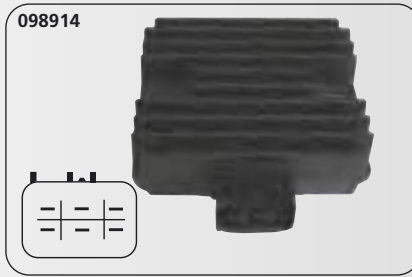
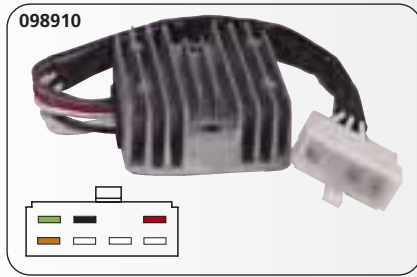

Märke/ modell	Type	Prod. årg.	Ensrettere/Regulator Varenr. OEM nr.	Ref.nr.		
Märke/ modell	Typ	Prod. årg.	Likriktare/Regulator Art.nr. OEM. nr.	Ref.nr.	DKK	SEK
YAMAHA						
FZ6 S2		07-08	098916	RUG-222	808,-	1010:-
FZ6 NS		05-06	098916	RUG-222	808,-	1010:-
XJ 6 N		09	098919	RGU-225	808,-	1010:-
FZ6 Fazer		03-07	098916	RUG-222	808,-	1010:-
FZ6 Fazer / S2		07-08	098916	RUG-222	808,-	1010:-
FZ6 Fazer ABS		06-08	098916	RUG-222	808,-	1010:-
TT 600 E/S	4GV/4LW	94-98	098901	47X-81960-A1/A2/A3	RGU-202	636,- 795:-
TT 600 R	5CH/DJ011	Fra 97	098907	3TJ-81960-01	RGU-208	604,- 755:-
XJ 600	51J	84-88	098903	12R/4H7-81960-A1/50	RGU-204	846,- 1058:-
XJ 600	3KM/3KN	89-91	098901	47X-81960-A1/A2/A3	RGU-202	636,- 795:-
XJ 600 N/S Diversion	4BR/4EB/4LX	92-97	098907	3TJ-81960-01	RGU-208	604,- 755:-
XJ 600 N/S Diversion		96-02	098926		RGU-213	530,- 663:-
XT 600	43F/49H/2KF	84-89	098911	34L-81960-A0	RGU-217	716,- 895:-
XT 600 E	3TB/3UW/4ME	90-95	098901	47X-81960-A1/A2/A3	RGU-202	636,- 795:-
XT 600 E	4PT	96-98	098907	3TJ-81960-01	RGU-208	604,- 755:-
XT 600 Z Tenere	34L/50T/55W	83-85	098911	34L-81960-A0	RGU-217	716,- 895:-
XT 600 Z Tenere	1VJ/3AJ	86-91	098901	47X-81960-A1/A2/A3	RGU-202	636,- 795:-
YZF - R6	5EB/RJ03	99-03	098904	4JH-81960-01	RGU-209	667,- 834:-
YZF - R6	5SL/RJ05	04-05	098919	5SL-81960-00	RGU-225	808,- 1010:-
YZF - R6		06	098914	4XY-81960-00	RGU-220	808,- 1010:-
YZF 600 R Thundercat	4TV/4WD	96-03	098904	4JH-81960-01	RGU-209	667,- 834:-
YZF 600 R/K/KC/R/MC Thunder.		98-02	098904		RGU-209	667,- 834:-
XJ 650 G/H/J/K/Maxim		80-83	098903		RGU-204	846,- 1058:-
XJ 650 RJ Seca		82	098903		RGU-204	846,- 1058:-
XJ 650 /Turbo	4K0/11T	80-84	098903	12R/4H7-81960-A1/50	RGU-204	846,- 1058:-
XS 650 SE	3L1/4G7/5E6	80-83	098910	3G1-81960-A1	RGU-216	1170,- 1463:-
XS 650 SJ/SK Heritage Special		82-83	098910		RGU-216	1170,- 1463:-
XV 650 AK/AKC/AL/ALC/AM/AMC		98-00	098905		RGU-210	709,- 886:-
XV 650 LC/MC		99-00	098905		RGU-210	709,- 886:-

- Stikord Sökord s. 2-5
- Forhandlere Aterforsäljare s. 6-9
- Töj/hjelme Kläder/hjälmnar s. 11
- Däck Däck s. 83
- Olie Olja s. 115
- Kæde/ tandhjul Kedjor/drev s. 145
- Bremser Broms s. 187
- Låse Lås s. 347
- Batteri Batterier s. 355
- Pakninger Packningar s. 377
- Motordele Motordelar s. 411
- Lejer Lager s. 435
- Karburator Förgasare s. 467
- El-dele/ Tænding Elektriskt/ Tænding s. 509
- Blinklygter Baglygter Belysning Baklygter s. 611
- Lyddæmper Avgassystem s. 651
- Støddæmper Støtdåmpare s. 681
- Luft-/ oliefilter Luft-/ oljefilter s. 711
- Kobling Koppling s. 769
- Kabler Wire s. 803
- Styr/greb Styre/håndtag s. 829
- Spejle og diverse Speglar och diverse s. 867
- Bøger/værktøj Bøcker/verktyg s. 893

Ensretter/voltregulatorer
Likriktare/voltregulator



Mærke/ model	Type	Prod. årg.	Ensrettere/Regulator Varenr. OEM nr.	Ref.nr.		
Mærke/ modell	Typ	Prod. årg.	Likriktare/Regulator Art.nr. OEM. nr.	Ref.nr.	DKK	SEK
YAMAHA						
XVS 650 Dragstar	4VR	Fra 97	098905	5BN-81960-00	RGU-210	709,- 886:-
XVS 650 Dragstar		97-99	098904		RGU-209	667,- 834:-
XVS 650 Dragstar		98-06	098913		RGU-219	919,- 1149:-
XVS 650 Dragstar Classic	VM02	98-00	098905	5BN-81960-00	RGU-210	709,- 886:-
XVS 650 Dragstar Classic	VM03	01-04	098912	5KP-81960-00	RGU-218	919,- 1149:-
MT-03 660		06	098914	4XY-81960-00	RGU-220	808,- 1010:-
SZR 660	4SU	Fra 96	098904	4JH-81960-01	RGU-209	667,- 834:-
XT 660		04-09	098919	5SL-81960-00	RGU-225	808,- 1010:-
XT 660 Z		94-96	098904		RGU-209	667,- 834:-
XTZ 660 Tenere	3YF/4MY/4MD	Fra 91	098901	47X-81960-A1/A2/A3	RGU-202	636,- 795:-
FZ 700 T/TC		87	098951		ARC-901	1873,- 2341:-
FZX 700 S/SC/T/TC		86-87	098951		ARC-901	1873,- 2341:-
XJ 700 Maxim		85-88	098903		RGU-204	846,- 1058:-
FZ 750 N/S/SC		85-86	098951		ARC-901	1873,- 2341:-
FZ 750 U/UC		88	098951		ARC-901	1873,- 2341:-
FZR 750 RT/RU		87	098951		ARC-901	1873,- 2341:-
XJ 750 J/K/MK Maxim		82-83	098903		RGU-204	846,- 1058:-
XJ 750 /SECA	41Y/11M	Fra 84	098903	12R/4H7-81960-A1/50	RGU-204	846,- 1058:-
XS 750 E/F		77-79	098909		RGU-215	1092,- 1365:-
XS 750 D/2D		77	098909		RGU-215	1092,- 1365:-
XS 750	1T5	77-79	098909	1T4-81960-A0	RGU-215	1092,- 1365:-
XS 750 SE/ U.S. Custom	3L3	80-82	098909	1T4-81960-A0	RGU-215	1092,- 1365:-
XTZ 750 Supertenere	3LD/3WM	89-97	098908	5A8-81960-A1	RGU-212	1030,- 1288:-
XV 750 SE Special	5G5/5K4	81-83	098902	4X7-81960-A0	RGU-203	798,- 998:-
XV 750 Virago	4FY/4PW	92-97	098900	42X-81960-A1	RGU-201	604,- 755:-
XV 750 SE/SF Special		78-79	098909		RGU-215	1092,- 1365:-
XV 750 SE Special		81-83	098902		RGU-203	798,- 998:-
XV 750 H/J/K Virago		81-83	098902		RGU-203	798,- 998:-
XV 750 MK/Midnight		83	098902		RGU-203	798,- 998:-
XV 750 V/VC/W/WC/A/AC/B/BC		88-91	098900		RGU-201	604,- 755:-
XV 750 Virage 4FY/4PW		92-97	098900		RGU-201	604,- 755:-
XV 750 J1/JC1/Virago		97	098906		RGU-211	818,- 1023:-
YZF 750 RF/RFC		94	098951		ARC-901	1873,- 2341:-
YZF 750 RH/RJ		96-97	098951		ARC-901	1873,- 2341:-
TDM 850	3VD/4CM	91-92	098907	3TJ-81960-01	RGU-208	604,- 755:-
TDM 850	4TX	96-01	098904	4JH-81960-01	RGU-209	667,- 834:-
TRX 850	4UN	Fra 96	098904	4JH-81960-01	RGU-209	667,- 834:-
XS 850	4E2	80-81	098909	1T4-81960-A0	RGU-215	1092,- 1365:-
XJ 900	31A/58L/4BB	83-94	098903	12R/4H7-81960-A1/50	RGU-204	846,- 1058:-
XV 920 SE Special	24N	81-83	098908	5A8-81960-A1	RGU-212	1030,- 1288:-
XV 920 J/K/MK/Virago		82-86	098902		RGU-203	798,- 998:-
FZR 1000		87-95	098951		ARC-901	1873,- 2341:-
FZS 1000 Fazer	RN06	01-05	098913	5FL-81960-00	RGU-219	919,- 1149:-
FZ 1000 Fazer		01-05	098912		RUG-218	919,- 1149:-
GTS 1000 AE/AF		93-94	098951		ARC-901	1873,- 2341:-
XV 1000/ TR1	5A8	81-82	098902	4X7-81960-A0	RGU-203	798,- 998:-
XV 1000 SE Special	19T/23W	82-85	098902	4X7-81960-A0	RGU-203	798,- 998:-
XV 1000 Virago	2AE/3DR	86-88	098900	42X-81960-A1	RGU-201	604,- 755:-
XV 1000 SH/SHC Virago		94-96	098900		RGU-201	604,- 755:-
YZF 1000 R Thunderace		96-01	098951		ARC-901	1873,- 2341:-
YZF 1000 R1	RN01/4XV	98-99	098904	4JH-81960-01	RGU-209	667,- 834:-
YZF 1000 R1	RN04/5JJ	00-01	098904	4JH-81960-01	RGU-209	667,- 834:-
YZF 1000 R1	RN12/5VY	04-05	098920	5VY-81960-00	RGU-226	1210,- 1513:-
YZF R1		04-05	098920		RGU-226	1210,- 1513:-
BT 1100 Bulldog	RP051	Fra 02	098905	5BN-81960-00	RGU-210	709,- 886:-
FJ 1100 L/LC/N/NC		84-85	098951		ARC-901	1873,- 2341:-
XS 1100 SF/SG/SH Special		79-81	098909		RGU-215	1092,- 1365:-
XS 1100/ XS 1100 S	2H9/5K7	78-82	098909	1T4-81960-A0	RGU-215	1092,- 1365:-
XV 1100 Virago	3LP	89-96	098900	42X-81960-A1	RGU-201	604,- 755:-
XV 1100 Virago	3LP	Fra 97	098906	3LP-81960-A1	RGU-211	818,- 1023:-
XV 1100 A/AC/B/BC/D/DC/E/EC		90-93	098900		RGU-201	604,- 755:-
XV 1100 F/FC/G/GC/H/HC		94-96	098900		RGU-201	604,- 755:-
XV 1100 SJ/SJC/SK/SKC		97-98	098906		RGU-211	818,- 1023:-
XVS 1100 Dragstar	VP05	99-02	098905	5BN-81960-00	RGU-210	709,- 886:-
XVS 1100 Dragstar	VP16	Fra 03	098914	4XY-81960-00	RGU-220	808,- 1010:-
FJ 1200 S		86-93	098951		ARC-901	1873,- 2341:-
V-Max 1200	1FK/2WE	85-95	098900	42X-81960-A1	RGU-201	604,- 755:-
V-Max 1200	2EN/VP031	96-02	098922	3JP-81960-01	RGU-227	1161,- 1451:-
XVZ 1300 A Royal Star	4YP	Fra 96	098917	3LS-81960-01	RGU-223	808,- 1010:-
XVZ 1300 AT Tour Class.	4NK/4NL	Fra 99	098914	4XY-81960-00	RGU-220	808,- 1010:-
XVZ 1300 Royal Star Vent.	5JC	Fra 99	098914	4XY-81960-00	RGU-220	808,- 1010:-
XVZ 13 Venture / Royal Star		00-04	098914		RGU-220	808,- 1010:-
XV 1600 Wild Star	5JA/VP081	Fra 99	098905	5BN-81960-00	RGU-210	709,- 886:-

Spændingsregulatorer

Nye regulatorer, med samme specifikationer som de originale. Fremstillet på samme fabrik i Japan. Alle stik passer på det originale ledningsnet. High quality - Made in Japan.

Spänningsregulatorer

Nya regulatorer med samma specifikationer som originalet eftersom de är utvecklade på samma japanska fabrik. Alla kontakter/stik passar på motorcykelns originalkablar.

Mærke/ model	Prod. årg.	Spændingsregulator Varenr.	Ref.nr.		
Mærke/ modell	Prod. årg.	Spännings Art.nr.	Regulator Ref.nr.	DKK	SEK
KAWASAKI					
GPX 750 F1-F4 Ninja	87-90	098950	ARE-901	2031,-	2539,-
ZXR 750 R/RR	89-01	098950	ARE-901	2031,-	2539,-
GPZ 900 A1-A3 Ninja	84-86	098950	ARE-901	2031,-	2539,-
L 900 A1/A2 Eliminator	85-86	098950	ARE-901	2031,-	2539,-
ZX-9R B1-B3	94-97	098950	ARE-901	2031,-	2539,-
GTR 1000 A1-A17	86-02	098950	ARE-901	2031,-	2539,-
L 1000 A1 Eliminator	87	098950	ARE-901	2031,-	2539,-
ZX 1000 A1/A2 Ninja	86-87	098950	ARE-901	2031,-	2539,-
ZX-10 B1/B2/B3	88-91	098950	ARE-901	2031,-	2539,-
GPZ 1100 E1-E3	95-97	098950	ARE-901	2031,-	2539,-
GPZ 1100 F1 (ABS)	96	098950	ARE-901	2031,-	2539,-
ZZR 1100 C1-C5/D4-D9	90-01	098950	ARE-901	2031,-	2539,-
ZRX 1200 R A1	01	098950	ARE-901	2031,-	2539,-
SUZUKI					
R 600 RR/RS/RT	94-96	098950	ARE-901	2031,-	2539,-
GSF 600 ST/SV Bandit	96-97	098950	ARE-901	2031,-	2539,-
GSX 600 FJ/FK/FL/FM/FN Katana	88-92	098950	ARE-901	2031,-	2539,-
GSX 600 FP/FR/FS/FT/FV Katana	93-97	098950	ARE-901	2031,-	2539,-
GSX-R 600 WN/WP	92-93	098950	ARE-901	2031,-	2539,-
GSX 750 FK-FN/FR-FT Katana	89-96	098950	ARE-901	2031,-	2539,-
GSX 750 RG G-N/WP-WS	86-95	098950	ARE-901	2031,-	2539,-
RF 900 RR/RS/RT/RV/RZ S	94-99	098950	ARE-901	2031,-	2539,-
GSX 1100 FJ-FP Katana	88-93	098950	ARE-901	2031,-	2539,-
GSX 1100 GM/GN/GP Kardan	91-93	098950	ARE-901	2031,-	2539,-
GSX-R 1100 G-N/WP-WV	86-98	098950	ARE-901	2031,-	2539,-
GSF 1200 SV/SW/SX/SAV Bandit	97-99	098950	ARE-901	2031,-	2539,-
YAMAHA					
FZ 700 T/TC	87	098950	ARE-901	2031,-	2539,-
FZX 700 S/SC/T/TC	86-87	098950	ARE-901	2031,-	2539,-
FZ 750 N/S/SC	85-86	098950	ARE-901	2031,-	2539,-
FZ 750 U/UC	88	098950	ARE-901	2031,-	2539,-
FZR 750 RT/RU	87	098950	ARE-901	2031,-	2539,-
YZF 750 RF/RFC	94	098950	ARE-901	2031,-	2539,-
YZF 750 RH/RJ	96-97	098950	ARE-901	2031,-	2539,-
FZR 1000	87-95	098950	ARE-901	2031,-	2539,-
GTS 1000 AE/AF	93-94	098950	ARE-901	2031,-	2539,-
YZF 1000 R Thunderace	96-01	098950	ARE-901	2031,-	2539,-
FJ 1100 L/LC/N/NC	84-85	098950	ARE-901	2031,-	2539,-
FJ 1200 S	86-93	098950	ARE-901	2031,-	2539,-



098950



Stikord
Søikord
s. 2-5

Forhandlere
Aterforsäljare
s. 6-9

Tøj/hjelme
Klæder/
hjelmar
s. 11

Dæk
Dækk
s. 83

Olie
Olja
s. 115

Kæde/
tandhjul
Kedjor/
drev
s. 145

Bremser
Broms
s. 187

Låse
Lås
s. 347

Batteri
Batterier
s. 355

Pakninger
Packingar
s. 377

Motordele
Motordelar
s. 411

Lejer
Lager
s. 435

Karburator
Förgasare
s. 467

El-dele/
Tænding
Elektrisk/
Tænding
s. 509

Blinklygter
Baglygter
Belysning
Baklygter
s. 611

Lyddæmper
Avgassystem
s. 651

Støddæmper
Støtdämpare
s. 681

Luft/
oliefilter
Luft/
oljefilter
s. 711

Kobling
Koppling
s. 769

Kabler
Wire
s. 803

Styr/greb
Styre/
handtag
s. 829

Spejle
og diverse
Speglar
och diverse
s. 867

Bøger/
værktøj
Böcker/
verktyg
s. 893

Ensretter/voltregulatorer/Spændingsregulatorer

Til visse modeller er ensretter og voltregulator to enheder.
 Alle ensrettere med voltregulator har ref.nr. RR. Alle separate regulatorer har ref.nr. RG.
 Du kan finde et foto af alle forskellige enheder. Alle enheder er fremstillet i Europa, undtagen
 vare nr. 098400, der er fremstillet i Japan.

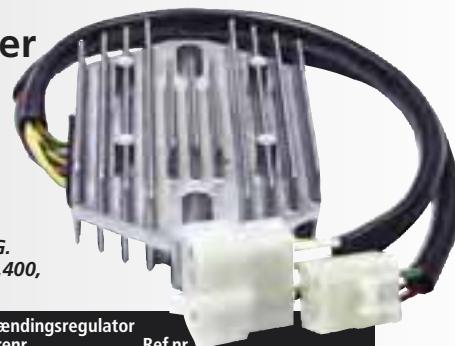

Likriktare/voltregulator/Spänningsregulator

Vissa modeller är likriktare och spänningsregulator två enheter.
 Alla likriktare med voltregulator har referens RR. Alla separata spänningsregulatorer har ref. nr. RG.
 Du kan hitta ett foto av alla de olika enheterna. Alla enheter tillverkas i Europa, utom Part No 098.400,
 den är tillverkad i Japan.

Mærke/ model	Prod. årg.	Ensrettere/Regulator Varenr.	Ref.nr.		Spændingsregulator Varenr.	Ref.nr.		
Mærke/ modell	Prod. årg.	Likriktare/Regulator Art.nr.	Ref.nr.	DKK	SEK	Spänningsregulator Art.nr.	Ref.nr.	DKK SEK
AJS								
Alle (Lucas nr. 49072)	63>	098400	LRC001	396,-	495,-			
APRILIA								
RS 125	02-04	098505	RR812	1653,-	2066,-			
RS 250	02-04	098505	RR812	1653,-	2066,-			
650 Pegaso	94-95	098201	RR10	981,-	1226,-			
650 Pegaso	96->	098503	RR71	1199,-	1499,-			
RSV 1000 Mille	98-05	098004	RR58	1287,-	1609,-			
RST 1000 Futura	01-05	098004	RR58	1287,-	1609,-			
SL 1000 Falco	00>	098004	RR58	1287,-	1609,-			
1000 Caponord	04-06	098004	RR58	1287,-	1609,-			
ARIEL								
Alle (Lucas nr. 49072)	59>	098400	LRC001	396,-	495,-			
BMW								
R50/5-R60/5-R60/6		098500	RR45	1199,-	1499,-			
R60/7	>85	098500	RR45	1199,-	1499,-			
R75/5-R75/6		098500	RR45	1199,-	1499,-			
R80 GS	88	098500	RR45	1199,-	1499,-			
R80/6-R80/7	>85	098500	RR45	1199,-	1499,-			
R90/5-R90/6		098500	RR45	1199,-	1499,-			
R 100 CS	85	098500	RR45	1199,-	1499,-			
R 100 GS	94	098500	RR45	1199,-	1499,-			
R 100RS/RT/5/T/7	85	098500	RR45	1199,-	1499,-			
F 650		098503	RR71	1199,-	1499,-			
BSA								
Alle (Lucas nr. 49072)	59>	098400	LRC001	396,-	495,-			
CAGIVA								
750 Elefant		098501	RR51	1287,-	1609,-			
900 Elefant		098501	RR51	1287,-	1609,-			
DUCATI								
350 SS		098501	RR51	1287,-	1609,-			
400 SS	91-93	098501	RR51	1287,-	1609,-			
500 Pantah	80	098501	RR51	1287,-	1609,-			
600 SS/Monster	94-96	098501	RR51	1287,-	1609,-			
620 Multistrada	05-06	098020	RR53	2071,-	2589,-			
620 Sport	03-05	098020	RR53	2071,-	2589,-			
748	95	098501	RR51	1287,-	1609,-			
750 F1/Paso	86	098501	RR51	1287,-	1609,-			
750 Sport	74-76	098501	RR51	1287,-	1609,-			
750 SS/Monster	94->	098501	RR51	1287,-	1609,-			
800 Supersport/Monster	03-05	098020	RR53	2071,-	2589,-			
851	89	098501	RR51	1287,-	1609,-			
888 Strada	93	098501	RR51	1287,-	1609,-			
900 Darmah		098501	RR51	1287,-	1609,-			
900 Monster	94>	098501	RR51	1287,-	1609,-			
900 SS	78	098501	RR51	1287,-	1609,-			
907 IE	92	098501	RR51	1287,-	1609,-			
916 Strada		098501	RR51	1287,-	1609,-			
ST3/ST4/ST4S	98-05	098020	RR53	2071,-	2589,-			
996	99->	098020	RR53	2071,-	2589,-			
998/999	03-05	098020	RR53	2071,-	2589,-			
1000 DS Monster/Multistrada/SS	05	098020	RR53	2071,-	2589,-			
HARLEY DAVIDSON								
1340 Dyna		098502	RR80	969,-	1211,-			
1340 FXR		098502	RR80	969,-	1211,-			
1340 Softtail		098502	RR80	969,-	1211,-			
HONDA								
CB1-400	89-90	098004	RR58	1287,-	1609,-			
MTX 125	83	098009	RR67	946,-	1183,-			
XL 125	77-78	098009	RR67	946,-	1183,-			
CB 250 C Custom	82-83	098003	RR18	1069,-	1336,-			
CB 250 N/T	77->	098003	RR18	1069,-	1336,-			
CB 250 N	79-83	098003	RR18	1069,-	1336,-			

* Der kan være tale om to typer ! - Se venligst illustrations-tegning./Jämför med bilden, det finns flera typer av just denna.

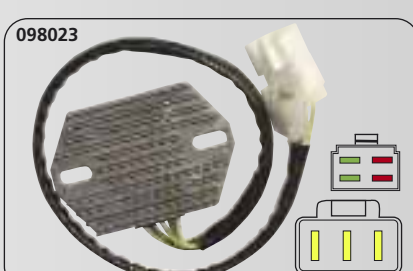
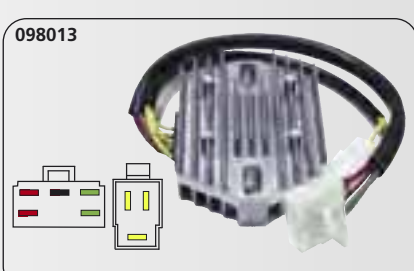
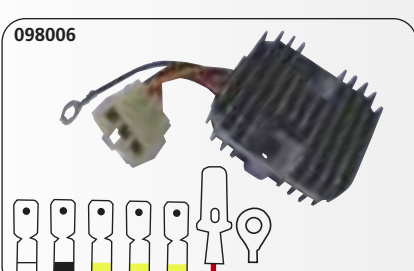
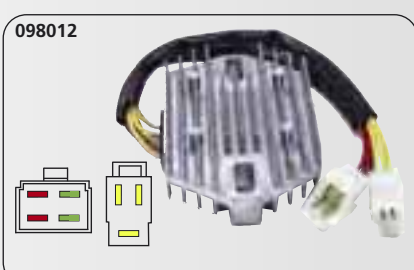
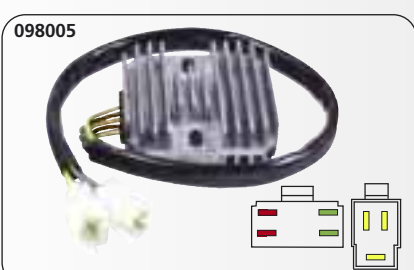
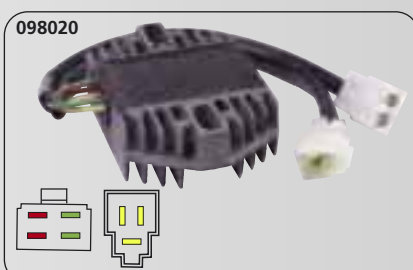
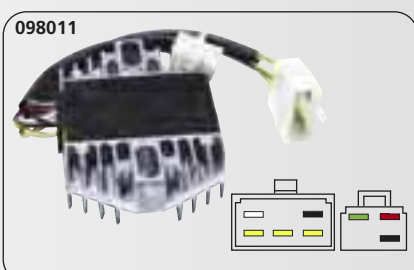
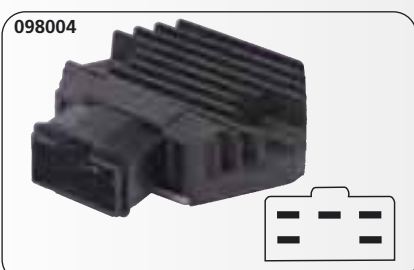
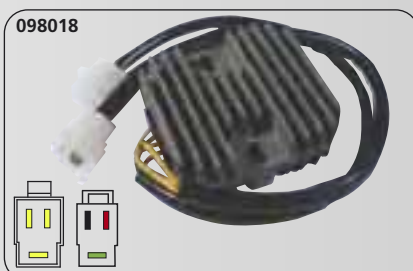
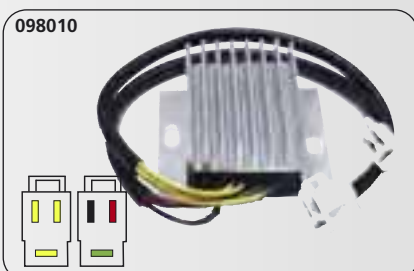
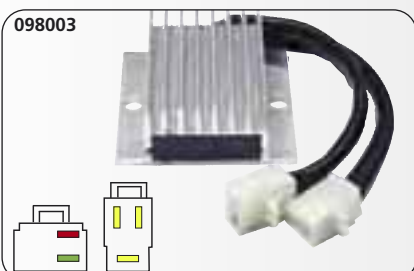
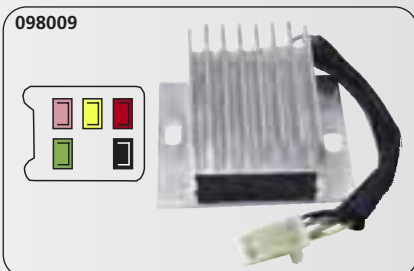
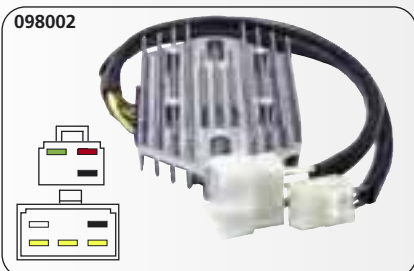
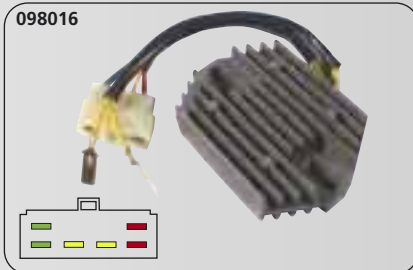
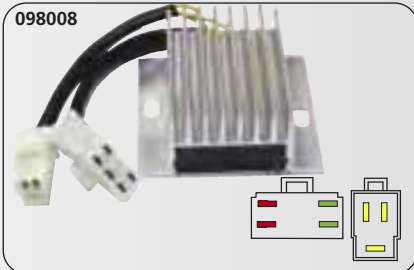
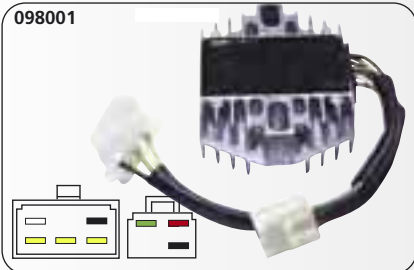
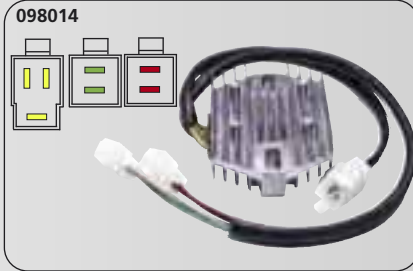
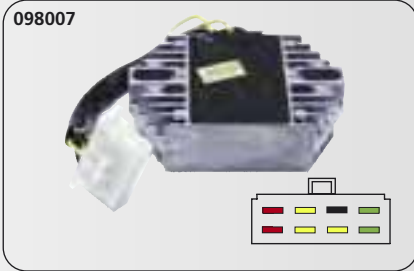
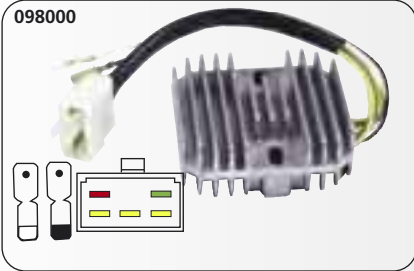

* Der kan være tale om to typer ! - Se venligst illustrations-tegning./Jämför med bilden, det finns flera typer av just denna.

- Stikord Sökord s. 2-5
- Forhandlere Aterforsaljare s. 6-9
- Tøj/hjelme Klæder/hjælmar s. 11
- Dæk Däck s. 83
- Olie Olja s. 115
- Kæde/tandhjul Kedjor/drev s. 145
- Bremser Brems s. 187
- Låse Lås s. 347
- Batteri Batterier s. 355
- Pakninger Pakningar s. 377
- Motordele Motordelar s. 411
- Lejer Lager s. 435
- Karburator Förgasare s. 467
- El-dele/ Tænding Elektriskt/Tænding s. 509**
- Blinklygter Baglygter Belysning Baklygter s. 611
- Lyddæmper Avgassystem s. 651
- Støddæmper Støtdæmpere s. 681
- Luft-/oliefilter Luft-/oljefilter s. 711
- Kobling Koppling s. 769
- Kabler Wire s. 803
- Styr/greb Styre/handtag s. 829
- Spejle og diverse Speglar och diverse s. 867
- Bøger/værktøj Bøger/verktøy s. 893

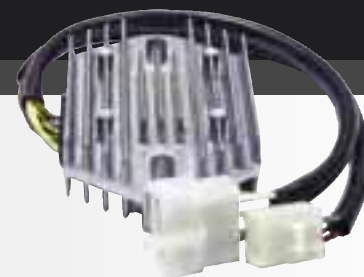

Ensretter/voltregulatorer/Spændingsregulatorer

Fremstillet i Europa

Likriktare/voltregulator/Spänningsregulator

Tillverkade i Europa

Mærke/ model	Prod. årg.	Ensrettere/Regulator Varenr.	Ref.nr.	DKK	SEK	Spændingsregulator Varenr.	Ref.nr.	DKK	SEK
Mærke/ modell	Prod. årg.	Likriktare/Regulator Art.nr.	Ref.nr.	DKK	SEK	Spänningsregulator Art.nr.	Ref.nr.	DKK	SEK
HONDA									
CB 250 RS	80-84	098003	RR18	1069,-	1336:-				
CB 250 RS (el-start)	77->	098003	RR18	1069,-	1336:-				
CB 250 RS (kick-start)		098003	RR18	1069,-	1336:-				
CB 250 T	92	098003	RR18	1069,-	1336:-				
XL 250 R/RFVC	83-87	098009	RR67	946,-	1183:-	098021	RG12	262,-	328:-
XL 250 S	78-81	098009	RR67	946,-	1183:-				
NX 250	88->	098004	RR58	1287,-	1609:-				
CMX 250 Rebel	96->	098027	RR79	969,-	1211:-				
CB 350 (2 cyl.)	72-76	098010	RR16	1069,-	1336:-				
CB 350 F	73-76	098000	RR24	981,-	1226:-				
XL 350 R	84-87	098009	RR67	946,-	1183:-	098021	RG12	262,-	328:-
CB 400 F	75-79	098000	RR24	981,-	1226:-				
CB 400 N	79-84	098003	RR18	1069,-	1336:-				
CB 400 T	78	098003	RR18	1069,-	1336:-				
CBR 400 R (NC29)	85-87	098208	RR17	1042,-	1303:-				
CBR 400 RR (NC-23)	88	098004	RR58	1287,-	1609:-				
CBX 400 F	82-85	098001	RR19	1069,-	1336:-				
VF 400 F	85	098008	RR65	1199,-	1499:-				
VFR 400 (NC-24)	86	098005*	RR63	1161,-	1451:-				
VFR 400 (NC-30)	87	098004	RR58	1287,-	1609:-				
VFR 400 R (NC-21)	86	098005*	RR63	1161,-	1451:-				
CB 450 K1-K5	69-75	098010	RR16	1069,-	1336:-				
CB 450 N/DX/S	84->	098003	RR18	1069,-	1336:-				
CMX 450 Rebel	85-87	098003	RR18	1069,-	1336:-				
CB 450 S	86-89	098003	RR18	1069,-	1336:-				
CB 500 F	71-77	098000	RR24	981,-	1226:-				
CB 500 R	94-97	098004	RR58	1069,-	1609:-				
CX 500 FRA	79-81	098003	RR18	1069,-	1336:-				
CX 500 /C	78-84	098010	RR16	1069,-	1336:-				
CX 500 E Prolink	82-84	098008	RR65	1199,-	1499:-				
CX 500 T Turbo	82-83	098008	RR65	1199,-	1499:-				
GL 500	81-82	098008	RR65	1199,-	1499:-				
VF 500 V30 Magna	84-85	098008	RR65	1199,-	1499:-				
VF 500 F/F2	84-86	098008	RR65	1199,-	1499:-				
VT 500 C Shadow	83-86	098012	RR25	1050,-	1313:-				
VT 500 E/FT	83-84	098008	RR65	1199,-	1499:-				
XL 500 R/S	79-82	098009	RR67	946,-	1183:-				
XR 500 R	83-97					098021	RG12	262,-	328:-
CB 550 F/K3	73-77	098000	RR24	981,-	1226:-				
CBX 550 F/F2	82-86	098011	RR22	1042,-	1303:-				
CBR 600 F/F2/F3	87-00	098004	RR58	1287,-	1609:-				
CBR 600 F4	91->	098023	RR43	1827,-	2284:-				
CBR 600 RR	01->	098025	RR69	1786,-	2233:-				
CBR 600	03-04	098028	RR89	1827,-	2284:-				
CBR 600 F/F2	89-00	098004	RR58	1287,-	1609:-				
CBR 600 FJ	88	098210	RR62	1417,-	1771:-				
CBR 600 RR	03->	098023	RR43	1827,-	2284:-				
VT 600 C Shadow	88-98	098012	RR25	1050,-	1313:-				
XL 600 R	83-87					098021	RG12	262,-	328:-
XL 600 V Transalp	87	098013	RR64	1199,-	1499:-				
XR 600 R	83-97	098009	RR67	946,-	1183:-	098021	RG12	262,-	328:-
CB 650 C/Z	78-80	098001	RR19	1069,-	1336:-				
CB 650 SC Nighthawk	82-86	098200	RR19	964,-	1205:-				
CX 650 E/C/Turbo	82-83	098008	RR65	1199,-	1499:-				
GL 650	82	098008	RR65	1199,-	1499:-				
NTV 650 Révére	88-93	098012	RR25	1050,-	1313:-				
NV 650 C	83	098008	RR65	1199,-	1499:-				
NT 650 GT Nighthawk	88-91	098012	RR25	1050,-	1313:-				
NTV 650 Deauville		098004	RR58	1287,-	1609:-				
NTV 650 Revere	88-93	098012	RR25	1050,-	1313:-				
NX 650 Dominator	88-95	098018	RR66	1047,-	1309:-				
XL 650 V		098004	RR58	1287,-	1609:-				
XRV 650	88-89	098110	RR84	1653,-	2066:-				
VT 700 C Shadow	83-84	098014	RR12	1170,-	1463:-				
VF 700 S V45 Magna	84-87	098008	RR65	1199,-	1499:-				
CB 750 F/F2	77-79	098000	RR24	981,-	1226:-				
CB 750 F2	85-96	098006	RR23	1287,-	1609:-				
CB 750 K1-K7	69-78	098000	RR24	981,-	1226:-				
CB 750 C	80-82	098002	RR21	1030,-	1288:-				
CB 750 KZ	79-83	098002	RR21	1030,-	1288:-				
CB 750 C/F/KZ (Dohc)	80-82	098002	RR21	1030,-	1288:-				
CB 750 FA/FB	80-82	098002	RR21	1030,-	1288:-				

* Der kan være tale om to typer ! - Se venligst illustrations-tegning./Jämför med bilden, det finns flera typer av just denna.

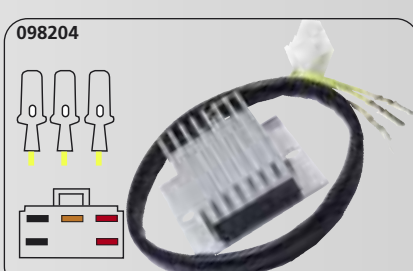
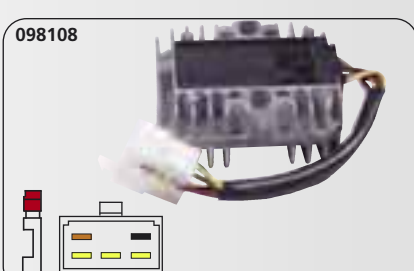
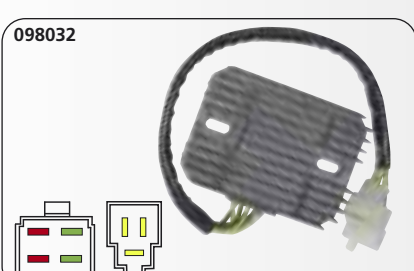
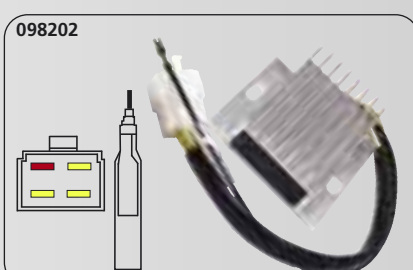
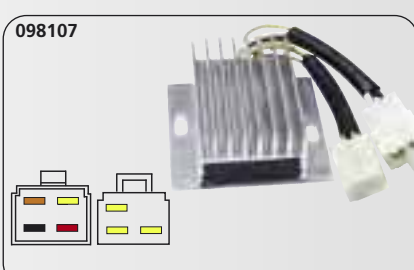
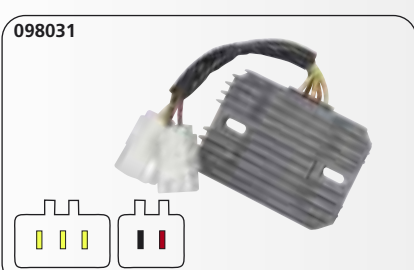
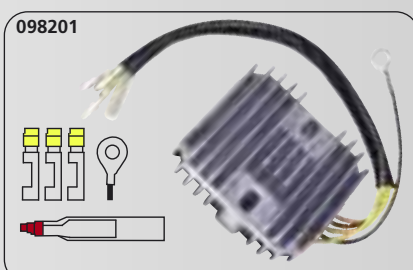
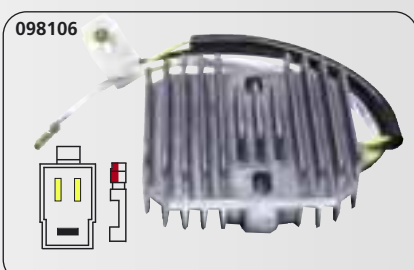
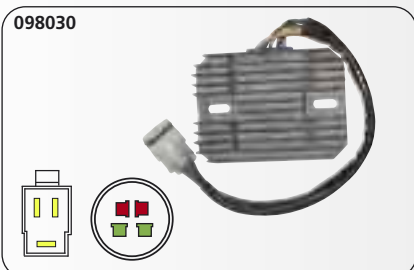
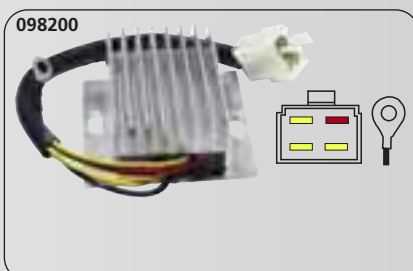
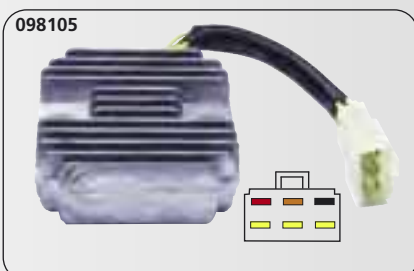
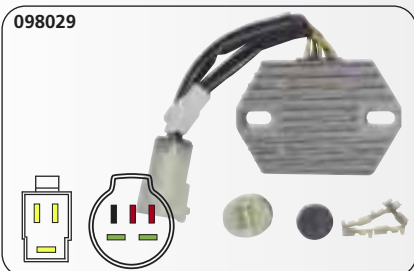
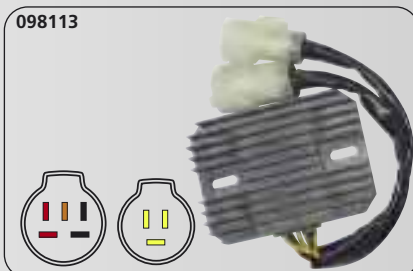
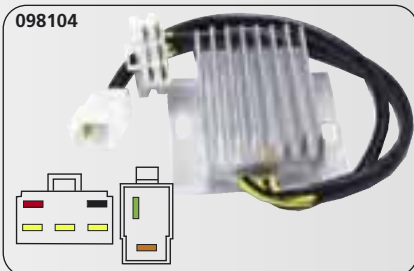
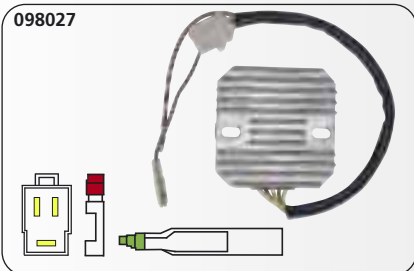
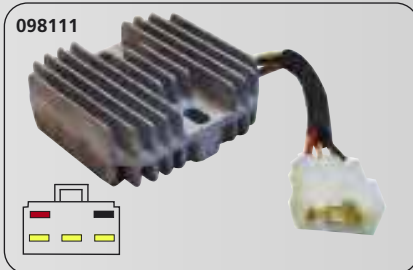
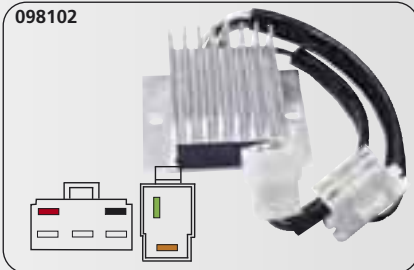
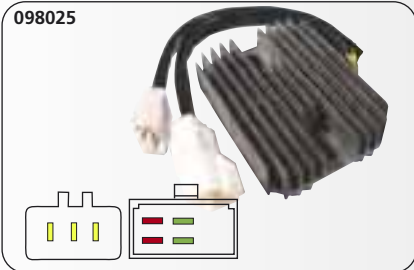
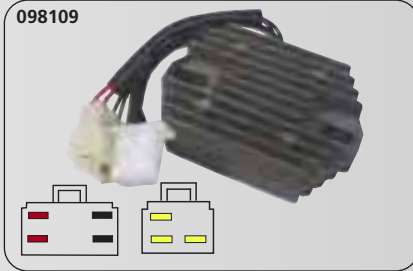
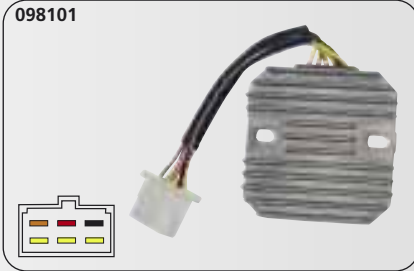
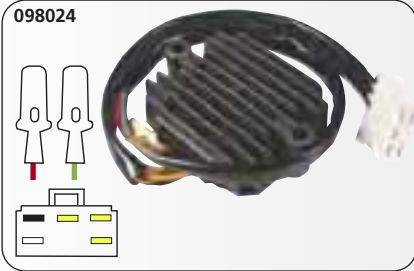

- Stikord Sökord s. 2-5
- Forhandlere Aterforsäljare s. 6-9
- Tøj/hjelme Kläder/hjälmnar s. 11
- Dæk Däck s. 83
- Olie Olja s. 115
- Kæde/ tandhjul Kedjor/ drev s. 145
- Bremser Broms s. 187
- Låse Lås s. 347
- Batteri Batterier s. 355
- Pakninger Packningar s. 377
- Motordele Motordelar s. 411
- Lejer Lager s. 435
- Karburator Förgasare s. 467
- El-dele/ Tænding Elektriskt/ Tänding s. 509**
- Blinklygter Baglygter Belysning Baklygter s. 611
- Lyddæmper Avgassystem s. 651
- Støddæmper Støtdåmpare s. 681
- Luft-/ oliefilter Luft-/ oljefilter s. 711
- Kobling Koppling s. 769
- Kabler Wire s. 803
- Styr/greb Styre/ handtag s. 829
- Spejle og diverse Speglar och diverse s. 867
- Bøjer/ værktøj Bøjler/ værktøj s. 893

* Der kan være tale om to typer ! - Se venligst illustrations-tegning./Jämför med bilden, det finns flera typer av just denna.

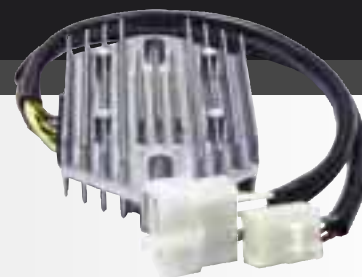

Ensretter/voltregulatorer/Spændingsregulatorer

Fremstillet i Europa

Likriktare/voltregulator/Spänningsregulator

Tillverkade i Europa

Mærke/ model	Prod. årg.	Ensrettere/Regulator Varenr.	Ref.nr.	DKK	SEK	Spændingsregulator Varenr.	Ref.nr.	DKK	SEK
Märke/ modell	Prod. årg.	Likriktare/Regulator Art.nr.	Ref.nr.	DKK	SEK	Spänningsregulator Art.nr.	Ref.nr.	DKK	SEK
HONDA									
CB 750 Seven Fifty	91-01	098006	RR23	1287,-	1609,-				
CBX 750 F/F2	83-94	098001	RR19	1069,-	1336,-				
CB 750 F2 (Dohc)	77-79	098002	RR21	1030,-	1288,-				
RVF 750 R	94-96	098004	RR58	1287,-	1609,-				
VF 750 F	83-85	098008	RR65	1199,-	1499,-				
VF 750 S	82-85	098008	RR65	1199,-	1499,-				
VF 750 V45 Magna	82-98	098008	RR65	1199,-	1499,-				
VFR 750 F G/H	88-89	098210	RR62	1417,-	1771,-				
VFR 750 F J/K	90-91	098210	RR62	1417,-	1771,-				
VFR 750 F L	92>	098004	RR58	1287,-	1609,-				
VT 750 C Shadow	83-87	098014*/098008*	RR12/RR65	1170,-	1463,-				
XRV 750 Africa Twin	89-90	098013	RR64	1199,-	1499,-				
XRV 750 Africa Twin	90-93	098029	RR82	1786,-	2233,-				
XRV 750 Africa Twin	94-00	098030	RR83	1653,-	2066,-				
PC 800 Pacific Coast	89-97	098004	RR58	1287,-	1609,-				
VFR 800	98-00	098020	RR53	2071,-	2589,-				
VFR 800 VTEC	00->	098025	RR69	1786,-	2233,-				
VT 800 C Shadow	88	098008	RR65	1199,-	1499,-				
CB 900 F/F2	79-83	098002	RR21	1030,-	1288,-				
CBR 900 RR Fireblade	92-99	098004	RR58	1287,-	1609,-				
CBR 900 Fireblade	00->	098020	RR43	2071,-	2589,-				
CBR 1000	87-90	098024	RR87	1417,-	1771,-				
CBR 1000 F	90-96	098006	RR23	1287,-	1609,-				
CBX 1000/ProLink	78-81	098011	RR22	1042,-	1303,-				
GL 1000	75->	098007	RR29	1260,-	1575,-				
VF 1000 F/F2/R	84-86	098008	RR65	1199,-	1499,-				
VTR 1000 Firestorm	97>	098004	RR58	1287,-	1609,-				
VTR 1000 SP1		098020	RR43	2071,-	2589,-				
CBR 1000 RR	04->	098031	RR110	1827,-	2284,-				
XL 1000 Varadero	99	098004	RR58	1287,-	1609,-				
CB 1100 F/R	83	098002	RR21	1030,-	1288,-				
CB 1100 F/R	81-83	098011	RR22	1042,-	1303,-				
CBR 1100 XX Blackbird	96-98	098004	RR58	1287,-	1609,-				
CBR 1100 XX Blackbird i.e.	99>	098025	RR69	1786,-	2233,-				
GL 1100	80-83	098007	RR29	1260,-	1575,-				
ST 1100 Pan European	90	098006	RR23	1287,-	1609,-				
VF 1100 F2/C	83-86	098008	RR65	1199,-	1499,-				
VT 1100 C Shadow	85-94	098014	RR12	1170,-	1463,-				
VT 1100 Shadow	02->	098026	RR81	1653,-	2066,-				
GL 1200	84-88	098007	RR29	1260,-	1575,-				
GL 1200 SEI Injection		098016	RR57	1222,-	1528,-				
CB 1300		098032	RR113	1827,-	2284,-				
VTX 1800 C	01-05	098025	RR69	1786,-	2233,-				
KAWASAKI									
KH 250 RR	73-79	098201	RR10	981,-	1226,-				
KLR 250	84-93	098106	RR60	968,-	1210,-				
EN 400	86	098105	RR26	981,-	1226,-				
KH 400	76-78	098106	RR60	968,-	1210,-				
Z 400 J	80	098106	RR60	968,-	1210,-				
ZXR 400 / ZZR	89-90	098105*/098111*	RR26/RR20	981,-	1226,-				
Z 440/LTD.	79-83	098106	RR60	968,-	1210,-				
EN 450	85-90	098308	RR14	964,-	1205,-				
EN 454	85-90	098308	RR14	964,-	1205,-				
EN 500	90-97	098308	RR14	964,-	1205,-				
ER-5	97-00	098019	RR15	1182,-	1478,-				
EX 500	87-97	098308	RR14	964,-	1205,-				
GPZ 500 S	88-92	098308	RR14	964,-	1205,-				
KH 500	74-79	098106	RR60	968,-	1210,-				
KLE 500		098308	RR14	964,-	1205,-				
Z 500	79-83	098106	RR60	968,-	1210,-				
GPZ 550 Unitrak	82-88	098105	RR26	981,-	1226,-				
GT 550	85	098101	RR14	961,-	1201,-				
ZR 550 F Unitrak	83-84	098101	RR14	961,-	1201,-				
GPZ 550 Uni-Trak	84	098108	RR37	1087,-	1359,-				
GPZ 550 A1		098105	RR26	981,-	1226,-				
KZ 550	80-84	098308	RR14	964,-	1205,-				
ZR 550 Zephyr	90-96	098105*/098111*	RR26/RR20	981,-/991,-	1226-/1239,-				
Z 550	80	098308*/098108*	RR14/RR37	964,-/1087,-	1205-/1359,-				
GPX 600 R	87-90	098105*/098111*	RR26/RR20	981,-/991,-	1226-/1239,-				
GPZ 600 R	86	098105*/098111*	RR26/RR20	981,-/991,-	1226-/1239,-				
KL 600	84-86	098105*/098106*	RR26/RR60	981,-/968,-	1226-/1210,-				

* Der kan være tale om to typer! - Se venligst illustrations-tegning./Jämför med bilden, det finns flera typer av just denna.

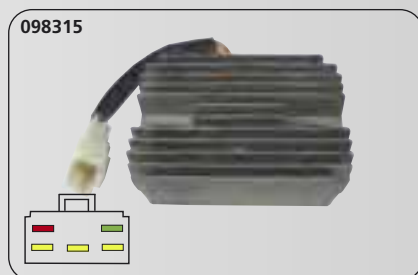
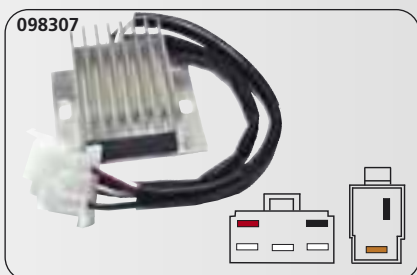
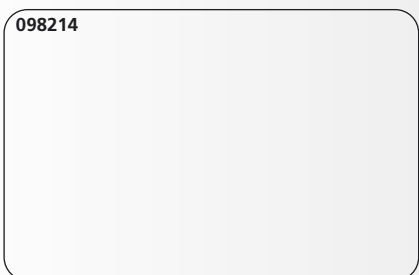
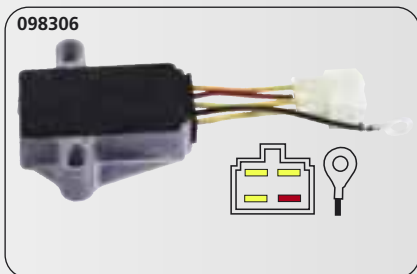
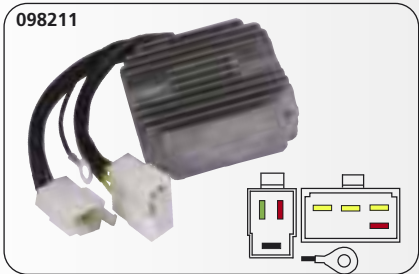
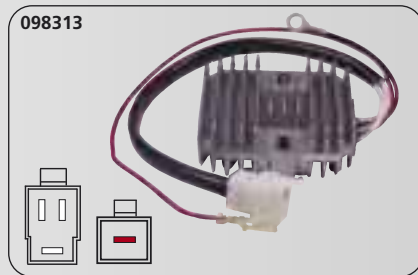
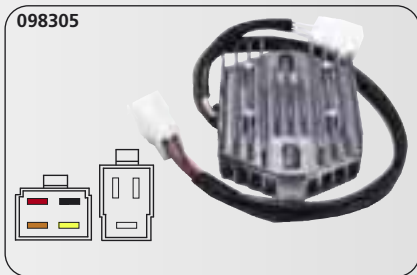
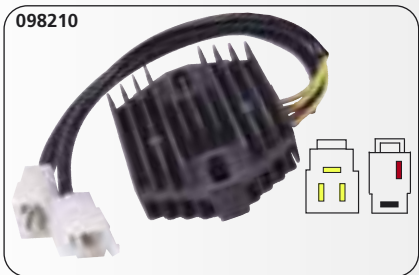
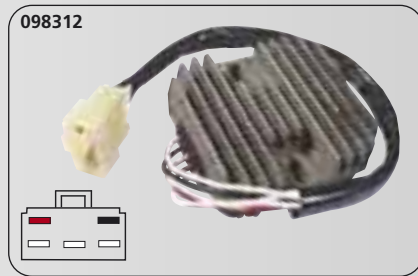
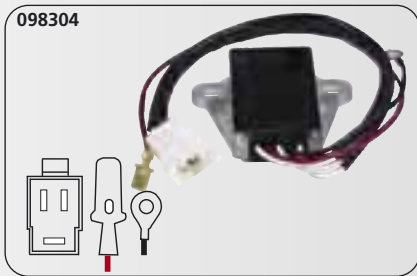
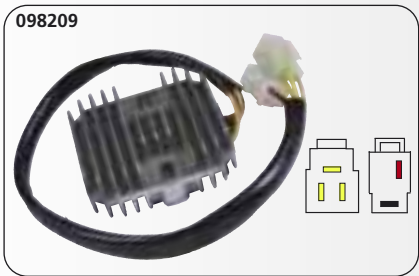
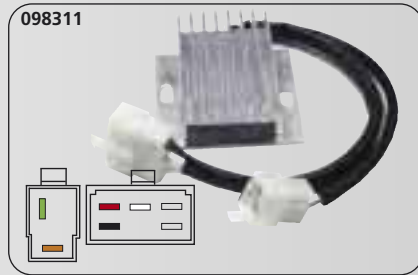
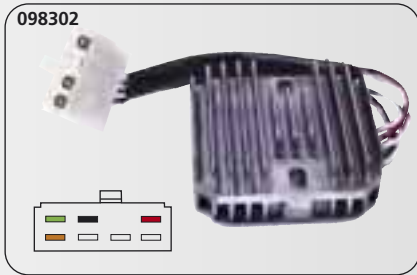
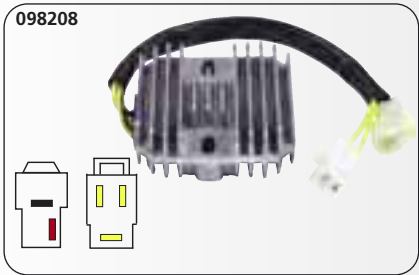
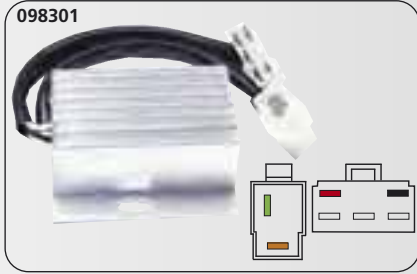
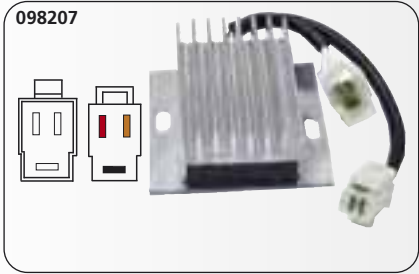
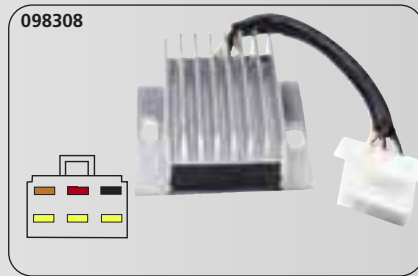
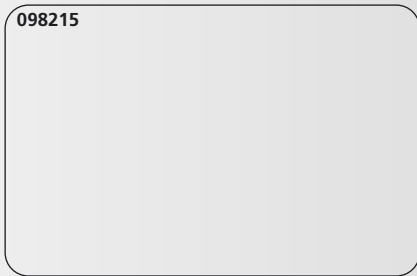
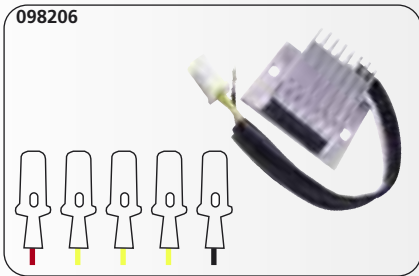

- Stikord Sökord s. 2-5
- Forhandlere Aterforsäljare s. 6-9
- Tøj/hjelme Kläder/hjälmar s. 11
- Dæk Däck s. 83
- Olje Olja s. 115
- Kæde/tandhjul Kedjor/drev s. 145
- Bremser Brems s. 187
- Låse Lås s. 347
- Batteri Batterier s. 355
- Pakninger Packningar s. 377
- Motordele Motordelar s. 411
- Lejer Lager s. 435
- Karburator Förgasare s. 467
- El-dele/ Tænding Elektriskt/Tänding s. 509**
- Blinklygter Baglygter Belysning Baklygter s. 611
- Lyddæmper Avgassystem s. 651
- Støddæmper Støtdåmpere s. 681
- Luft-/oliefilter Luft-/oljefilter s. 711
- Kobling Koppling s. 769
- Kabler Wire s. 803
- Styr/greb Styre/handtag s. 829
- Spejle og diverse Speglar och diverse s. 867
- Bøjer/værktøj Bøker/verktøy s. 893

* Der kan være tale om to typer ! - Se venligst illustrations-tegning./Jämför med bilden, det finns flera typer av just denna.

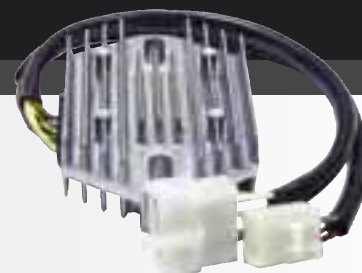

✚ Ensretter/voltregulatorer/Spændingsregulatorer

Fremstillet i Europa

✚ Likriktare/voltregulator/Spänningsregulator

Tillverkade i Europa

Mærke/ model	Prod. årg.	Ensrettere/Regulator Varenr.	Ref.nr.			Spændingsregulator Varenr.	Ref.nr.		
Märke/ modell	Prod. årg.	Likriktare/Regulator Art.nr.	Ref.nr.	DKK	SEK	Spänningsregulator Art.nr.	Ref.nr.	DKK	SEK
KAWASAKI									
KLR 600	84->	098105*/098106*	RR26/RR60	981,-/968,-	1226,-/1210:-				
ZL 600 Eliminator	95-98	098105	RR26	981,-	1226:-				
ZX6R Ninja	93-02					098401	RG25	751,-	939:-
ZX 6 R	98->	098105*/098111*	RR26/RR20	981,-/991,-	1226,-/1239:-				
ZX 6R J1	98->	098113	RR44	1653,-	2066:-				
ZZR 600	89-96	098105	RR26	981,-	1226:-				
KLR 650	87-96	098105	RR26	981,-	1226:-				
KLR 650 R/Tengai	84-92	098105	RR26	981,-	1226:-				
KLX 650 R	83-96	098105	RR26	981,-	1226:-				
KLX 650 R	93-96	098105	RR26	981,-	1226:-				
Z 650 B1	77-79	098104	RR34	981,-	1226:-				
Z 650 F1/B2/B3/C1/C2	81-84	098106	RR60	968,-	1210:-				
Z 650 F	83-84	098108	RR37	1087,-	1359:-				
Z 650 LTD./SR	79-83	098104	RR34	981,-	1226:-				
VN 700 Vulcan	85-95	098105	RR26	981,-	1226:-				
GPZ 750 Turbo	85	098308	RR14	964,-	1205:-				
GPZ 750 Uni-Trak A1/A3	83	098105	RR26	981,-	1226:-				
GPZ 750 R Ninja	85					098401	RG25	751,-	939:-
GT 750	86	098308*/098105*	RR14/RR26	964,-/981,-	1205,-/1226:-				
KZ 750	80-87	098308	RR14	964,-	1205:-				
VN 750 Vulcan	85-95	098105	RR26	981,-	1226:-				
Z 750 B (2-cyl.)	76-78	098106	RR60	968,-	1210:-				
Z 750 E/E1/L	80-84	098108	RR37	1087,-	1359:-				
ZXR 750	89-95					098401	RG25	751,-	939:-
ZX7R/RR	89-95					098401	RG25	751,-	939:-
ZR 750 Zephyr	91->	098105*/098111*	RR26/RR20	981,-/991,-	1226,-/1239:-				
VN 800 Vulcan/Classic	95->	098105*/098111*	RR26/RR20	981,-/991,-	1226,-/1239:-				
GPZ 900 R Ninja	85->					098401	RG25	751,-	939:-
Z 900	76-77	098201	RR10	981,-	1226:-				
ZL 900 Eliminator	85-86	098308	RR14	964,-	1205:-	098401	RG25	751,-	939:-
ZX9R	94->					098401	RG25	751,-	939:-
ZX9R C1	98->	098315	RR55	1635,-	2044:-				
ZX 10	89-97					098401	RG25	751,-	939:-
GPZ 1000 RX	86-89					098401	RG25	751,-	939:-
GTR 1000 Concours	86					098401	RG25	751,-	939:-
KZ 1000	87-97	098108	RR37	1087,-	1359:-				
Z 1000	76-78	098308	RR14	964,-	1205:-				
Z 1000 A/A1	77-80	098201	RR10	981,-	1226:-				
Z 1000 J	79-83	098308	RR14	964,-	1205:-				
Z 1000 MK II	79-80	098308	RR14	964,-	1205:-				
Z 1000 ST	79-81	098308	RR14	964,-	1205:-				
Z 1000 Z1R	78-80	098108	RR37	1087,-	1359:-				
Z 1000	02->	098111	RR20	991,-	1239:-				
ZL 1000 Eliminator	85-86	098308	RR14	964,-	1205:-	098401	RG25	751,-	939:-
GPZ 1100	95-97	098308	RR14	964,-	1205:-	098401	RG25	751,-	939:-
GPZ 1100 Uni-Trak	83-85	098308	RR14	964,-	1205:-	098401	RG25	751,-	939:-
ZN 1100	84	098105	RR26	981,-	1226:-				
ZR 1100 Zephyr	92->	098105*/098111*	RR26/RR20	981,-/991,-	1226,-/1239:-				
ZZR 1100 (ZX11)	89-97					098401	RG25	751,-	939:-
ZRX 1100	97->					098401	RG25	751,-	939:-
ZX 12 (1200)	98->	098113	RR44	1653,-	2066:-				
ZX 12 R		098113	RR44	1653,-	2066:-				
Z 1300 A1	79-84	098107	RR47	1245,-	1556:-				
Z 1300 EFI	85-89	098109	RR46	1139,-	1424:-				
VN 1500 SE	88-93	098112	RR86	1653,-	2066:-				
VN 1500 Vulcan/Classic	87	098112	RR86	1653,-	2066:-				
MATCHLESS									
Alle (Lucas nr. 49072)	63->	098400	LRC001	396,-	495:-				
MOTO GUZZI									
V35/V50/V65		098500	RR45	1199,-	1499:-				
850 Lemans	76	098500	RR45	1199,-	1499:-				
850 T/T3	75	098500	RR45	1199,-	1499:-				
1000 California	85	098500	RR45	1199,-	1499:-				
1000 Daytona	91	098501	RR51	1287,-	1609:-				
1000 Lemans	85-89	098500	RR45	1199,-	1499:-				
1000 SP	88-92	098500	RR45	1199,-	1499:-				
1000 Quata	92	098500*/098501*	RR45/RR51	1199,-	1499,-/1609:-				
1100 California	96	098501	RR51	1287,-	1609:-				
1100 Sport	96	098501	RR51	1287,-	1609:-				

* Der kan være tale om to typer ! - Se venligst illustrations-tegning./Jämför med bilden, det finns flera typer av just denna.

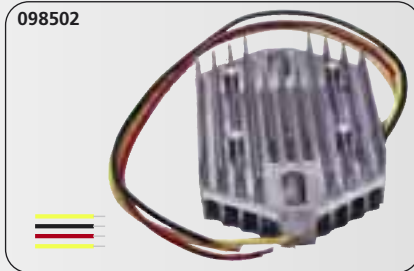
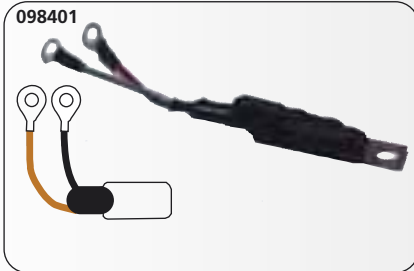
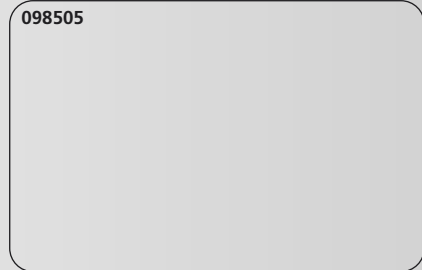
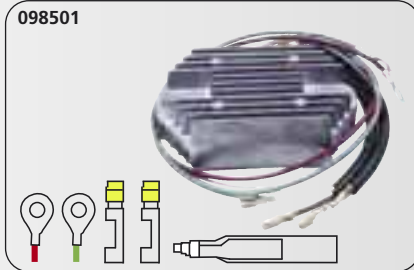
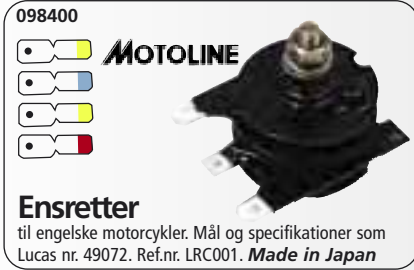
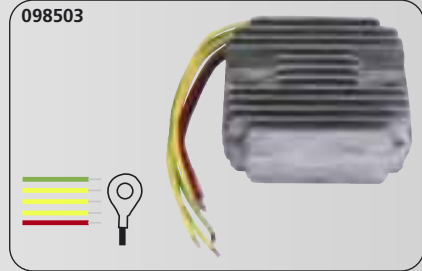
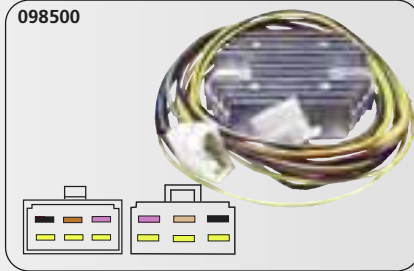
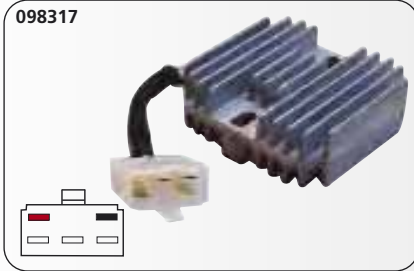

Mærke/ model	Prod. årg.	Ensrettere/Regulator Varenr.	Ref.nr.	Spændingsregulator Varenr.		Ref.nr.	
Mærke/ modell	Prod. årg.	Likriktare/Regulator Art.nr.	Ref.nr.	DKK	SEK	Spänningsregulator Art.nr.	
				DKK	SEK	DKK	SEK
NORTON							
Alle (Lucas nr. 49072)	57>	098400	LRC001	396,-	495,-		
Commando		098201	RR10	981,-	1226,-		
F1/Wankel		098201	RR10	981,-	1226,-		
ROYAL ENFIELD							
Alle (Lucas nr. 49072)	57>	098400	LRC001	396,-	495,-		
SUZUKI							
GN 250	82-96	098201	RR10	981,-	1226,-		
GSX 250	80-83	098201	RR10	981,-	1226,-		
DR 250 S	86-98	098207	RR27	961,-	1201,-		
RG 250		098206	RR13	981,-	1226,-		
RGV 250	89-94	098208	RR17	1042,-	1303,-		
DR 350	90-98	098213	RR73	969,-	1211,-		
GT 380	73-77	098211	RR77	1042,-	1303,-		
GN 400	80	098201	RR10	981,-	1226,-		
GS 400	76-81	098201	RR10	981,-	1226,-		
GS 400 E	89-96	098208	RR17	1042,-	1303,-		
GSF 400 Bandit	91	098208	RR17	1042,-	1303,-		
GSX 400 F	81-84	098206	RR13	981,-	1226,-		
GSX 400 T		098201	RR10	981,-	1226,-		
GSXR 400 (Import)		098208	RR17	1042,-	1303,-		
DRZ 400	00->	098208	RR17	1042,-	1303,-		
GS 425	78-80	098201	RR10	981,-	1226,-		
GN 450 (1 Cyl)		098206	RR13	981,-	1226,-		
GS 450 E/L/S	80-88	098201	RR10	981,-	1226,-		
GS 500 E	89-97	098208	RR17	1042,-	1303,-		
GS 500	04->	098208	RR17	1042,-	1303,-		
RG 500 Gamma	85-87	098206	RR13	981,-	1226,-		
GS 550 / Katana	77-83	098201	RR10	981,-	1226,-		
GS 550 L (16-Valve)	83	098202	RR11	981,-	1226,-		
GS 550 L (8-Valve)	79-82	098201	RR10	981,-	1226,-		
GSX 550 E/S	83-88	098202	RR11	981,-	1226,-		
GT 550	73-76	098211	RR77	1042,-	1303,-		
DR 600 S	85	098206	RR13	981,-	1226,-		
GSF 600 Bandit	95-97					098401	RG25 751,- 939,-
GSX 600 F	88-97					098401	RG25 751,- 939,-
GSXR 600 W	92-97					098401	RG25 751,- 939,-
GSXR 600 SRAD		098315	RR55	1635,-	2044,-		
GSXR 600 K1		098315*/098111*	RR55/RR20	1635,-/991,-	2044,-/1239,-		
RF 600 R	93-96					098401	RG25 751,- 939,-

* Der kan være tale om to typer ! - Se venligst illustrations-tegning./Jämför med bilden, det finns flera typer av just denna.

Stikord
Sökord
s. 2-5

Forhandlere
Aterforsaljare
s. 6-9

Tøj/hjelme
Klæder/
hjelmar
s. 11

Dæk
Däck
s. 83

Olie
Olja
s. 115

Kæde/
tandhjul
Kedjor/
drev
s. 145

Bremser
Broms
s. 187

Låse
Lås
s. 347

Batteri
Batterier
s. 355

Pakninger
Packingar
s. 377

Motordele
Motordelar
s. 411

Lejer
Lager
s. 435

Karburator
Förgasare
s. 467

El-dele/
Tænding
Elektriskt/
Tænding
s. 509

Blinklygter
Baglygter
Belysning
Baklykter
s. 611

Lyddæmper
Avgassystem
s. 651

Støddæmper
Støtdåmpare
s. 681

Luft/
oliefilter
Luft/
oljefilter
s. 711

Kobling
Koppling
s. 769

Kabler
Wire
s. 803

Styr/greb
Styre/
handtag
s. 829

Spejle
og diverse
Speglar
och diverse
s. 867

Bøger/
værktøj
Böcker/
verktyg
s. 893

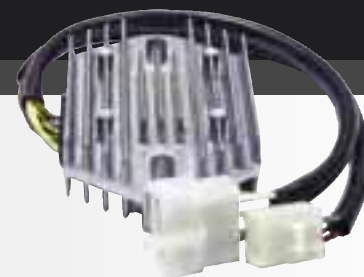

✚ Ensretter/voltregulatorer/Spændingsregulatorer

Fremstillet i Europa

✚ Likriktare/voltregulator/Spänningsregulator

Tillverkade i Europa

Märke/ model	Prod. årg.	Ensrettere/Regulator Varenr.	Ref.nr.		Spændingsregulator Varenr.	Ref.nr.		
Märke/ modell	Prod. årg.	Likriktare/Regulator Art.nr.	Ref.nr.	DKK	SEK	Spänningsregulator Art.nr.	Ref.nr.	DKK SEK
SUZUKI								
VS 600 Intruder	95-97	098204	RR75	1265,-	1581,-			
AN 650 Burgman	03-04	098315	RR55	1635,-	2044,-			
DL 650 V-Strom	04-06	098315	RR55	1635,-	2044,-			
DR 650 R/RE/Dakar	90-95	098201	RR10	981,-	1226,-			
GS 650 GL/GT/ Katana	81-86	098206	RR13	981,-	1226,-			
LS 650	86-88	098201	RR10	981,-	1226,-			
LS 650 Savage	95-98	098207	RR27	961,-	1201,-			
XF 650 Freewind	97-00	098207	RR27	961,-	1201,-			
SV 650/S	98-00	098212/098214	RR85/RR851					
VS 700 Intruder	86-91	098204	RR75	1265,-	1581,-			
GS 750	76-79	098201	RR10	981,-	1226,-			
GSX 750 E/ES	83-88	098206	RR13	981,-	1226,-			
GSX 750 E/L	81-83	098200	RR9	964,-	1205,-			
GSX 750 EF/ET	86-88	098206	RR13	981,-	1226,-			
GSX 750 F	89-97					098401	RG25	751,- 939,-
GSX 750 S	82-83	098200	RR9	964,-	1205,-			
GSXR 750	85-87					098401	RG25	751,- 939,-
GSX-R 750 SRAD	96-00	098315	RR55	1635,-	2044,-			
DR 750 S	89-91	098201	RR10	981,-	1226,-			
GT 750	73-77	098211	RR77	1042,-	1303,-			
VS 750 Intruder	86-91	098204	RR75	1265,-	1581,-			
VS 800 Intruder	91-97	098204	RR75	1265,-	1581,-			
VL 800		098315	RR55	1635,-	2044,-			
VX 800	90-96	098207	RR27	961,-	1201,-			
VZ 800 Marauder	97->	098209	RR56	1389,-	1736,-			
GS 850	79-81	098201	RR10	981,-	1226,-			
GS 850 G	81-88	098201*/098206*	RR10/RR13	981,-/981,-	1226,-/1226,-			
RF 900 R/S/TV	93-97					098401	RG25	751,- 939,-
GS 1000	78-80	098201	RR10	981,-	1226,-			
GS 1000 G	82-84	098201*/098206*	RR10/RR13	981,-/981,-	1226,-/1226,-			
GSX 1000/E	82-84	098200	RR9	964,-	1205,-			
TL 1000 S	97-00	098210	RR62	1417,-	1771,-			
DL 1000 V-strom	02->	098315	RR55	1635,-	2044,-			
GSX-R 1000	00-05	098315	RR55	1635,-	2044,-			
SV 1000/S	03-05	098315	RR55	1635,-	2044,-			
GS 1100G (16-Valve)	84-89	098206	RR13	981,-	1226,-			
GSX 1100 E/EF/ES	83-86	098206	RR13	981,-	1226,-			
GSX 1100 F/G	88-97					098401	RG25	751,- 939,-
GSX 1100 L/S	80-84	098200	RR9	964,-	1205,-			
GSX 1100 Katana	93	098206	RR13	981,-	1226,-			
GSXR 1100	85-92					098401	RG25	751,- 939,-
GSXR 1100 W	93-97					098401	RG25	751,- 939,-
GSF 1200 Bandit	95-97					098401	RG25	751,- 939,-
GSX-R 1300 Hayabusa	99-05	098315	RR55	1635,-	2044,-			
GSX 1400	01-05	098315	RR55	1635,-	2044,-			
VS 1400 Intruder	87-97	098204	RR75	1265,-	1581,-			
VL 1500		098315	RR55	1635,-	2044,-			
VZ 1600 Marauder	04	098315	RR55	1635,-	2044,-			
TRIUMPH								
Alle ældre typer	58->	098400	LRC001	396,-	495,-			
T 509 Speed Triple	96					098401	RG25	751,- 939,-
T 595 Daytona	96-98					098401	RG25	751,- 939,-
750/900 Daytona	91-92					098401	RG25	751,- 939,-
750/900 Trident	91					098401	RG25	751,- 939,-
900 Speed Triple	94					098401	RG25	751,- 939,-
900/1000/1200 Trophy	96					098401	RG25	751,- 939,-
YAMAHA								
RD 125 LC (MK1)	82->	098207	RR27	961,-	1201,-			
TDR 125	88-90	098306	RR98	621,-	776,-			
TZR 125	87	098207	RR27	961,-	1201,-			
RD 250 E	78-79	098308	RR14	964,-	1205,-			
RD 250 LC	84	098306	RR98	621,-	776,-			
SR 250	80	098309	RR7	981,-	1226,-			
TDR 250	88-90	098306	RR98	621,-	776,-			
TZR 250	87	098306	RR98	621,-	776,-			
TZR 250 V		098306	RR98	621,-	776,-			
XS 250	71-85	098307	RR38	1065,-	1331,-			
XV 250 Virago	88-08	098306	RR98	621,-	776,-			
RD 350 DX	75	098301	RR31	1065,-	1331,-			
RD 350 E	79	098308	RR14	964,-	1205,-			
RD 350 LCF/NF	88-90	098306	RR98	621,-	776,-			

* Der kan være tale om to typer ! - Se venligst illustrations-tegning./Jämför med bilden, det finns flera typer av just denna.

Ensretter/voltregulatorer/Spændingsregulatorer

Fremstillet i Europa

Likriktare/voltregulator/Spänningsregulator

Tillverkade i Europa



Mærke/ model	Prod. årg.	Ensrettere/Regulator Varenr.	Ref.nr.	Spændingsregulator Varenr.		Spänningsregulator Varenr.	
Mærke/ modell	Prod. årg.	Likriktare/Regulator Art.nr.	Ref.nr.	DKK	SEK	DKK	SEK
YAMAHA							
RD 350 YPVS	83-85	098306	RR98	621,-	776:-		
XS 360	71-85	098307	RR38	1065,-	1331:-		
FZR 400 RR / W	87-96	098306	RR98	621,-	776:-		
RD 400 E	79	098308	RR14	964,-	1205:-		
XS 400	71-85	098307	RR38	1065,-	1331:-		
XS 400 (Dohc)	82-87	098302	RR32	964,-	1205:-		
RD 500 LC	83-86	098306	RR98	621,-	776:-		
XS 500	76-86	098301	RR31	1065,-	1331:-		
SR 500	78	098317	RR54	969,-	1211:-		
XV 535 Virago	88-96	098313	RR48	1182,-	1478:-		
XJ 550	80-91	098302	RR32	964,-	1205:-		
XT 550	82-83	098309	RR7	981,-	1226:-		
XZ 550	82-84	098305	RR39	1260,-	1575:-		
FJ 600	84-91	098304	RR48	1069,-	1336:-		
FZ 600	86-88	098302	RR32	964,-	1205:-		
FZR 600	89-99	098304	RR48	1069,-	1336:-		
FZS 600 Fazer	98-03	098315	RR55	1635,-	2044:-		
TT 600	83-89	098309	RR7	981,-	1226:-		
XT 600	83-95	098309	RR7	981,-	1226:-		
XT 600 (el-start)	84-90	098306	RR98	621,-	776:-		
YZF 600 R	96-00	098105	RR26	981,-	1226:-		
XJ 600	80-91	098302	RR32	964,-	1205:-		
XJ 600 Diversion	92->	098304	RR48	1069,-	1336:-		
YZF R6	94->	098315	RR55	1635,-	2044:-		
XJ 650	80-83	098302	RR32	964,-	1205:-		
XS 650 (Points models)		098311	RR35	1030,-	1288:-		
XS 650 SE/US Coustom	80-81	098302	RR32	964,-	1205:-		
XVS 650 Drag Star	97-00	098111	RR20	991,-	1239:-		
SZR 660	96->	098105	RR26	981,-	1226:-		
XTZ 660	89-96	098111	RR20	991,-	1239:-		
XJ 700 Maxim	80->	098302	RR32	964,-	1205:-		
FZ 750	84-92					098401	RG25 751,- 939:-
FZR 750 R	87-95					098401	RG25 751,- 939:-
YZF 750	93-97	098012	RR25	1050,-	1313:-		
XJ 750	80-86	098302	RR32	964,-	1205:-		
XS 750/SE	77-82	098301	RR31	1065,-	1331:-		
XV 750 SE / Virago	81-96	098304	RR48	1069,-	1336:-		
YZF 750	89-96	098306*/098317*	RR98/RR54	621,-/969,-	776:-/1211:-		
TDM 850	94-99	098306	RR98	621,-	776:-		
TDM 850	00->	098312	RR40	1170,-	1463:-		
TDM 850	00->	098004	RR58	1287,-	1609:-		
TRX 850	95	098306*/098105*	RR98/RR26	621,-/981,-	776:-/1226:-		
XS 850	77-83	098301	RR31	1065,-	1331:-		
XJ 900	83-94	098302	RR32	964,-	1205:-		
XJ 900 Diversion	95-00					098401	RG25 751,- 939:-
XV 920 J/K (Kardan)	83	098105*/098305*	RR26/RR39	981,-/1260,-	1226:-/1575:-		
XV 920 R/J (Kæde)	84	098305	RR39	1260,-	1575:-		
XV 1000 TR1	81-85	098105	RR26	981,-	1226:-		
XV 1000 Virago	86-88	098305	RR39	1260,-	1575:-		
XV 1000 SE	83-85	098304	RR48	1069,-	1336:-		
FZR 1000	87-95					098401	RG25 751,- 939:-
GTS 1000						098401	RG25 751,- 939:-
YZF R1	96-02	098315	RR55	1635,-	2044:-		
YZF R1	03>	098315	RR55	1635,-	2044:-		
FZS 1000 Fazer	02>	098111	RR20	991,-	1239:-		
FJ 1100	83->					098401	RG25 751,- 939:-
XS 1100	78-83	098301	RR31	1065,-	1331:-		
XV 1100 Virago	87-97	098304*/098105*	RR28/RR26	1069,-	1336:-/1226:-		
XVS 1100 Dragstar	99-05	098111	RR20	991,-	1239:-		
FJ 1200	83-97					098401	RG25 751,- 939:-
V-MAX 1200	91-00	098304	RR48	1069,-	1336:-		
XJR 1200	95-00					098401	RG25 751,- 939:-
XVZ 1200	84-87	098314	RR36	1220,-	1525:-		
1300 Royal Star	96-97	098304*/098105*	RR48/RR26*	1069,-	1336:-/1226:-		
FJR 1300/A	03-05	098111	RR20	991,-	1239:-		
XJR 1300/SP	99-05					098401	RG25 751,- 939:-

* Der kan være tale om to typer ! - Se venligst illustrations-tegning./Jämför med bilden, det finns flera typer av just denna.

- Stikord Sökord s. 2-5
- Forhandlere Aterforsaljare s. 6-9
- Tøj/hjelme Klæder/hjælmar s. 11
- Dæk Dæk s. 83
- Olie Olja s. 115
- Kæde/ tandhjul Kedjor/drev s. 145
- Bremser Broms s. 187
- Låse Lås s. 347
- Batteri Batterier s. 355
- Pakninger Packningar s. 377
- Motordele Motordelar s. 411
- Lejer Lager s. 435
- Karburator Förgasare s. 467
- El-dele/ Tænding Elektriskt/ Tænding s. 509
- Blinklygter Baglygter Belysning Baklykter s. 611
- Lyddæmper Avgassystem s. 651
- Støddæmper Støtdåmpare s. 681
- Luft-/ oliefilter Luft-/ oljefilter s. 711
- Kobling Koppling s. 769
- Kabler Wire s. 803
- Styr/greb Styre/handtag s. 829
- Spejle og diverse Speglar och diverse s. 867
- Bøger/værktøj Bøcker/ verktyg s. 893

Denmark Bremselyskontakter for og bag
Sweden Bromsljuskontakter fram och bak



Mærke/ model	Prod. årg.	For Varenr.	Ref.nr.			Bag Varenr.	Ref.nr.		
Märke/ modell	Prod. årg.	Fram Art.nr.	Ref.nr.	DKK	SEK	Bak Art.nr.	Ref.nr.	DKK	SEK
HONDA									
CA 125 Rebell	95-00	174004	46-19430	57,-	71:-				
CB 125 T	78-86	174025	46-19435	75,-	94:-	174000	46-37100	51,-	64:-
CBR 125	04-07	174004	46-19430	57,-	71:-				
CLR 125 Cityfly	99-00	174004	46-19430	57,-	71:-				
FES 125 Pantheon	98-06	174004	46-19430	57,-	71:-				
NES 125 @	00-02	174004	46-19430	57,-	71:-				
NH 125 Lead	83-86	174025	46-19435	75,-	94:-				
NSR 125	97-03	174004	46-19430	57,-	71:-				
SES 125 Dylan	03-06	174004	46-19430	57,-	71:-				
SH 125	02-06	174004	46-19430	57,-	71:-				
VT 125 Shadow	99-06	174004	46-19430	57,-	71:-				
XL/TL 125	76-78	174025	46-19435	75,-	94:-	174000	46-37100	51,-	64:-
XL 125 Varadero	01-06	174004	46-19430	57,-	71:-				
XLR 125	98-99	174004	46-19430	57,-	71:-				
XR 125	02-06	174004	46-19430	57,-	71:-				
CM 185/200 T	78-84					174000	46-37100	51,-	64:-
XL 185 S	81-83	174025	46-19435	75,-	94:-				
MTX 200 R	85-88	174004	46-19430	57,-	71:-				
CB 250 Euro	78-80		46-19400			174000	46-37100	51,-	64:-
CB 250 Euro	81-83	174004	46-19430	57,-	71:-	174000	46-37100	51,-	64:-
CB 250 RS	80-84		46-19400			174000	46-37100	51,-	64:-
CB 250 T	76-78					174000	46-37100	51,-	64:-
CB 250 Two Fifty	96-98	174004	46-19430	57,-	71:-				
CJ 250	76-78					174000	46-37100	51,-	64:-
CMX 250 Rebell	96-99	174004	46-19430	57,-	71:-				
CN 250 Helix	86-99	174004	46-19430	57,-	71:-				
FES 250 Foresight	98-00	174004	46-19430	57,-	71:-				
NX 250	88-95	174004	46-19430	57,-	71:-				
XL 250 K	76-78	174025	46-19435	75,-	94:-	174000	46-37100	51,-	64:-
XL 250/350 R	84-88	174004	46-19430	57,-	71:-				
CB 350 Four	72-74					174000	46-37100	51,-	64:-
CB 350 Four						174011		32,-	40:-
CB 400 F						174011		32,-	40:-
CB 400 F						174000	46-37100	51,-	64:-
CB 1 400	89-90	174004	46-19430	57,-	71:-				
CB 400 Euro	78-85	174004	46-19430	57,-	71:-	174000	46-37100	51,-	64:-
CM 400 T	80		46-19400			174000	46-37100	51,-	64:-
CM 400 T	81-83	174004	46-19430	57,-	71:-	174000	46-37100	51,-	64:-
NS 400	85-86	174004	46-19430	57,-	71:-	174000	46-37100	51,-	64:-
VFR 400	91	174004	46-19430	57,-	71:-				
XR 400	96-02	174004	46-19430	57,-	71:-				
CB 450 N	85	174004	46-19430	57,-	71:-	174000	46-37100	51,-	64:-
CB 500 F						174000	46-37100	51,-	64:-
CB 500 F						174011		32,-	40:-
CB 500	94-03	174004	46-19430	57,-	71:-				
CBF 500	04-05	174004	46-19430	57,-	71:-				
CX 500	77-80	174004	46-19430	57,-	71:-				
CX 500	81-83	174004	46-19430	57,-	71:-				
CX 500 C/ EURO/ TURBO	82-86	174004	46-19430	57,-	71:-				
FT 500	82-83	174004	46-19430	57,-	71:-				
GL 500 Silverwing	82-83	174004	46-19430	57,-	71:-				
VF 500 F	84-87	174004	46-19430	57,-	71:-				
VT 500 C/ E	83-85	174004	46-19430	57,-	71:-				
XBR 500	85-89	174004	46-19430	57,-	71:-				
XL 500 R	82-85	174025	46-19435	75,-	94:-				
CB 550 F						174011		32,-	40:-
CBX 550 F						174000	46-37100	51,-	64:-
CBX 550 F	82-84	174004	46-19430	57,-	71:-	174027	46-37090	75,-	94:-
CB 600 Hornet	98-03	174004	46-19430	57,-	71:-				
CBF 600	04-05	174004	46-19430	57,-	71:-				
CBR 600 F	87-05	174004	46-19430	57,-	71:-				
FJS 600 Silver Wing	01-05	174004	46-19430	57,-	71:-				
VT 600 C Shadow	88-00	174004	46-19430	57,-	71:-				
XL 600 R / Paris Dakar	83-87	174004	46-19430	57,-	71:-				
XL 600/650 Trans Alp	87-06	174004	46-19430	57,-	71:-				
XR 600/650	87-06	174004	46-19430	57,-	71:-				
CB 650	79-80	174004	46-19430	57,-	71:-				
CB 650	81-82	174004	46-19430	57,-	71:-				
CB 650 C	80	174004	46-19430	57,-	71:-				
CB 650 C	81-83	174004	46-19430	57,-	71:-				
CBX 650 E	83-84	174004	46-19430	57,-	71:-				
CX 650 C/ EURO/ TURBO	83-85	174004	46-19430	57,-	71:-				
FMX 650	05-06	174004	46-19430	57,-	71:-				

174001 OEM nr.:
For / fram 57460-49300

174004 OEM nr.:
For / fram 35350-MAS-671
 35340-MM5-600
 35340-ML7-000

174005 OEM nr.:
For / fram 57460-17C00
 27010-1170

174006 OEM nr.:
For / fram 1A0-83980-30
 2GH-83980-00

174016 OEM nr.:
For / fram 3GY-83917-00

174017 OEM nr.:
For / fram J45-82503-01

Bremselyskontakter for og bag
Bromsljuskontakter fram och bak



Mærke/ model	Prod. årg.	For Varenr.	Ref.nr.			Bag Varenr.	Ref.nr.		
Märke/ modell	Prod. årg.	Fram Art.nr.	Ref.nr.	DKK	SEK	Bak Art.nr.	Ref.nr.	DKK	SEK
HONDA									
FX 650 Vigor	99-00	174004	46-19430	57,-	71,-				
GL 650 Silver Wing	83	174004	46-19430	57,-	71,-				
NT 650 Deauville	98-05	174004	46-19430	57,-	71,-				
NT 650 Hawk	88-90	174004	46-19430	57,-	71,-				
NTV 650 Revere	88-97	174004	46-19430	57,-	71,-				
NX 650 Dominator	88-00	174004	46-19430	57,-	71,-				
SLR 650	97-98	174004	46-19430	57,-	71,-				
XRV 650/750 Africa Twin	86-03	174004	46-19430	57,-	71,-				
CB 750 F/K						174000	46-37100	51,-	64,-
CB 750 F/K						174011		32,-	40,-
CB 750 Bol d'Or	80	174026	46-19400	69,-	86,-				
CB 750 Bol d'Or	81-82	174004	46-19430	57,-	71,-				
CB 750 C	81-83	174004	46-19430	57,-	71,-				
CB 750 KZ	78-80	174026	46-19400	69,-	86,-				
CB 750 Seven Fifty	92-03	174004	46-19430	57,-	71,-				
CBX 750	84-86	174004	46-19430	57,-	71,-				
RVF 750	94-97	174004	46-19430	57,-	71,-				
VF 750 C/ F/ S	83-84	174004	46-19430	57,-	71,-				
VF 750 Magna	93-00	174004	46-19430	57,-	71,-				
VFR 750 F	86-97	174004	46-19430	57,-	71,-				
VT 750 Black Widow	00-03	174004	46-19430	57,-	71,-				
VT 750 Shadow	97-06	174004	46-19430	57,-	71,-				
XLV 750	83-85	174004	46-19430	57,-	71,-				
VFR 800	98-05	174004	46-19430	57,-	71,-				
CB 900 Bol d'Or	79-81	174004	46-19430	57,-	71,-				
CB 900 Bol d'Or	82-83	174004	46-19430	57,-	71,-				
CB 900 Hornet	02-05	174004	46-19430	57,-	71,-				
CBR 900 Fireblade	92-03	174004	46-19430	57,-	71,-				
CB 1000 Super Four	93-96	174004	46-19430	57,-	71,-				
CBR 1000 F	87-00	174004	46-19430	57,-	71,-				
CBX 1000 Pro Link	81-84	174004	46-19430	57,-	71,-	174027	46-37090	75,-	94,-
GL 1000 Gold Wing	78-79	174026	46-19400	69,-	86,-	174000	46-37100	51,-	64,-
VF 1000 F	84-86	174004	46-19430	57,-	71,-				
XL 1000 Varadero	99-06	174004	46-19430	57,-	71,-				
CB 1100 Super Bol d'Or	81-84	174004	46-19430	57,-	71,-				
CB 1100 X-11	00-03	174004	46-19430	57,-	71,-				
CBR 1100 XX	97-06	174004	46-19430	57,-	71,-				
GL 1100 Gold Wing	80-83	174026	46-19400	69,-	86,-	174027	46-37090	75,-	94,-
ST 1100 Pan European	90-01	174004	46-19430	57,-	71,-				
VF 1100 Magna	83-86	174004	46-19430	57,-	71,-				
VT 1100 Shadow	88-00	174004	46-19430	57,-	71,-				
VTR 1000	97-05	174004	46-19430	57,-	71,-				
GL 1200 Gold Wing	84-88	174004	46-19430	57,-	71,-				
CB 1300	01-05	174004	46-19430	57,-	71,-				
CB 1300 X-4	97-99	174004	46-19430	57,-	71,-				
ST 1300 Pan European	02-05	174004	46-19430	57,-	71,-				
VTX 1300	03-06	174004	46-19430	57,-	71,-				
GL 1500 F6C Valkyrie	97-03	174004	46-19430	57,-	71,-				
VTX 1800	02-06	174004	46-19430	57,-	71,-				
KAWASAKI									
BJ 250 Estrella	94-99	174005	46-50750	96,-	120,-				
EL 250/252 Eliminator	88-03	174005	46-50750	96,-	120,-				
KLR 250	84-90	174028	46-50760	75,-	94,-				
Z 250 Belt Drive	83	174028	46-50760	75,-	94,-				
ZZR 250		174005	46-50750	96,-	120,-				
GPZ 305	84-89	174028	46-50760	75,-	94,-				
Z 305	83	174028	46-50760	75,-	94,-				
GPZ 400	85	174028	46-50760	75,-	94,-				
Z 400	83-84	174028	46-50760	75,-	94,-				
ZXR 400	91-99	174005	46-50750	96,-	120,-				
Z 440 Belt Drive	84	174028	46-50760	75,-	94,-				
EN 450 LTD	85-89	174028	46-50760	75,-	94,-				
EN 500	90-03	174005	46-50750	96,-	120,-				
ER 500 Twister	97-06	174005	46-50750	96,-	120,-				
GPZ 500 S	87-03	174005	46-50750	96,-	120,-				
KLE 500	91-07	174005	46-50750	96,-	120,-				
GPZ 550 Unitrak	84-89	174028	46-50760	75,-	94,-				
GT 550	83-89	174028	46-50760	75,-	94,-				
Z 550	82-83	174028	46-50760	75,-	94,-				
ZR 550 A	83	174028	46-50760	75,-	94,-				
ZR 550 Zephyr	91-99	174005	46-50750	96,-	120,-				
GPX 600 R	88-99	174005	46-50750	96,-	120,-				
GPZ 600 R	85-90	174005	46-50750	96,-	120,-				

174022 OEM nr.:
For / fram 54-33234

174000 OEM nr.:
Bag / bak 35350-292-003

174003 OEM nr.:
Bag / bak 1J7-82530-00

174011 OEM nr.:
Honda CD 50 K1
Bag / bak 35350-051-000

174015 OEM nr.:
Bag / bak 37740-48071

- Stikord Søkkord s. 2-5
- Forhandlere Aterforsaljare s. 6-9
- Tøj/hjelme Klæder/hjælmar s. 11
- Dæk Dækk s. 83
- Olje Olja s. 115
- Kæde/tandhjul Kedjor/drev s. 145
- Bremser Broms s. 187
- Låse Lås s. 347
- Batteri Batterier s. 355
- Pakninger Pakningar s. 377
- Motordele Motordelar s. 411
- Lejer Lager s. 435
- Karburator Förgasare s. 467
- El-dele/ Tænding Elektriskt/Tänding s. 509
- Blinklygter Baglygter Belysning Baklykter s. 611
- Lyddæmper Avgassystem s. 651
- Støddæmper Støtdämpare s. 681
- Luft/oliefilter Luft/oljefilter s. 711
- Kobling Koppling s. 769
- Kabler Wire s. 803
- Styr/greb Styre/handtag s. 829
- Spejle og diverse Speglar och diverse s. 867
- Bøger/værktøj Böcker/verktyg s. 893

Bremsekontakt for og bag
Bromsljuskontakt fram och bak



Mærke/ model	Prod. årg.	For Varenr.	Ref.nr.			Bag Varenr.	Ref.nr.		
Märke/ modell	Prod. årg.	Fram Art.nr.	Ref.nr.	DKK	SEK	Bak Art.nr.	Ref.nr.	DKK	SEK
KAWASAKI									
KLR 600	84-89	174028	46-50760	75,-	94:-				
ZL 600	95-97	174005	46-50750	96,-	120:-				
ZX 6 R	95-97	174005	46-50750	96,-	120:-				
ZX 6 R	98-99	174005	46-50750	96,-	120:-				
ZX 6 R	00-02	174005	46-50750	96,-	120:-				
ZZR 600	90-04	174005	46-50750	96,-	120:-				
ER 6 N/F	fra 05	174005	46-50750	96,-	120:-				
KLR 650 A/B Tengai	87-91	174005	46-50750	96,-	120:-				
GPX 750 R	87-88	174005	46-50750	96,-	120:-				
GPZ 750 R	85	174005	46-50750	96,-	120:-				
GPZ 750 Unitrak	85	174028	46-50760	75,-	94:-				
GT 750	82-85	174028	46-50760	75,-	94:-				
VN 750	86-92	174028	46-50760	75,-	94:-				
VN 750	93-95	174005	46-50750	96,-	120:-				
Z 750	82-84	174028	46-50760	75,-	94:-				
Z 750	04-06	174005	46-50750	96,-	120:-				
ZR 750 Zephyr	91-99	174005	46-50750	96,-	120:-				
ZR 7 /S	99-04	174005	46-50750	96,-	120:-				
ZX 750 Turbo	84-85	174028	46-50760	75,-	94:-				
ZXR 750	89-95	174005	46-50750	96,-	120:-				
ZX 7 R	96-99	174005	46-50750	96,-	120:-				
VN 800 / Classic	95-03	174005	46-50750	96,-	120:-				
GPZ 900 R	84-94	174005	46-50750	96,-	120:-				
ZL 900/1000	85-88	174005	46-50750	96,-	120:-				
ZX 9 R	94-97	174005	46-50750	96,-	120:-				
ZX 9 R	98-99	174005	46-50750	96,-	120:-				
ZX 9 R	00-03	174005	46-50750	96,-	120:-				
GPZ 1000 RX	86-87	174005	46-50750	96,-	120:-				
GTR 1000	86-03	174005	46-50750	96,-	120:-				
Z 1000 R	83	174028	46-50760	75,-	94:-				
Z 1000	03-05	174005	46-50750	96,-	120:-				
ZX 10	88-90	174005	46-50750	96,-	120:-				
GPZ 1100 Horizont	95-98	174005	46-50750	96,-	120:-				
GPZ 1100 Unitrak	83-85	174028	46-50760	75,-	94:-				
Z 1100 GP B2	82	174028	46-50760	75,-	94:-				
ZR 1100 Zephyr	91-97	174005	46-50750	96,-	120:-				
ZRX 1100	97-00	174005	46-50750	96,-	120:-				
ZZR 1100	90-01	174005	46-50750	96,-	120:-				
ZRX 1200	01-05	174005	46-50750	96,-	120:-				
ZX 12 R	00-06	174005	46-50750	96,-	120:-				
ZZR 1200	02-05	174005	46-50750	96,-	120:-				
Z 1300 DFI	84-89	174028	46-50760	75,-	94:-				
VN 1500	88-95	174005	46-50750	96,-	120:-				
SUZUKI									
AN 125	95-99	174005	46-50750	96,-	120:-				
DR 125	95-00	174005	46-50750	96,-	120:-				
GN 125	94-99	174005	46-50750	96,-	120:-				
GS 125	99	174005	46-50750	96,-	120:-				
GZ 125 Marauder	98-05	174005	46-50750	96,-	120:-				
RV 125 Van Van	03	174005	46-50750	96,-	120:-				
TU 125	99	174005	46-50750	96,-	120:-				
UC 125 Epicuro	99-02	174005	46-50750	96,-	120:-				
UE 125	01-03	174005	46-50750	96,-	120:-				
UH 125 Burgman	fra 02	174005	46-50750	96,-	120:-				
VL 125 Intruder	00-04	174005	46-50750	96,-	120:-				
AN 250 Burgman	98-99	174005	46-50750	96,-	120:-				
GN/GNX 250	82-93	174029	46-37130	75,-	94:-				
GN 250	94-99	174005	46-50750	96,-	120:-	174015	46-50812	40,-	50:-
GSX 250	80-83	174029	46-37130	75,-	94:-				
GT 250 X-7E	79-81	174029	46-37130	75,-	94:-				
GZ 250						174015	46-50812	40,-	50:-
GZ 250 Marauder	99-01	174005	46-50750	96,-	120:-				
RG 250 Gamma	86-88	174029	46-37130	75,-	94:-				
RGV 250	89-93	174005	46-50750	96,-	120:-				
LT-Z 250 QuadSport	04	174005	46-50750	96,-	120:-				
TU 250						174015	46-50812	40,-	50:-
DR 350	90-97	174005	46-50750	96,-	120:-				
AN 400 Burgman	99-02	174005	46-50750	96,-	120:-				
DR-Z 400	fra 00	174005	46-50750	96,-	120:-				
GN 400	80-82	174029	46-37130	75,-	94:-				
GS 400	77-83	174029	46-37130	75,-	94:-				
GSF 400 Bandit	91-95	174005	46-50750	96,-	120:-				
GSX 400	80-87	174029	46-37130	75,-	94:-				

Bremselyskontakter for og bag
Bromsljuskontakter fram och bak



Mærke/ model	Prod. årg.	For Varenr.	Ref.nr.	DKK	SEK	Bag Varenr.	Ref.nr.	DKK	SEK
Märke/ modell	Prod. årg.	Fram Art.nr.	Ref.nr.	DKK	SEK	Bak Art.nr.	Ref.nr.	DKK	SEK
SUZUKI									
GSX 400 Katana	81-83	174029	46-37130	75,-	94,-				
GSX 400 S	80-87	174029	46-37130	75,-	94,-				
LT-A/ LT-F 400 Eiger	02-04	174005	46-50750	96,-	120,-				
GS 450	80-88	174029	46-37130	75,-	94,-	174015	46-50812	40,-	50,-
RG 500 Gamma	86-89	174029	46-37130	75,-	94,-				
GS 500 E	89-06	174005	46-50750	96,-	120,-	174015	46-50812	40,-	50,-
GS 500/550 / Katana	77-83	174029	46-37130	75,-	94,-				
GSX 550 E/ES/EF	83-87	174029	46-37130	75,-	94,-				
GSF 600 Bandit	95-04	174005	46-50750	96,-	120,-				
GSX 600 F	88	174029	46-37130	75,-	94,-				
GSX 600 F	89-01	174005	46-50750	96,-	120,-				
GSX-R 600	97-03	174005	46-50750	96,-	120,-				
RF 600	93-96	174005	46-50750	96,-	120,-				
VS 600 Intruder	95-97	174005	46-50750	96,-	120,-				
AN 650 Burgman	fra 02	174005	46-50750	96,-	120,-				
DR 650 R/RS/RE/RSE/SE	90-00	174005	46-50750	96,-	120,-				
GR 650	83-89	174029	46-37130	75,-	94,-				
GS 650						174015	46-50812	40,-	50,-
GS 650 G Katana	81-83	174029	46-37130	75,-	94,-				
LS 650 Savage	86-00	174005	46-50750	96,-	120,-				
SV 650	99-03	174005	46-50750	96,-	120,-				
XF 650 Freewind	97-02	174005	46-50750	96,-	120,-				
DR 750/800 Big	88-99	174005	46-50750	96,-	120,-				
GS 750	77-79	174029	46-37130	75,-	94,-				
GSX 750						174015	46-50812	40,-	50,-
GSX 750 E/L	80-83	174029	46-37130	75,-	94,-				
GSX 750 ES/EF	83-87	174029	46-37130	75,-	94,-				
GSX 750 S Katana	81-83	174029	46-37130	75,-	94,-				
GSX 750 F	89-03	174005	46-50750	96,-	120,-				
GSX 750 Naked	98-03	174005	46-50750	96,-	120,-				
GSX-R 750	85-87	174029	46-37130	75,-	94,-				
GSX-R 750	88-03	174005	46-50750	96,-	120,-				
VS 750/800 Intruder	89-00	174005	46-50750	96,-	120,-				
VL 800 Volusia	01-03	174005	46-50750	96,-	120,-				
VX 800	90-97	174005	46-50750	96,-	120,-				
VZ 800 Marauder	97-03	174005	46-50750	96,-	120,-				
GS 850 G	79-86	174029	46-37130	75,-	94,-	174015	46-50812	40,-	50,-
RF 900	94-97	174005	46-50750	96,-	120,-				
DL 1000 V-Strom	fra 02	174005	46-50750	96,-	120,-				
GS 1000	78-81	174029	46-37130	75,-	94,-	174015	46-50812	40,-	50,-
GSX-R 1000	01-03	174005	46-50750	96,-	120,-				
SV 1000	fra 03	174005	46-50750	96,-	120,-				
TL 1000 S	97-02	174005	46-50750	96,-	120,-				
GS 1100 G	84-86		46-37130			174015	46-50812	40,-	50,-
GSX 1100						174015	46-50812	40,-	50,-
GSX 1100 E/L	80-83	174029	46-37130	75,-	94,-				
GSX 1100 ES/EF	83-87	174029	46-37130	75,-	94,-				
GSX 1100 S Katana	82-84	174029	46-37130	75,-	94,-				
GSX 1100 F	89-96	174005	46-50750	96,-	120,-				
GSX 1100 G	91-95	174005	46-50750	96,-	120,-				
GSX-R 1100	86-88	174029	46-37130	75,-	94,-				
GSX-R 1100	89-97	174005	46-50750	96,-	120,-				
GSF 1200 Bandit	96-05	174005	46-50750	96,-	120,-				
GSX 1200 Inazuma	99-00	174005	46-50750	96,-	120,-				
GSX 1300 R Hayabusa	99-03	174005	46-50750	96,-	120,-				
GSX 1400	fra 02	174005	46-50750	96,-	120,-				
VS 1400 Intruder	87-03	174005	46-50750	96,-	120,-				
VL 1500									
Legendary Classic	98-03	174005	46-50750	96,-	120,-				
YAMAHA									
Til mange modeller						174003	46-50700	57,-	71,-
RD 125/200	75-84	174006	46-50720	62,-	78,-				
DT 125/175 MX	78-83	174030	46-50710	51,-	64,-				
DT 250/400 MX	77-82	174030	46-50710	51,-	64,-				
XT 250	80-90	174030	46-50710	51,-	64,-				
RD 250/400	76-79	174006	46-50720	62,-	78,-				
RD 250/350 LC YPVS	80-84	174006	46-50720	62,-	78,-				
RD 350 N/F YPVS	84-89	174017	46-50740	111,-	139,-				
XS 250/400	78-82	174006	46-50720	62,-	78,-	174031	46-37120	57,-	71,-
FZR 400 RR	90-92		46-50750						
XS 400 DOHC	82-84	174006	46-50720	62,-	78,-	174031	46-37120	57,-	71,-
XS 400 SE	81-83	174006	46-50720	62,-	78,-	174031	46-37120	57,-	71,-
YP 400 Majesty	04-06	174017	46-50740	111,-	139,-				

- Stikord Søikor s. 2-5
- Forhandlere Aterforsaljare s. 6-9
- Tøj/hjelme Klæder/hjælmar s. 11
- Dæk Dæk s. 83
- Olje Olja s. 115
- Kæde/tandhjul Kedjor/drev s. 145
- Bremser Broms s. 187
- Låse Lås s. 347
- Batteri Batterier s. 355
- Pakninger Packningar s. 377
- Motordele Motordelar s. 411
- Lejer Lager s. 435
- Karburator Förgasare s. 467
- El-dele/Tænding Elektriskt/Tænding s. 509
- Blinklygter Baglygter Belysning Baklygter s. 611
- Lyddæmper Avgassystem s. 651
- Støddæmper Støtdämpare s. 681
- Luft-/oliefilter Luft-/oljefilter s. 711
- Kobling Koppling s. 769
- Kabler Wire s. 803
- Styr/greb Styre/handtag s. 829
- Spejle og diverse Speglar och diverse s. 867
- Bøger/værktøj Böcker/verktyg s. 893

Denmark Bremselyskontakter for og bag
Sweden Bromsljuskontakter fram och bak



Mærke/ model	Prod. årg.	For Varenr.	Ref.nr.			Bag Varenr.	Ref.nr.		
Märke/ modell	Prod. årg.	Fram Art.nr.	Ref.nr.	DKK	SEK	Bak Art.nr.	Ref.nr.	DKK	SEK
YAMAHA									
RD 500 LC YPVS	84-85	174017	46-50740	111,-	139,-				
SR 500 Skivebremse	78-89	174006	46-50720	62,-	78,-				
XP 500 T-MAX	01-06	174017	46-50740	111,-	139,-				
XV 500 Special	83	174006	46-50720	62,-	78,-				
XV 535	88-03	174006	46-50720	62,-	78,-				
XJ 550	81-84	174006	46-50720	62,-	78,-	174031	46-37120	57,-	71,-
XZ 550	82-84	174006	46-50720	62,-	78,-				
FZR 600	89-93	174017	46-50740	111,-	139,-				
FZR 600 R	94-95	174005	46-50750	96,-	120,-				
FZS 600 Fazer	98-03	174005	46-50750	96,-	120,-				
SRX 600	86-89	174017	46-50740	111,-	139,-				
TT 600	83-84	174030	46-50710	51,-	64,-				
XJ 600	84-91	174017	46-50740	111,-	139,-				
XT 600 Tenere	83-85	174006	46-50720	62,-	78,-				
YZF 600 Thundercat	96-01	174005	46-50750	96,-	120,-				
YZF 600 R6	99-03	174005	46-50750	96,-	120,-				
XJ 650	80-85	174006	46-50720	62,-	78,-	174031	46-37120	57,-	71,-
XS 650 /SE	75-83	174006	46-50720	62,-	78,-	174031	46-37120	57,-	71,-
XVS 650									
Drag Star/ Classic	97-06	174017	46-50740	111,-	139,-				
FZ 750 Genesis	85-94	174017	46-50740	111,-	139,-				
FZR 750 Genesis	87-88	174017	46-50740	111,-	139,-				
FZX 750 Fazer	87-89	174017	46-50740	111,-	139,-				
XJ 750 Seca	84	174006	46-50720	62,-	78,-	174031	46-37120	57,-	71,-
XS 750 / US-Custom	77-82	174006	46-50720	62,-	78,-	174031	46-37120	57,-	71,-
XV 750 SE	81-84	174006	46-50720	62,-	78,-				
XV 750 Virago	92-97	174006	46-50720	62,-	78,-				
YZF 750	fra 93	174005	46-50750	96,-	120,-				
TRX 850	96-99	174005	46-50750	96,-	120,-				
XS 850	80-82	174006	46-50720	62,-	78,-	174031	46-37120	57,-	71,-
XJ 900	83-84	174006	46-50720	62,-	78,-	174031	46-37120	57,-	71,-
XJ 900	85-94	174017	46-50740	111,-	139,-				
FZR 1000 Genesis	87-88	174017	46-50740	111,-	139,-				
FZR 1000 Exup	89-90	174006	46-50720	62,-	78,-				
FZR 1000 Exup	91-95	174005	46-50750	96,-	120,-				
FZS 1000 Fazer	01-05	174005	46-50750	96,-	120,-				
XV 1000									
Midnight Special	83-85	174006	46-50720	62,-	78,-				
XV 1000 TR1	81-84	174006	46-50720	62,-	78,-				
XV 1000/1100 Virago	86-99	174006	46-50720	62,-	78,-				
YZF 1000 Thunderace	fra 96	174005	46-50750	96,-	120,-				
YZF 1000 R1	98-03	174005	46-50750	96,-	120,-				
BT 1100 Bulldog	02-04	174005	46-50750	96,-	120,-				
FJ 1100	84-85	174017	46-50740	111,-	139,-				
XS 1100 /S	80-83	174006	46-50720	62,-	78,-				
XVS 1100									
Drag Star/ Classic	99-06	174017	46-50740	111,-	139,-				
FJ 1200	86-97	174017	46-50740	111,-	139,-				
V-MAX 1200	85-02	174017	46-50740	111,-	139,-				
XVZ 1200 Venture Royal	84-85	174006	46-50720	62,-	78,-				
XJR 1200	95-98	174005	46-50750	96,-	120,-				
XJR 1300	99-03	174006	46-50720	62,-	78,-				
TRIUMPH									
Triumph	61-70	174022	54-33234	169,-	211,-				

☐ Bremselyskontakter Universal
☐ Bromsljuskontakter Universal



**Universal
bremselyskontakt**

*Universal
bromsljuskontakt*
 Ref.nr. 46-42500.
 OEM nr. J45-82503-01.
 Varenr./art.nr. 174002

☐ 62,- ☐ 78,-



**Harley Davidson
stopplyskontakt**

*Bromsljuskontakt till
Harley Davidson.*
 Ref.nr. 07-11610.
 Varenr./art.nr. 174014

☐ 23,- ☐ 29,-



**Trykknapp kontakt
Tryckknapp brytare**

☐ Universal afbryder til
bl.a. relæer og horn.
 ☐ Brytare/kontakt till
bl.a. signalhorn, relä mm.

Ref. nr. 46-11600.
 Varenr./art.nr. 111085

☐ 87,- ☐ 109,-



**Omskifter
2 stegs omkopplare**

☐ Kort/langt lys
 ☐ Till hel och halvljus eller liknande.

Ref. nr. 46-11700
 Varenr./art.nr. 111086

☐ 87,- ☐ 109,-



☐ Universalhorn
☐ Universalhorn



Sort/Svart. 12 Volt.
 Ref.nr. 86-18022.

Diam. 90 mm
 Varenr./art.nr. 174202 ☐ 111,- ☐ 139,-

Sort/Svart. 6 Volt.
 Ref.nr. 86-18016.

Diam. 90 mm
 Varenr./art.nr. 174201 ☐ 111,- ☐ 139,-



Blank. 12 Volt.
 Ref.nr. 86-18322.

Diam. 70 mm
 Varenr./art.nr. 174200 ☐ 111,- ☐ 139,-

Blank (knallert). 6 Volt.
 Ref.nr. 86-18316.

Diam. 70 mm
 Varenr./art.nr. 174203 ☐ 111,- ☐ 139,-

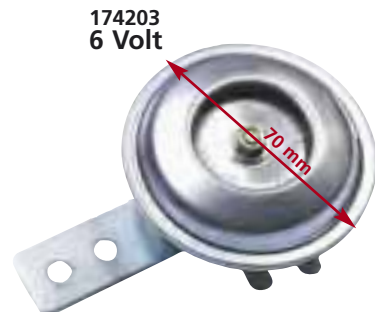
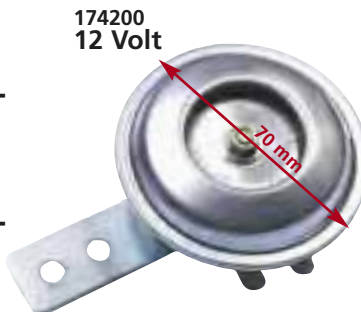

Forchromet/förkromad. 12 Volt.
 Ref.nr. 86-18342.

Diam. 70 mm
 Varenr./art.nr. 174205 ☐ 119,- ☐ 149,-





Paraboler og lygtehuse komplet

Kvalitets paraboler, alle E-mærket, og derfor ingen problemer ved syn.

Strålkastarinsats och lykthus komplett

Kvalitets strålkastar-insatser, alla E-märket, och därför inga problem vid besiktningen.

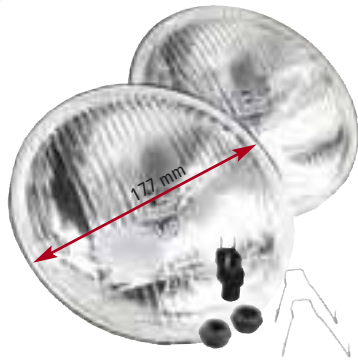

7" H4 parabol

Diam. 177 mm.

Til Honda, Kawasaki, Suzuki, Yamaha m.m.
"E"-mærket.

Varenr./art.nr. 173514

265,- 331,-



6" H4 parabol

Diameter 155 mm.

"E"-mærket.

Varenr./art.nr. 173515

282,- 353,-



5 3/4" H4 parabol

Diameter 143 mm.

"E"-mærket.

Varenr./art.nr. 173525

265,- 331,-

Lygtehus/Lykthus

CB 450 2-cyl. CB 500 T, 2-cyl.
CB 500 F/K, 4-cyl. CB 550 F/K, 4-cyl.
CB 750 K1-K7, 4-cyl.

OEM-nr. 61301-300-020

Sort

Varenr./art.nr. 171533 310,- 388,-

OEM-nr. 61301-300-000

Chrom.

Varenr./art.nr. 171534 313,- 391,-

Passer sammen med 173514.



Passer til 173514



Brug lygtekrans
171544



Forchromet lygtekrans komplet, 7"

Förkromad lyktkrans komplett, 7"

til Honda CB 500, CB 550,
CB 750 F/K.

OEM nr. 33101-300-673.

Ref.nr. 66.64330.

Varenr./art.nr. 171544

225,- 281,-



Forchromet lygtekrans komplet, 7"

Förkromad lyktkrans komplett, 7"

til Honda CB 650, CB 750 F/K/L,
CB 900 F/C, CBX 1000, GL 1100.

OEM nr. 33101-422-671 og/och 33101-460-671.

OEM nr. 33101-425-871.

Ref.nr. 66-64334.0.

Varenr./art.nr. 171543

225,- 281,-



Forchromet lygtekrans 7"

Förkromad lyktkrans 7"

til Kawasaki Z 650/900/1000 modeller.

OEM nr. 23006-038.

Ref.nr. 66-65030.

Varenr./art.nr. 171542

203,- 254,-

Stikord
Sökord
s. 2-5

Forhandlere
Aterforsaljare
s. 6-9

Tøj/hjelme
Klæder/
hjelmar
s. 11

Dæk
Däck
s. 83

Olie
Olja
s. 115

Kæde/
tandhjul
Kedjor/
drev
s. 145

Bremser
Broms
s. 187

Låse
Lås
s. 347

Batteri
Batterier
s. 355

Pakninger
Packningar
s. 377

Motordele
Motordelar
s. 411

Lejer
Lager
s. 435

Karburator
Förgasare
s. 467

El-dele/
Tænding
Elektrisk/
Tænding
s. 509

Blinklygter
Baglygter
Belysning
Baklygter
s. 611

Lyddæmper
Avgassystem
s. 651

Støddæmper
Støtdämpare
s. 681

Luft/
oliefilter
Luft/
oljefilter
s. 711

Kobling
Koppling
s. 769

Kabler
Wire
s. 803

Styr/greb
Styre/
handtag
s. 829

Spejle
og diverse
Speglar
och diverse
s. 867

Bøger/
værktøj
Böcker/
verktyg
s. 893

Paraboler og lygtehuse komplet

Kvalitets paraboler, alle E-mærket, og derfor ingen problemer ved syn.

Strålkastarinsats och lykthus komplett

Kvalitets strålkastar-insatser, alla E-märket, och därför inga problem vid besiktningen.



Passer til
173514

Universal LYGTEHUS og LYGTEKRANS Universal LYKTHUS och LYKTKRANS

Alle beslag til parabol medfølger.
Matsort med forchromet lygterand.

Ref.nr. 66-65010

Sort

Varenr./art.nr. 171540 396,- 495:-

Passer sammen med parabol 173514.



Passer til
173514

Forchromet LYGTEHUS og -KRANS 7" Förkromad LYKTHUS och -KRANS 7"

Til Kawasaki Z 650/900/1000.

OEM-nr. 23005-1015.

Ref.nr. 66-65042.

Varenr./art.nr. 171541 451,- 564:-

Passer sammen med parabol 173514.



Passer til 173514

LYGTEHUS til Honda CB 400 F LYKTHUS till Honda CB 400 F

OEM-nr. 61301-369-003B.

Ref.nr. 66-65042.

Varenr./art.nr. 171530 208,- 260:-

Passer sammen med 6" parabol 173515.



Forlygte til hjemmebyggere Strålkastare till hemma byggare

H03-66 B

Ref.nr. 310252

Varenr./art.nr. 173561 740,- 925:-

E-godkendt
 E-godkännande



**LYGTEHUS til Kawasaki
LYKTHUS till Kawasaki**

Til Z 500 og Z 1000.
OEM nr. 23005-1015/21
Ref.nr. 66-47120.
Varenr./art.nr. 171546
DK 358,- **SE 448,-**
Passer til lygtekrans 171542.
Passer til parabol 173514.



**LYGTEHUS til Kawasaki
LYKTHUS till Kawasaki**

OEM nr. 23005-1015/038
Ref.nr. 66-65012.
Varenr./art.nr. 171547
DK 402,- **SE 503,-**
Passer til parabol 173514.



**Universal lygte 7"
Universal lykta 7"**

DK Forchromet lygtehus og -krans
SE Förchromed lykthus och- krans
Ref. nr. 66-65040
Varenr./art.nr. 171545
DK 402,- **SE 503,-**
Passer til parabol 173514.



**Forlygte, komplet
Framlykta, komplett**

DK Universal lygte til hjemmebyggere
SE Universal lykta till hembyggare
Ref. nr. 378565
Varenr./art.nr. 171548
DK 630,- **SE 788,-**



**Lygteholder
Lykthållare**

Ø 35-36 mm.
Ref. nr. 1083.91
Varenr./art.nr. 111011
DK 389,- **SE 486,-**



**Lygteholder
Lykthållare**

Ø 37-39 mm.
Ref. nr. 1084.91
Varenr./art.nr. 111014
DK 389,- **SE 486,-**



**Universal lygteholder
Universal lykthållare**

DK Lygteholdersæt, chrom. Universal størrelse.
Lygteholderen er 150 cm i total længde.
SE Föchromade hållare i universal storlek.
15 cm total längd.
Ref. nr. 66-35800
Varenr./art.nr. 111056
DK 67,- **SE 84,-**



**Universal lygteholder
Universal lykthållare**

DK Kan anvendes til 31-41 mm gaffelben.
SE Kan används til 31-41 mm gaffelben.
Ref. nr. 66-35830
Varenr./art.nr. 111040
DK 249,- **SE 311,-**

Stikord
Søkkord
s. 2-5

Forhandlere
Aterforsaljare
s. 6-9

Tøj/hjelme
Klæder/
hjelmar
s. 11

Dæk
Dækk
s. 83

Olje
Olja
s. 115

Kæde/
tandhjul
Kedjor/
drev
s. 145

Bremser
Broms
s. 187

Låse
Lås
s. 347

Batteri
Batterier
s. 355

Pakninger
Packingar
s. 377

Motordele
Motordelar
s. 411

Lejer
Lager
s. 435

Karburator
Förgasare
s. 467

**El-dele/
Tænding
Elektrisk/
Tænding
s. 509**

Blinklygter
Baglygter
Belysning
Baklykter
s. 611

Lyddæmper
Avgassystem
s. 651

Støddæmper
Støtdåmpare
s. 681

Luft/
oliefilter
Luft/
oljefilter
s. 711

Kobling
Koppling
s. 769

Kabler
Wire
s. 803

Styr/greb
Styre/
handtag
s. 829

Spejle
og diverse
Speglar
och diverse
s. 867

Bøger/
værktøj
Böcker/
verktyg
s. 893



**Special lygte 155 mm
Special lykta 155 mm**

■ H4, med kort og langt lys og blå kontrollampe foroven. Chrom. Til lygteholder 111056.
■ Hel och halvljus, H4. Sidofästen. Blå kontrollampa på ovansidan. Förokromad. Till hållare 111056.
Ref. nr. 66-84101
Varenr./art.nr. 111050
■ 605,- ■ 756:-



**Special lygte 120 mm
Special lykta 120 mm**

■ Kort og langt lys. Chrom.
Pære: 500285B / 12V/25-25W
■ Hel och halvljus. Förokromad.
Glödlamp: 500285B / 12V/25-25W
Ref. nr. 66-84121
Varenr./art.nr. 111051
■ 523,- ■ 654:-



**Special lygte 155 mm
Special lykta 155 mm**

■ H4, med kort og langt lys og blå kontrollampe foroven. Chrom.
■ Hel och halvljus, H4. Blå kontrollampa på ovansidan. Förokromad.
Ref. nr. 66-84151
Varenr./art.nr. 111052
■ 657,- ■ 821:-



**Special lygte 120 mm
Special lykta 120 mm**

■ 50 W pærer. E-mærket.
■ 50W lampa. E-märkt. Förokromad.
Ref. nr. 66-84122
Varenr./art.nr. 111053
■ 630,- ■ 788:-



**Lygteskygge
Keps**

■ Til 7" lygte. Chrom.
■ Förokromad keps. Passar 7" lykta.
Ref. nr. 66-10710
Varenr./art.nr. 111054
■ 79,- ■ 99:-



**Lygteskygge
Keps**

■ Til 5 3/4" lygte. Chrom.
■ Förokromad keps. Passar till 5 3/4" lykta.
Ref. nr. 66-10721
Varenr./art.nr. 111055
■ 66,- ■ 83:-

**Fatning til positionslys universal
Kabel för blinkers universal**

Ref.nr. ST-19002.
Varenr. 121709

■ 95,- ■ 119:-





VARENDR.	Beskrivelse	Sokkeltype	Farve			Antal pr. ks.	Stk.pris
500250	12V / 1,2W	W2x4, 6D, T5	Klar		2,5 x 4,5 mm	10	15,- 19,-

VARENDR.	Beskrivelse	Sokkeltype	Farve			Antal pr. ks.	Stk.pris
500251	12V / 3,0W	W2, 1x9, 5D, T10	Klar		3,5 x 9 mm	10	13,- 16,-
500252	12V / 5,0W	W2, 1x9, 5D	Klar			10	13,- 16,-
500261E	12V / 10,0W	W2, 1x9, 5D	Klar			10	17,- 21,-

VARENDR.	Beskrivelse	Sokkeltype	Farve			Antal pr. ks.	Stk.pris
500240	12V / 2,0W	BA7S	Klar		7 mm	10	13,- 16,-

VARENDR.	Beskrivelse	Sokkeltype	Farve			Antal pr. ks.	Stk.pris
500144	6V / 3,0W	BA9S	Klar		9 mm	10	15,- 19,-
500143A	6V / 5,0W	BA9S	Klar			10	15,- 19,-
500241	12V / 2,0W	BA9S	Klar			10	15,- 19,-
500242AA	12V / 5,0W	BA9S	Blå			10	26,- 33,-
500242C	12V / 4,0	BA9S	Rød			10	19,- 24,-
500242CR	12V / 4,0	BA9S	Rød			10	26,- 33,-
500243A	12V / 5,0W	BA9S	Klar			10	15,- 19,-

VARENDR.	Beskrivelse	Sokkeltype	Farve			Antal pr. ks.	Stk.pris
500142	6V / 4,0W	BA9S	Klar		9 mm	10	15,- 19,-
500242	12V / 4,0W	BA9S	Klar			10	13,- 16,-

VARENDR.	Beskrivelse	Sokkeltype	Farve			Antal pr. ks.	Stk.pris
500160	6V / 5,0W	BA15S	Klar		15 mm	10	15,- 19,-
500167	6V / 8,0W	BA15S	Klar			10	15,- 19,-
500161	6V / 10,0W	BA15S	Klar			10	15,- 19,-
500260	12V / 5,0W	BA15S	Klar			10	15,- 19,-
500261	12V / 10,0W	BA15S	Klar			10	15,- 19,-
500261YO	12V / 10,0W	BA15S	Orange			10	19,- 24,-
500261CB	12V / 10,0W	BA15S	Blå			10	19,- 24,-

VARENDR.	Beskrivelse	Sokkeltype	Farve			Antal pr. ks.	Stk.pris
500164	6V / 21,0W	BA15S	Klar		15 mm	10	15,- 19,-
500264	12V / 21,0W	BA15S	Klar			10	19,- 24,-
500264Y	12V / 21,0W	BA15S/C-6	Orange			10	19,- 24,-

- Stikord Sökord s. 2-5
- Forhandlere Aterforsaljare s. 6-9
- Toj/hjelme Kläder/hjälmar s. 11
- Dæk Däck s. 83
- Olie Olja s. 115
- Kæde/tandhjul Kedjor/drev s. 145
- Bremser Broms s. 187
- Låse Lås s. 347
- Batteri Batterier s. 355
- Pakninger Packningar s. 377
- Motordele Motordelar s. 411
- Lejer Lager s. 435
- Karburator Förgasare s. 467
- El-dele/ Tænding Elektrisk/Tænding s. 509
- Blinklygter Baglygter Belysning Baklykter s. 611
- Lyddæmper Avgassystem s. 651
- Støddæmper Støtdæmpere s. 681
- Luft/oliefilter Luft/oljefilter s. 711
- Kobling Koppling s. 769
- Kabler Wire s. 803
- Styr/greb Styre/handtag s. 829
- Spejle og diverse Speglar och diverse s. 867
- Bøjer/værktøj Bøker/verktøy s. 893

VAREN.R.	Beskrivelse	Sokkeltype	Farve			Antal pr. ks.	Stk.pris
500165B	6V / 20/5W	BAY15D	Klar			10	15,- 19,-
500165	6V / 21/5W	BAY15D	Klar			10	15,- 19,-
500265	12V / 21/5W	BAY15D	Klar			10	17,- 21,-
500265CR	12V / 21/5W	BAY15D	Rød			10	17,- 21,-
500265YO	12V / 21/5W	BAY15D	Orange			10	17,- 24,-
500265CB	12V / 21/5W	BAY15D	Blå			10	19,- 24,-



VAREN.R.	Beskrivelse	Sokkeltype	Farve			Antal pr. ks.	Stk.pris
500180	6V / 15.0W	P26S	Klar			5	18,- 23,-
500180Y	6V / 15.0W	P26S	gul			5	18,- 23,-
500187	6V / 20.0W	P26S	Klar			5	17,- 21,-
500280	12V / 15.0W	P26S	Klar			5	19,- 24,-
500280Y	12V / 15.0W	P26S	gul			5	26,- 33,-

VAREN.R.	Beskrivelse	Sokkeltype	Farve			Antal pr. ks.	Stk.pris
500180AH	6V / 15,0W	P26S - Halogen	Klar			1	50,- 63,-
500280AH	12V / 15,0W	P26S - Halogen	Klar			1	51,- 64,-

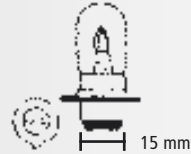
VAREN.R.	Beskrivelse	Sokkeltype	Farve			Antal pr. ks.	Stk.pris
500185B	6V / 25/25W	P15D	Klar			1	20,- 25,-
500285B	12V / 25/25W	P15D	Klar			1	37,- 46,-

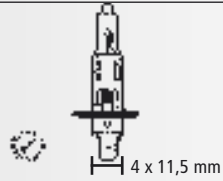
VAREN.R.	Beskrivelse	Sokkeltype	Farve			Antal pr. ks.	Stk.pris
500185BH	6V / 25/25W	P15D Halogen	Klar			1	51,- 64,-
500285BH	12V / 25/25W	P15D Halogen	Klar			1	61,- 64,-

VAREN.R.	Beskrivelse	Sokkeltype	Farve			Antal pr. ks.	Stk.pris
500221	12V / 55.0W	P14, 5S (H1)	Klar			1	29,- 36,-
500221C	12V / 55.0W	P14, 5S (H1)	Blå			1	79,- 99,-
500291	12V / 100.0W	P14, 5S (H1)	Klar			1	51,- 64,-

VAREN.R.	Beskrivelse	Sokkeltype	Farve			Antal pr. ks.	Stk.pris
500223	12V / 55.0W	PK22S (H3)	Klar			1	30,- 38,-
500223C	12V / 55.0W	PK22S (H3)	Blå			1	79,- 99,-
500293	12V / 100.0W	PK22S (H3)	Klar			1	51,- 64,-

VAREN.R.	Beskrivelse	Sokkeltype	Farve			Antal pr. ks.	Stk.pris
500220	12V / 60/55W	P43T (H4)	Klar			1	48,- 60,-
500220A	12V / 35/35W	PX43T (H4) Halogen	Klar			1	55,- 69,-
500220C	12V / 60/55W	P43T (H4)	Blå			1	131,- 164,-
500296	12V / 100/80W	P43T (H4)	Klar			1	51,- 64,-

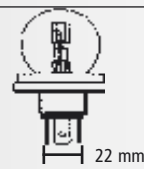
VAREN.R.	Beskrivelse	Sokkeltype	Farve			Antal pr. ks.	Stk.pris
500210	12V / 45/40W	P45T	Klar			1	26,- 33,-

VAREN.R.	Beskrivelse	Sokkeltype	Farve			Antal pr. ks.	Stk.pris
500227	12V / 55,0W	PX26D (H7)	Klar		18 mm	1	79,- 99,-

Stikord Søkord s. 2-5
Forhandlere Aterforsaljare s. 6-9

VAREN.R.	Beskrivelse	Sokkeltype	Farve			Antal pr. ks.	Stk.pris
500211H	12V / 25/25W	BA20D Halogen	Klar		22 mm	1	103,- 129,-



Tøj/hjelme Klæder/hjælmar s. 11
Dæk Dæck s. 83

VAREN.R.	Beskrivelse	Sokkeltype	Farve			Antal pr. ks.	Stk.pris
500114	6V / 15/15W	BA20D	Klar		22 mm	1	21,- 26,-
500114B	6V / 20/20W	BA20D	Klar			1	21,- 26,-
500111	6V / 25/25W	BA20D	Klar			1	21,- 26,-
500211	12V / 25/25W	BA20D	Klar			1	26,- 33,-
500212	12V / 35/35W	BA20D	Klar			1	18,- 23,-
500212C	12V / 35/35W	BA20D	Blå			1	58,- 73,-
500212Y	12V / 35/35W	BA20D	Gul			1	103,- 129,-
500213	12V / 45/40W	BA20D	Klar			1	23,- 29,-

Olje Olja s. 115
Kæde/ tandhjul Kedjor/drev s. 145

VAREN.R.	Beskrivelse	Sokkeltype	Farve			Antal pr. ks.	Stk.pris
500212AH	12V / 35/35W	BA20D Halogen	Klar		20 mm	1	103,- 129,-

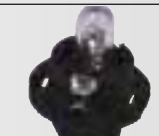
Bremser Broms s. 187
Låse Lås s. 347

VAREN.R.	Beskrivelse	Sokkeltype	Farve			Antal pr. ks.	Stk.pris
500250B	12V / 1,2W	BX8, 4D	Klar			10	17,- 21,-

Batteri Batterier s. 355
Pakninger Pæckningar s. 377

VAREN.R.	Beskrivelse	Sokkeltype	Farve			Antal pr. ks.	Stk.pris
111151	12V / 23/8W		Klar		15 mm	5	14,- 18,-

Motordele Motordelar s. 411
Lejer Lager s. 435

VAREN.R.	Beskrivelse	Sokkeltype	Farve			Antal pr. ks.	Stk.pris
500224A	12V / 35,0W	PGJ19-1 - Halogen	Klar		15 mm	1	147,- 184,-



Karburator Førgasare s. 467
El-dele/ Tænding Elektrisk/ Tænding s. 509

VAREN.R.	Beskrivelse	Sokkeltype	Farve			Antal pr. ks.	Stk.pris
500224B	12V / 55,0W	PGJ19-2 - Halogen	Klar		H8 15 mm	1	147,- 184,-

Blinklygter Baglygter Belysning Bækllykter s. 611
Lyddæmper Avgassystem s. 651

VAREN.R.	Beskrivelse	Sokkeltype	Farve			Antal pr. ks.	Stk.pris
500254B	12V / 1,2W	BZ8.3d	Klar		H11 15 mm	1	17,- 21,-

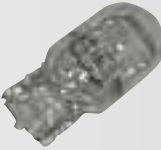
Støddæmper Støtdæmpare s. 681
Luft-/ oliefilter Luft-/ oljefilter s. 711

VAREN.R.	Beskrivelse	Sokkeltype	Farve			Antal pr. ks.	Stk.pris
500264G	12V / 21,0W	W3x16d	Klar		15 mm	1	26,- 33,-



Kobling Koppling s. 769
Kabler Wire s. 803

Styr/greb Styre/handtag s. 829
Spejle og diverse Spegler och diverse s. 867

Bøjer/ værktøj Bøcker/ værktyg s. 893



VAREN.R.	Beskrivelse	Sokkeltype	Farve	Diodepære	Antal pr. ks.	Stk.pris
600264B	12V / W	BA15S	Blå	 	1	137,- 171,-
600264G	12V / W	BA15S	Grøn		1	103,- 129,-
600264R	12V / W	BA15S	Rød		1	103,- 129,-
600264W	12V / W	BA15S	Hvid		1	103,- 129,-
600264Y	12V / W	BA15S	Gul		1	103,- 129,-

VAREN.R.	Beskrivelse	Sokkeltype	Farve	Diodepære	Antal pr. ks.	Stk.pris
600265B	12V / W	BAY15D	Blå	 	1	153,- 191,-
600265G	12V / W	BAY15D	Grøn		1	126,- 158,-
600265W	12V / W	BAY15D	Hvid		1	126,- 158,-
600265Y	12V / W	BAY15D	Gul		1	103,- 129,-

VAREN.R.	Beskrivelse	Sokkeltype	Farve	Diodepære	Antal pr. ks.	Stk.pris
121403	12V / 21,5W	BAY15D	Rød	 	10	17,- 21,-

VAREN.R.	Beskrivelse	Sokkeltype	Farve	Diodepære	Antal pr. ks.	Stk.pris
500261	12V / 10,0W	BA15S	Klar	 	10	15,- 19,-
500261YO	12V / 10,0W	BA15S	Orange		10	19,- 24,-

VAREN.R.	Beskrivelse	Sokkeltype	Farve	Diodepære	Antal pr. ks.	Stk.pris
121405	12V / 21,0W	BAU15S SC	Orange		1	28,- 35,-

VAREN.R.	Beskrivelse	Sokkeltype	Farve	Diodepære	Antal pr. ks.	Stk.pris
500264	12V / 21,0W	BA15S	Klar	 	10	19,- 24,-

VAREN.R.	Beskrivelse	Sokkeltype	Farve	Diodepære	Antal pr. ks.	Stk.pris
121401	12V / 23,0W		Klar		10	15,- 19,-

VAREN.R.	Beskrivelse	Sokkeltype	Farve	Diodepære	Antal pr. ks.	Stk.pris
121402	12V / 23,0W		Klar		10	15,- 19,-

VAREN.R.	Beskrivelse	Sokkeltype	Farve	Diodepære	Antal pr. ks.	Stk.pris
121404	12V / 23,0W		Orange		10	28,- 35,-